



OFFERING THE  
VALUE OF CHOICE



10

2003-2013

YEARS

[www.ERParts.com](http://www.ERParts.com)

 "Like" us on Facebook!

# Table of Contents

## **Electric Cooking**

Elements, Bake and Broil.....	2-14
Elements, Surface.....	21-23
Elements, Surface (Radiant for glass cooktops).....	22
Pans, Drip.....	24-25
Receptacles, Surface Element.....	20
Switches, Infinite.....	26-31
Thermostats, Electric Oven.....	15-19

## **Gas Cooking**

Burners.....	34-42
Grates, Top Burner.....	32-33
Harnesses, Pilot.....	104
Igniters, Oven Glow.....	70-71
Igniters, Oven Spark.....	72
Igniters, Top Burner Spark.....	43-44
Modules, Spark.....	45-51
Pilots, Oven.....	67
Probes, Oven Temperature.....	73
Regulators, Pressure.....	74-75
Switches, Top Burner Spark.....	56-60
Thermostats, E/G (Electric/Gas).....	68-69
Thermostats, Gas Oven.....	61-63
Valves, Top Burner.....	52-55
Valves, Oven Safety.....	64-66

## **General Cooking**

Bulbs, Appliance.....	116-122
Filters, Over The Range.....	106-115
Gaskets, Oven Door.....	98-99
Hinges, Oven Door.....	97
Knobs.....	77-93
Knobs, Universal.....	76
Latches, Door.....	73
Miscellaneous, Cooking.....	103-105
Parts & Accessories, Small Appliance.....	100-102
Racks, Oven.....	94-96
Springs, Oven Door.....	103

## **Microwave**

Buttons, Door Open.....	129
Buttons, Select.....	151
Capacitors, High Voltage.....	125
Clips, Waveguide Cover Retaining.....	149
Couplings, Turntable.....	141
Covers, Waveguide & Stirrer.....	148-149
Diodes.....	126
Fuses.....	130
Fuses, Thermal.....	138
Handles, Door.....	127
Holder, Fuse.....	152
Inverters.....	152
Latchboards, Body.....	151
Latchkeys, Door.....	128
Levers, Door Open.....	150
Magnetrons.....	131-136
Miscellaneous, Microwave.....	150-152
Motors, Turntable/Stirrer.....	142-143
Sheets, Inner Door.....	152
Springs.....	150
Supports, Rack.....	150
Supports, Turntable.....	144-145
Switches.....	137
Thermistors, Sensors, Varistors.....	151-152
Thermostats.....	140
Transformers.....	139
Trays, Turntable.....	146-147

<b>Dishwasher</b> .....	153-160
Disposal.....	16

## **HVAC**

Accessories, Air Conditioning.....	256-257
Belts, HVAC.....	254-255
Humidifiers	
Filters, Wicks, Pads.....	248-252
Igniters, Furnace.....	243-246
Parts, Furnace.....	247
Supplies, HVAC.....	253
Super Seal.....	256-257

## **Laundry**

Dryer	
Belts.....	161
Parts.....	162-180
Thermostats.....	162
Dryer Venting & Accessories.....	178-180
Laundry Miscellaneous.....	194-195
Washer	
Belts.....	181
Hoses.....	192-193
Parts.....	182-191

## **Motors**

550 Series.....	240
600 Series.....	241-242
Motors, Vent Hood/Bath Fan.....	242
For Evaporator Motors <i>see Refrigerator</i>	

## **Refrigerator**

Bars, Door.....	204-205
Bins, Refrigerator.....	206
Capacitors.....	228
Controls, Cold.....	202-203
Driers, Spun Copper.....	213
Endcaps.....	206-207
Filters, Water.....	200-201
Gaskets, Door.....	219-224
Heaters, Defrost.....	208-210
Makers, Ice.....	196-199
Miscellaneous, Refrigerator.....	229-230
Motors, Evaporator.....	214-218
Overloads.....	227
Relay/Overloads.....	226
Relays, PTC.....	228
Starts, Power.....	225
Thermostats, Defrost.....	211
Timers, Defrost.....	212

## **Service Aids & Tools**

Adhesives.....	231
Cleaners.....	232
Lubricants.....	233
Paints.....	235
Supplies.....	234-235
Tools.....	236-239

# BAKE AND BROIL ELEMENTS

Engineered to OEM specifications, ERP utilizes world-class manufacturers for Bake & Broil elements.

## Measurement Key for Elements

- A = Measurement between terminals
- B = Measurement between terminal end and mounting bracket
- C = Measurement between mounting bracket and end of element
- D = Measurement of element width
- E = Measurement between indentation of element and end of element

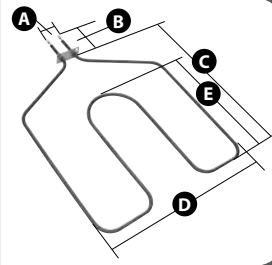

## Order No. ERB44K5009

Watts: 3400 Volts: 240

- A = 1-1/2"
- B = 2-5/8"
- C = 15-5/8"
- D = 13-3/4"

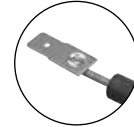

.250" male terminal push-in connection

Also fits: GE #WB44K5009

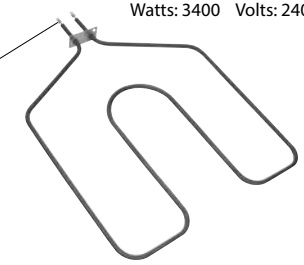

## Order No. ERB44K5012

Watts: 2850 Volts: 240

- A = 3"
- B = 4"
- C = 16"
- D = 17"



.250" male terminal push-in connection

Also fits: GE #WB44K5012, Gemline #RP44K5012, Chromalox/Supco #CH44K5012, Zoppas #TS44K5012

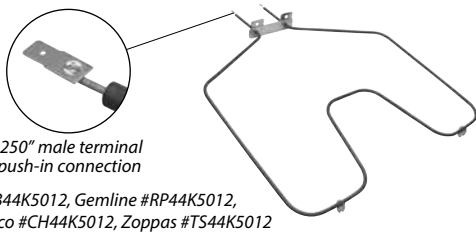

## Order No. ERB44K5013

Watts: 2000 Volts: 240

- A = 1-3/4"
- B = 3"
- C = 16"
- D = 13-3/4"
- E = 7-3/4"

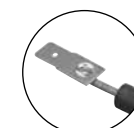

.250" male terminal push-in connection

Also fits: GE #WB44K5013

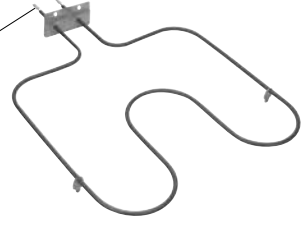

## Order No. ERB44K10002

Watts: 3410 Volts: 240

- A = 1-3/4"
- B = 2-11/16"
- C = 16-7/8"
- D = 14"



.250" male terminal push-in connection

Also fits: GE #WB44K10002

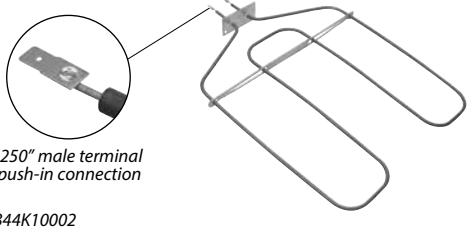

## Order No. ERB44K10005

Watts: 2585 Volts: 240

- A = 3"
- B = 2-1/2"
- C = 15-1/4"
- D = 17-3/4"



.250" male terminal push-in connection

Also fits: GE #WB44K10005

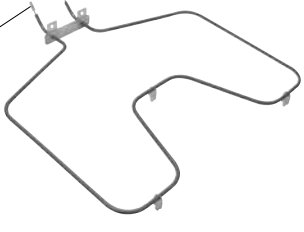

## Order No. ERB44K10019

Watts: 2000 Volts: 240

- A = 2"
- B = 3"
- C = 14"
- D = 13-1/4"
- E = 8-1/4"

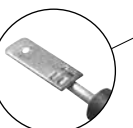

.250" male terminal push-in connection

Also fits: GE #WB44K10019

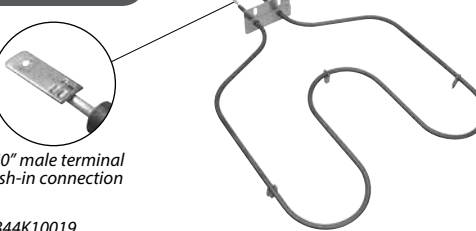

## Order No. ERB44T10009

Watts: 3410 Volts: 240

- A = 1-1/2"
- B = 2-1/2"
- C = 17"
- D = 11-3/4"
- E = 13-1/4"

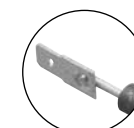

.250" male terminal push-in connection

Also fits: GE #WB44T10009

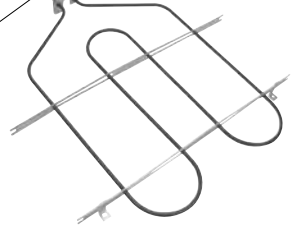

## Order No. ERB44T10010

Watts: 2585 Volts: 240

- A = 3"
- B = 2-3/4"
- C = 17"
- D = 18"

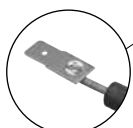

.250" male terminal push-in connection

Also fits: GE #WB44T10010

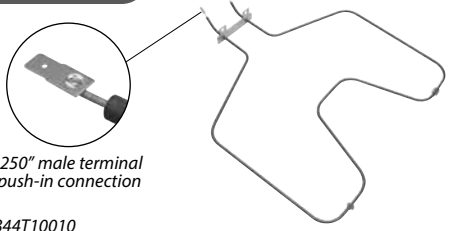

## Order No. ERB44T10011

Watts: 3410 Volts: 240

- A = 3"
- B = 2-1/4"
- C = 16-7/8"
- D = 17-3/4"

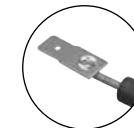

.250" male terminal push-in connection

Also fits: GE #WB44T10011

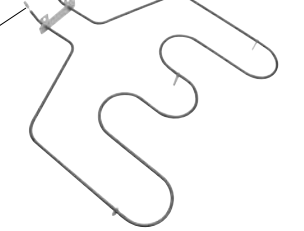

# BAKE AND BROIL ELEMENTS

Engineered to OEM specifications, ERP utilizes world-class manufacturers for Bake & Broil elements.

## Order No. ERB44T10014

Watts: 3800 Volts: 240

- A = 3"
- B = 2-5/8"
- C = 16-3/8"
- D = 18-7/8"

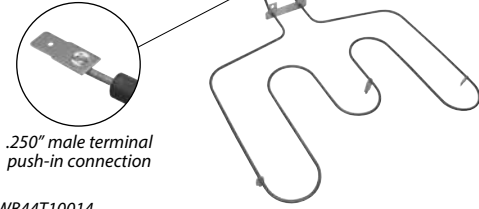

.250" male terminal push-in connection

Also fits: GE #WB44T10014

## Order No. ERB44T10017

Watts: 2000 Volts: 240

- A = 2"
- B = 2-7/8"
- C = 16"
- D = 14-1/4"

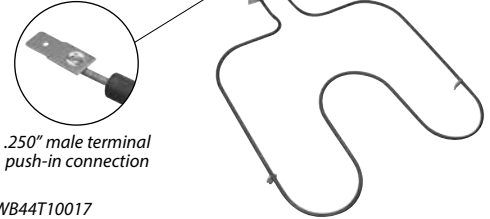

.250" male terminal push-in connection

Also fits: GE #WB44T10017

## Order No. ERB44T10018

Watts: 3410 Volts: 240

- A = 2"
- B = 2-1/2"
- C = 15-1/2"
- D = 18-1/8"

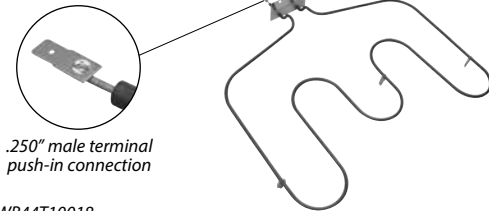

.250" male terminal push-in connection

Also fits: GE #WB44T10018

## Order No. ERB44X126

Watts: 3000 Volts: 250

- A = 1"
- B = 1-5/8"
- C = 14-5/8"
- D = 19-5/8"

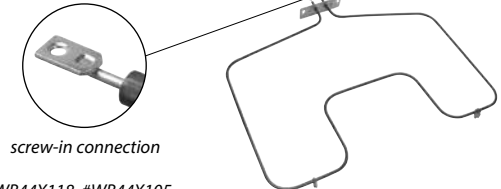

screw-in connection

Also fits: GE #WB44X118, #WB44X105, #WB44X112, #WB44X120, #WB44X133 Chromalox/Supco #CH44X126

## Order No. ERB44X127

Watts: 2000/1500 Volts: 240/208

- A = 1-1/4"
- B = 1-5/8"
- C = 15"
- D = 9-1/4"

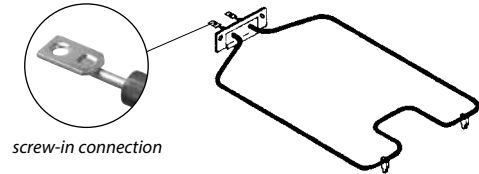

screw-in connection

Also fits: GE #WB44X196, Gemline #RP44X127, Chromalox/Supco #CH44X127, Zoppas #TS44X127

## Order No. ERB44X134

Watts: 3000 Volts: 250

- A = 1-1/4"
- B = 2-1/2"
- C = 15-7/8"
- D = 12"
- E = 12-5/8"

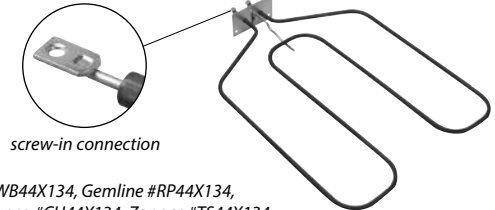

screw-in connection

Also fits: GE #WB44X134, Gemline #RP44X134, Chromalox/Supco #CH44X134, Zoppas #TS44X134

## Order No. ERB44X139

Watts: 3000/2250 Volts: 240/208

- A = 1-1/2"
- B = 2"
- C = 17-3/4"
- D = 10-1/2"

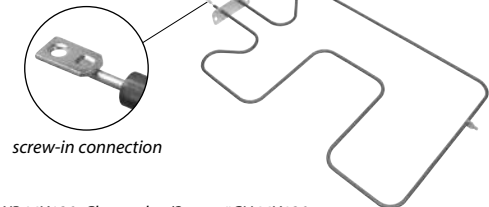

screw-in connection

Also fits: GE #WB44X139, Chromalox/Supco #CH44X139

## Order No. ERB44X173

Watts: 3400 Volts: 250

- A = 1-1/4"
- B = 1-3/8"
- C = 15-1/2"
- D = 11-3/4"
- E = 12-1/4"

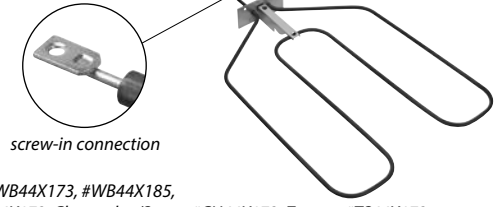

screw-in connection

Also fits: GE #WB44X173, #WB44X185, Gemline #RP44X173, Chromalox/Supco #CH44X173, Zoppas #TS44X173

## Order No. ERB44X195

Watts: 1800/1350 Volts: 240/208

- A = 1-1/2"
- B = 2-1/4"
- C = 18-3/4"
- D = 6-1/8"

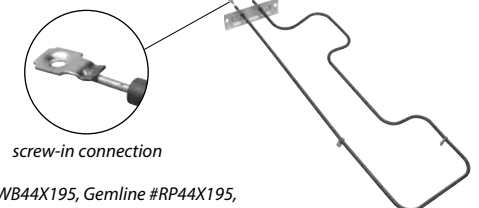

screw-in connection

Also fits: GE #WB44X195, Gemline #RP44X195, Chromalox/Supco #CH44X195, Zoppas #TS44X195

## Order No. ERB44X200

Watts: 3100/2330 Volts: 250/208

- A = 1-1/4"
- B = 2-1/2"
- C = 16-1/4"
- D = 13-3/8"

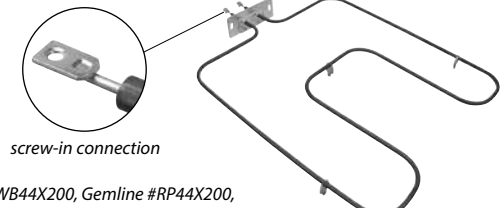

screw-in connection

Also fits: GE #WB44X200, Gemline #RP44X200, Chromalox/Supco #CH44X200, Zoppas #TS44X200

COOKING



# BAKE AND BROIL ELEMENTS

Engineered to OEM specifications, ERP utilizes world-class manufacturers for Bake & Broil elements.

## Measurement Key for Elements

- A = Measurement between terminals
- B = Measurement between terminal end and mounting bracket
- C = Measurement between mounting bracket and end of element
- D = Measurement of element width
- E = Measurement between indentation of element and end of element

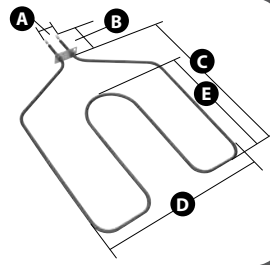

## Order No. ERB44X228

Watts: 3000/2250 Volts: 240/208

- A = 1-3/4"
- B = 4"
- C = 15-1/2"
- D = 18-3/8"
- E = 5-1/2"

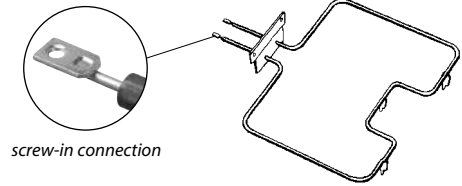

screw-in connection

Also fits: GE #WB44X228, Gemline #RP44X228, Zoppas #TS44X228

## Order No. ERB44X232

Watts: 2585 Volts: 250

- A = 12-1/2"
- B = 4"
- C = 14-5/8"
- D = 12-1/2"
- E = 12-1/2"

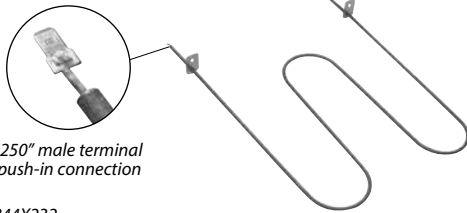

.250" male terminal push-in connection

Also fits: GE #WB44X232

## Order No. ERB44X5043

Watts: 3000 Volts: 250

- A = 1-1/4"
- B = 1-3/8"
- C = 15"
- D = 13-1/4"
- E = 7-3/4"

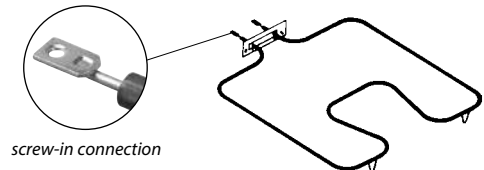

screw-in connection

Also fits: GE #WB44X5043, Gemline #RP44X5043, Chromalox/Supco #CH44X5043, Zoppas #TS44X5043

## Order No. ERB44X5074

Watts: 2750/2065 Volts: 240/208

- A = 1-3/4"
- B = 2-1/4"
- C = 16"
- D = 12"
- E = 12-1/2"

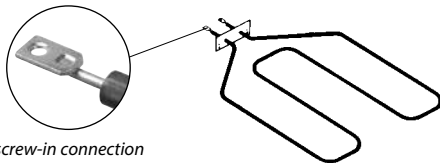

screw-in connection

Also fits: GE #WB44X5074, Gemline #RP44X5074, Chromalox/Supco #CH44X5074, Zoppas #TS44X5074GWB

## Order No. ERB44X5082

Watts: 2585/1940 Volts: 250/208

- A = 1-1/4"
- B = 2-1/2"
- C = 14-3/4"
- D = 17-5/8"
- E = 6-1/2"

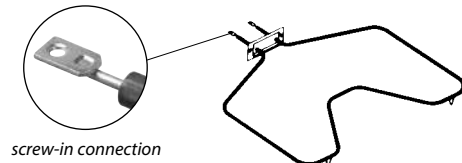

screw-in connection

Also fits: GE #WB44X5082, Gemline #RP44X5082, Chromalox/Supco #CH44X5082, Zoppas #TS44X5082

## Order No. ERB44X5099

Watts: 2585/1940 Volts: 250/208

- A = 1-1/4"
- B = 1-5/8"
- C = 16"
- D = 18"
- E = 6-1/2"

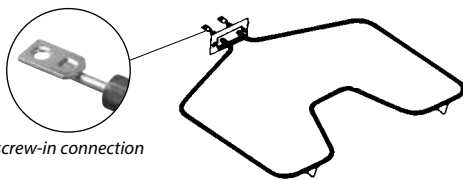

screw-in connection

Also fits: GE #WB44X5099, Gemline #RP44X5099, Chromalox/Supco #CH44X5099, Zoppas #TS44X5099

## Order No. ERB44X10009

Watts: 2585/1940 Volts: 240/208

- A = 1-3/4"
- B = 3-1/4"
- C = 15-1/2"
- D = 18"
- E = 6-1/2"

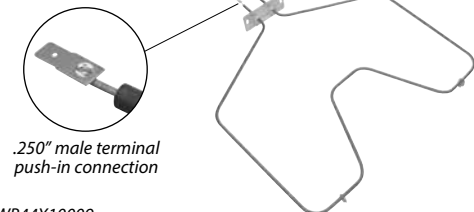

.250" male terminal push-in connection

Also fits: GE #WB44X10009

## Order No. ERB44X10013

Watts: 3410 Volts: 240

- A = 1-1/2"
- B = 3"
- C = 15-3/8"
- D = 17-5/8"
- E = 8-3/8"

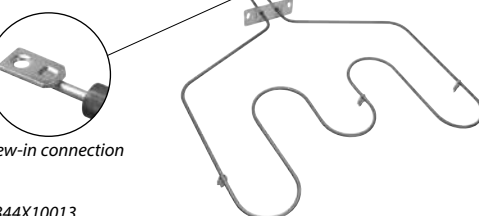

screw-in connection

Also fits: GE #WB44X10013

## Order No. ERB44X10015

Watts: 3410 Volts: 240

- A = 1-3/4"
- B = 2-5/8"
- C = 16"
- D = 12-5/8"

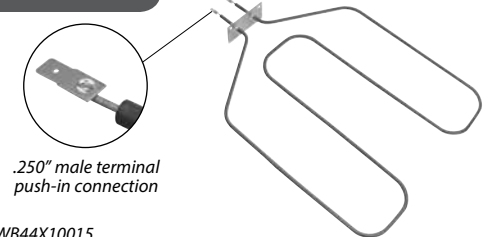

.250" male terminal push-in connection

Also fits: GE #WB44X10015

# BAKE AND BROIL ELEMENTS

Engineered to OEM specifications, ERP utilizes world-class manufacturers for Bake & Broil elements.

## Order No. ERB44X10016

Watts: 3410 Volts: 240

- A = 1-1/2"
- B = 3"
- C = 15-1/2"
- D = 18-5/8"

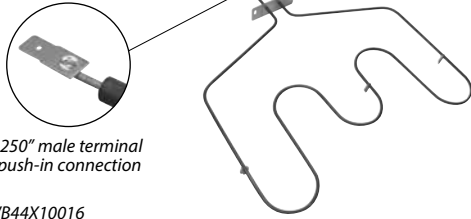

Also fits: GE #WB44X10016

## Order No. ERB44X10027

Watts: 2300 Volts: 240

- A = 2-3/8"
- B = 1-1/2"
- C = 15-1/2"
- D = 10-1/8"

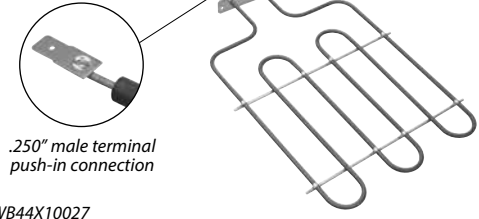

Also fits: GE #WB44X10027

## Order No. ERB44X10028

Watts: 2000 Volts: 240

- A = 13-1/4"
- B = 1-1/2"
- C = 13-1/4"
- D = 13-1/4"

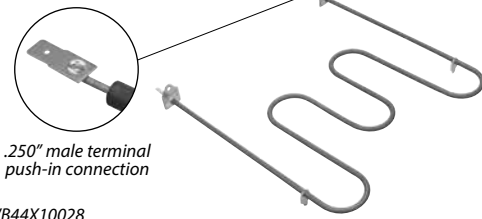

Also fits: GE #WB44X10028

## Order No. ERB550

Watts: 2200/1650 Volts: 240/208

- A = 13"
- B = 2-3/4"
- C = 16-5/8"
- D = 16"

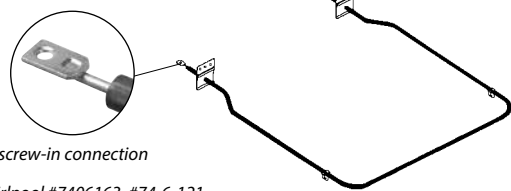

Also fits: Whirlpool #7406163, #74-6-121, Chromalox/Supco #CH550, Gemline #RP550, Zoppas #TS550

## Order No. ERB580

Watts: 2300/1725 Volts: 240/208

- A = 13-5/8"
- B = 1-5/8"
- C = 15-7/8"
- D = 13-5/8"

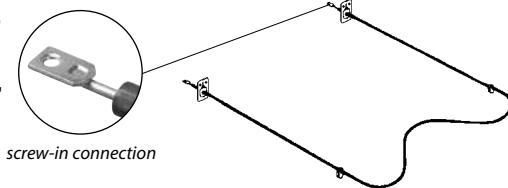

Also fits: Chromalox/Supco #ROU-N, Gemline #RP580, Zoppas #TS580

## Order No. ERB584

Watts: 2400/1661 Volts: 250/208

- A = 6-1/4"
- B = 2-7/8"
- C = 12-3/4"
- D = 18-1/2"
- E = 7-1/2"

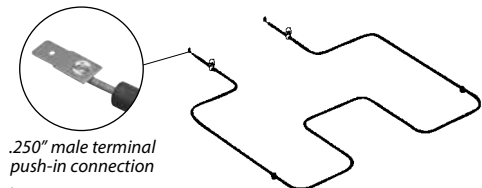

Also fits: Electrolux #221T017P01, Chromalox/Supco #CH584, Gemline #RP584, Zoppas #TS584

## Order No. ERB613

Watts: 2300/1725 Volts: 240/208

- A = 14-1/8"
- B = 1-7/8"
- C = 17-5/8"
- D = 14-1/8"

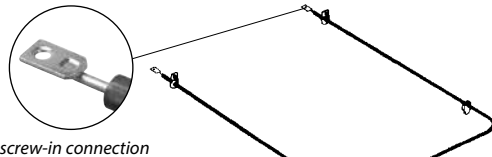

Also fits: Electrolux #221T004P09, Gemline #RP613, Chromalox/Supco #CH613, Zoppas #TS613

## Order No. ERB620

Watts: 2200 Volts: 240

- A = 12-3/4"
- B = 2-3/8"
- C = 16"
- D = 12-3/4"

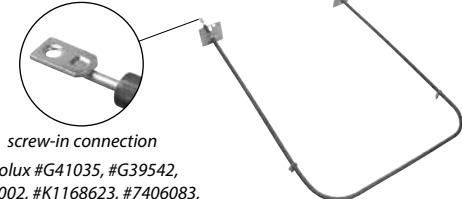

Also fits: Electrolux #G41035, #G39542, Whirlpool #03002, #K1168623, #7406083, Chromalox/Supco #CH620, Suburban #R23220, Gemline #RP620, Zoppas #TS620

## Order No. ERB640

Watts: 1500 Volts: 240

- A = 2"
- B = 1"
- C = 17-1/4"
- D = 2-1/8"

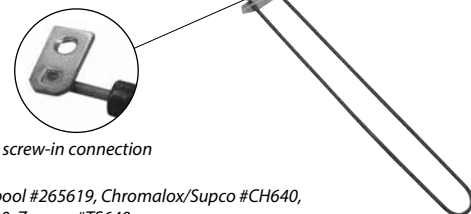

Also fits: Whirlpool #265619, Chromalox/Supco #CH640, Gemline #RP640, Zoppas #TS640

## Order No. ERB641

Watts: 3000/2250 Volts: 240/208

- A = 1-1/2"
- B = 1-1/8"
- C = 16"
- D = 19-1/2"

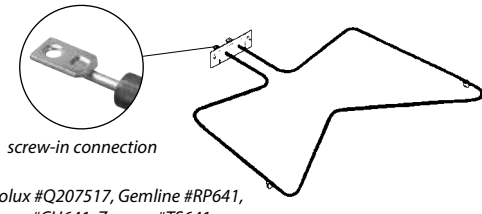

Also fits: Electrolux #Q207517, Gemline #RP641, Chromalox/Supco #CH641, Zoppas #TS641

COOKING

# BAKE AND BROIL ELEMENTS

Engineered to OEM specifications, ERP utilizes world-class manufacturers for Bake & Broil elements.

## Measurement Key for Elements

- A = Measurement between terminals
- B = Measurement between terminal end and mounting bracket
- C = Measurement between mounting bracket and end of element
- D = Measurement of element width
- E = Measurement between indentation of element and end of element

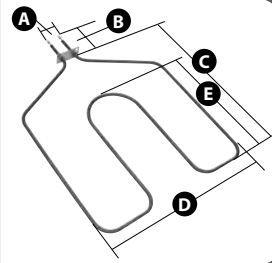

## Order No. ERB651

Watts: 2700 Volts: 240

- A = 9-3/4"
- B = 1-5/8"
- C = 14-3/4"
- D = 14-1/2"

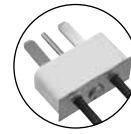

push-in pin connection

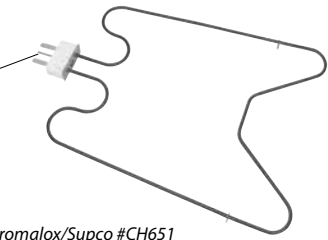

Also fits: Electrolux #5300210961, Chromalox/Supco #CH651

## Order No. ERB672

Watts: 2400 Volts: 250

- A = 16"
- B = 1-1/2"
- C = 16-1/2"
- D = 16"
- E = 2-1/2"

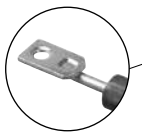

screw-in connection

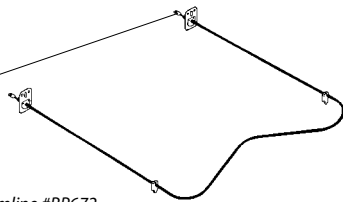

Also fits: Whirlpool #12500109, Gemline #RP672, Chromalox/Supco #CH672, Monarch #R01-08041, Zoppas #TS672

## Order No. ERB680

Watts: 2600/1950 Volts: 240/208

- A = 1-3/4"
- B = 2-1/2"
- C = 17"
- D = 19-7/8"



.250" male terminal push-in connection

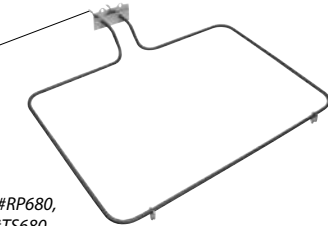

Also fits: Brown #184-2E36, Gemline #RP680, Chromalox/Supco #CH680, Zoppas #TS680

## Order No. ERB681

Watts: 2300/1725 Volts: 240/208

- A = 1-3/4"
- B = 2"
- C = 16-1/4"
- D = 10"

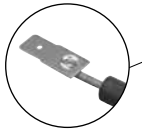

.250" male terminal push-in connection

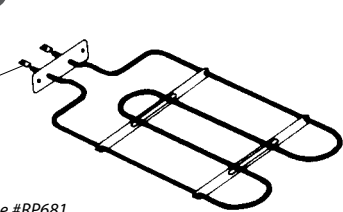

Also fits: Brown #184-2E34, Gemline #RP681, Chromalox/Supco #CH681, Zoppas #TS681

## Order No. ERB700

Watts: 2500 Volts: 250

- A = 21-5/16"
- B = 2-3/4"
- C = 16-1/4"
- D = 21-1/8"
- E = 2"



.250" male terminal push-in connection

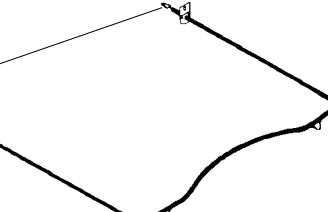

Also fits: Whirlpool #4328956, Chromalox/Supco #CH700, Gemline #RP700, Zoppas #TS700

## Order No. ERB701

Watts: 2750/2065 Volts: 240/208

- A = 16"
- B = 1-3/4"
- C = 16-1/2"
- D = 16"



screw-in connection

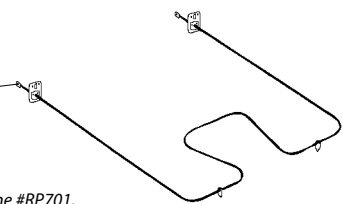

Also fits: Chambers #7568E, Gemline #RP701, Chromalox/Supco #CH1004, Zoppas #TS701

## Order No. ERB716

Watts: 3000/2250 Volts: 240/208

- A = 1-1/4"
- B = 2-1/2"
- C = 16"
- D = 18"

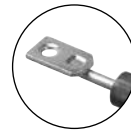

screw-in connection

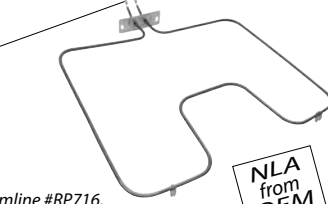

Also fits: Electrolux #5300207513, Gemline #RP716, Chromalox/Supco #CH2864, Zoppas #TS716

NLA from OEM

## Order No. ERB775

Watts: 2400/1800 Volts: 240/208

- A = 13"
- B = 3-3/4"
- C = 15"
- D = 19-1/4"



90 degree .250" male terminal push-in connection

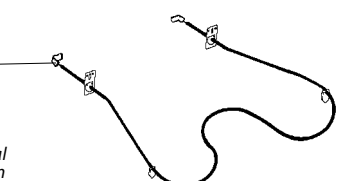

Also fits: Whirlpool #865940, Electrolux #5303051519, GE #WB44X5089, Gemline #RP775, Chromalox/Supco #CH775, Zoppas #TS775

## Order No. ERB776

Watts: 2500/1875 Volts: 240/208

- A = 19"
- B = 3-1/2"
- C = 15-1/4"
- D = 19"

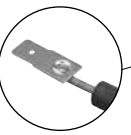

.250" male terminal push-in connection

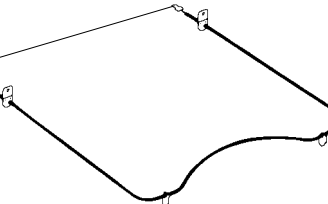

Also fits: Whirlpool #4334146, Chromalox/Supco #CH776, Gemline #RP776, Zoppas #TS776

# BAKE AND BROIL ELEMENTS

Engineered to OEM specifications, ERP utilizes world-class manufacturers for Bake & Broil elements.

## Order No. ERB777

Watts: 2750/2065 Volts: 240/208

- A = 1-3/4"
- B = 3-1/4"
- C = 14-3/4"
- D = 19-3/4"

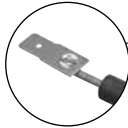

.250" male terminal push-in connection



Also fits: Whirlpool #4328405, #301444, Chromalox/Supco #CH2858, Gemline #RP777, Zoppas #TS777

## Order No. ERB778

Watts: 2100/1577 Volts: 240/208

- A = 12-1/8"
- B = 3"
- C = 15"
- D = 15-3/4"
- E = 2-3/8"



90 degree .250" male terminal push-in connection

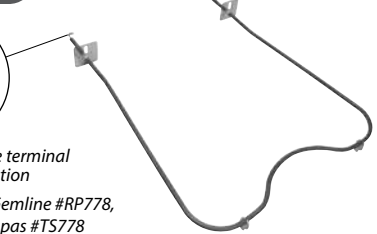

Also fits: Whirlpool #4336509, Gemline #RP778, Chromalox/Supco #CH687, Zoppas #TS778

## Order No. ERB779

Watts: 3000/2250 Volts: 240/208

- A = 11-3/4"
- C = 18-1/2"
- D = 11-3/4"
- E = 14"



.250" male terminal push-in connection

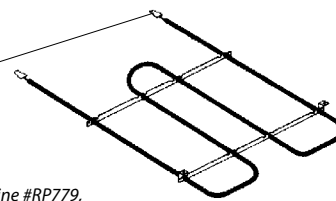

Also fits: Whirlpool #312308, Gemline #RP779, Chromalox/Supco #CH779, Zoppas #TS779

## Order No. ERB790

Watts: 2600/1950 Volts: 240/208

- A = 1-3/4"
- B = 3"
- C = 15-3/4"
- D = 16-5/8"

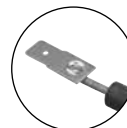

.250" male terminal push-in connection

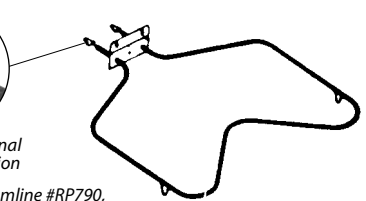

Also fits: Whirlpool #308180, Gemline #RP790, Chromalox/Supco #CH4836, Whirlpool #Y0410020, Zoppas #TS790

## Order No. ERB798

Watts: 2600/1950 Volts: 240/208

- A = 1-3/4"
- B = 2-3/4"
- C = 14-3/4"
- D = 18-3/4"



90 degree .250" male terminal push-in connection

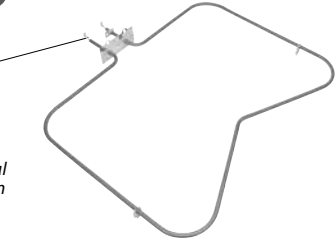

Also fits: Whirlpool #Y0400041, Chromalox/Supco #CH5830,

## Order No. ERB825

Watts: 2000 Volts: 240

- A = 1"
- B = 1"
- C = 11-7/8"
- D = 14-3/16"



screw-in connection

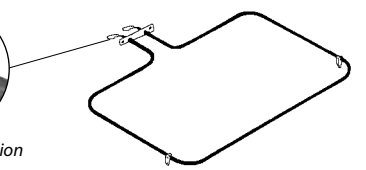

Also fits: Whirlpool #7406166, Gemline #RP825, Chromalox/Supco #CH825, Zoppas #TS825

## Order No. ERB829

Watts: 3000 Volts: 240

- A = 13-1/4"
- B = 3-1/2"
- C = 15-7/8"
- D = 13-1/4"



.250" male terminal push-in connection

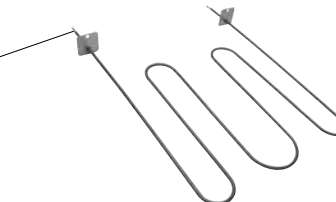

Also fits: Electrolux #5303051516, Chromalox/Supco #CH4874, Gemline #RP829, Zoppas #TS829

## Order No. ERB835

Watts: 3400/2550 Volts: 240/208

- A = 13-1/2"
- B = 3"
- C = 15-1/2"
- D = 13-1/2"



.250" male terminal push-in connection

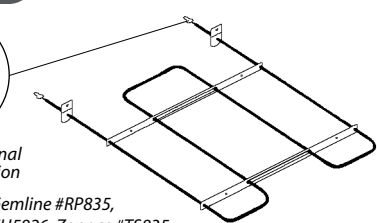

Also fits: Whirlpool #4335542, Gemline #RP835, Chromalox/Supco #CH4847, #CH5826, Zoppas #TS835

## Order No. ERB837

Watts: 2400/1800 Volts: 240/208

- A = 13"
- B = 3"
- C = 15-1/4"
- D = 19-1/2"
- E = 7-1/4"



90 degree .250" male terminal push-in connection

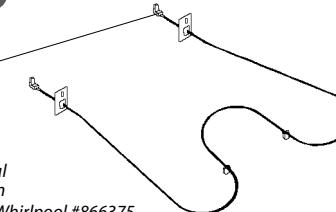

Also fits: Electrolux #5308003347, Whirlpool #866375, Chromalox/Supco #CH4879, Gemline #RP837, Zoppas #TS837

## Order No. ERB838

Watts: 2000/1500 Volts: 240/208

- A = 17-1/2"
- B = 1-3/4"
- C = 16-1/4"
- D = 17-1/2"



.250" male terminal push-in connection

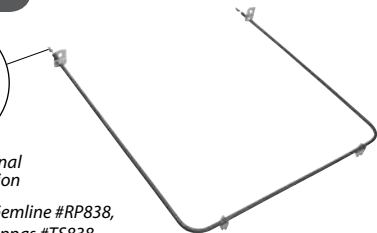

Also fits: Whirlpool #4333167, Gemline #RP838, Chromalox/Supco #CH4854, Zoppas #TS838

COOKING



# BAKE AND BROIL ELEMENTS

Engineered to OEM specifications, ERP utilizes world-class manufacturers for Bake & Broil elements.

## Measurement Key for Elements

- A = Measurement between terminals
- B = Measurement between terminal end and mounting bracket
- C = Measurement between mounting bracket and end of element
- D = Measurement of element width
- E = Measurement between indentation of element and end of element

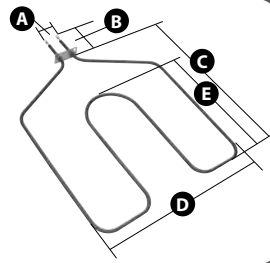

## Order No. ERB839

Watts: 2600/1950 Volts: 240/208

- A = 18-1/2"
- B = 3"
- C = 16"
- D = 20-1/4"
- E = 2-7/8"

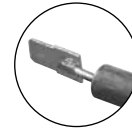

.250" male terminal push-in connection

Also fits: Whirlpool #832513, Gemline #RP839, Chromalox/Supco #CH4893, Zoppas #TS839

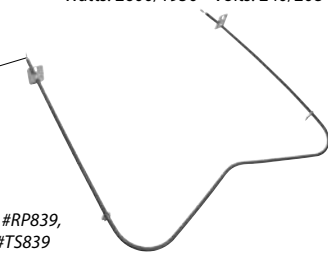

## Order No. ERB841

Watts: 2500/1880 Volts: 240/208

- A = 22"
- B = 3-3/8"
- C = 15"
- D = 22"
- E = 3-1/4"



.250" male terminal push-in connection

Also fits: Whirlpool #326793, Gemline #RP841, Chromalox/Supco #CH2860, Zoppas #TS841

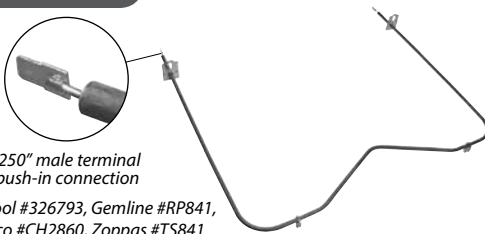

## Order No. ERB842

Watts: 2000 Volts: 240

- A = 1-3/4"
- B = 3-1/4"
- C = 17-1/4"
- D = 12-1/2"



90 degree .250" male terminal push-in connection

Also fits: Electrolux #5303051076, Whirlpool #456948, Chromalox/Supco #CH5818, Gemline #RP842

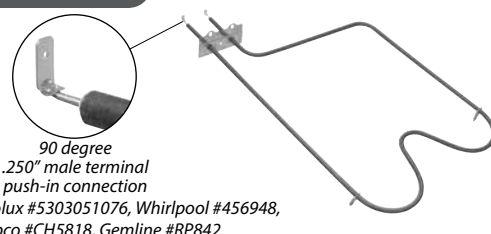

## Order No. ERB853

Watts: 2000 Volts: 240

- A = 1-3/4"
- B = 2-3/8"
- C = 15-3/4"
- D = 13-1/4"



.250" male terminal push-in connection

Also fits: Brown #1842E37, Electrolux #5303285965, Chromalox/Supco #CH679, Gemline #RP853, Zoppas #TS853

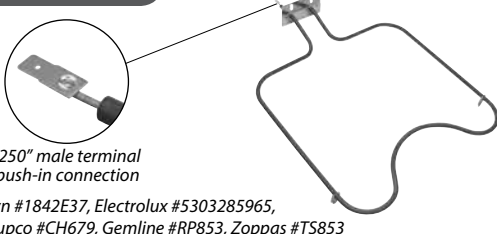

## Order No. ERB855

Watts: 2600 Volts: 240

- A = 20-7/8"
- B = 1-7/8"
- C = 14-9/16"
- D = 21"



screw-in connection

Also fits: Whirlpool #Y07409600, #4314958, Chromalox/Supco #CH4833, Gemline #RP855

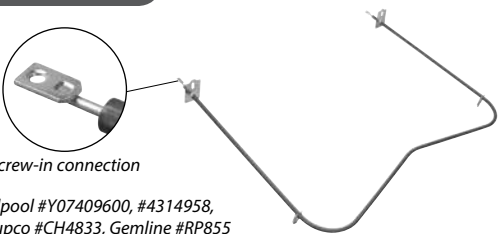

## Order No. ERB856

Watts: 2750/2065 Volts: 240/208

- A = 1-3/4"
- B = 2"
- C = 16"
- D = 16"



90 degree .250" male terminal push-in connection

Also fits: Whirlpool #Y04000066, Gemline #RP856, Chromalox/Supco #CH5829, Zoppas #TS856

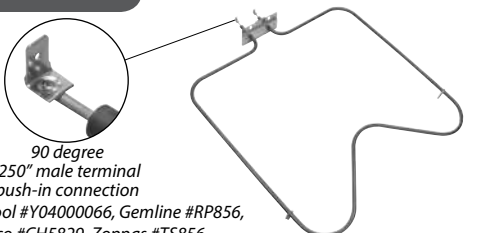

## Order No. ERB858

Watts: 3400 Volts: 240

- A = 13-1/4"
- B = 3-7/8"
- C = 14-7/8"
- D = 13-1/4"



.250" male terminal push-in connection

Also fits: Whirlpool #4334925, Chromalox/Supco #CH5855, Gemline #RP858

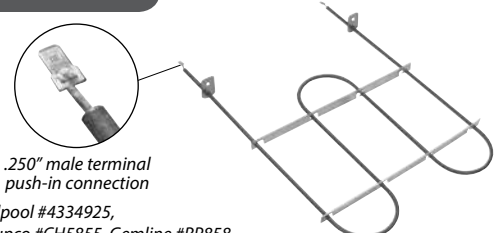

## Order No. ERB871

Watts: 2500 Volts: 240

- A = 3-1/2"
- B = 4"
- C = 15-3/4"
- D = 19-1/4"

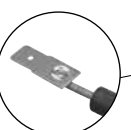

.250" male terminal push-in connection

Also fits: Whirlpool #4334928, Gemline #RP871, Chromalox/Supco #CH5853, Zoppas #TS871

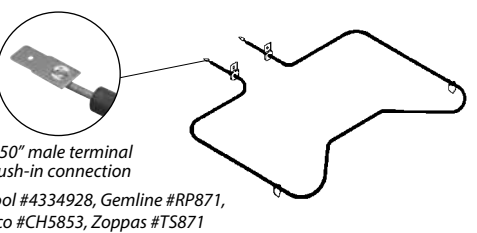

## Order No. ERB978

Watts: 3000/2330 Volts: 236/208

- A = 1-1/4"
- B = 1-3/8"
- C = 12-3/4"
- D = 18-3/4"
- E = 5-1/4"

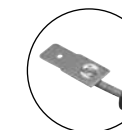

.250" male terminal push-in connection

Also fits: Electrolux #5309950885, Gemline #RP978, Chromalox/Supco #CH978, Zoppas #TS978

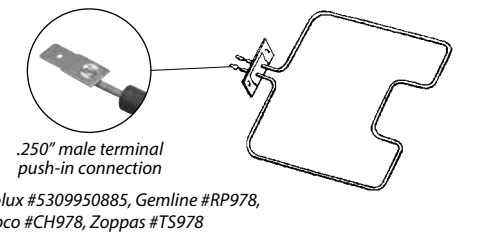

# BAKE AND BROIL ELEMENTS

Engineered to OEM specifications, ERP utilizes world-class manufacturers for Bake & Broil elements.

## Order No. ERB979

Watts: 2700 Volts: 250

- A = 1-1/4"
- B = 1"
- C = 19"
- D = 13-1/4"
- E = 6-1/8"



.250" male terminal push-in connection

Also fits: Electrolux #5309950887, Gemline #RP979, Chromalox/Supco #CH979, Zoppas #TS979

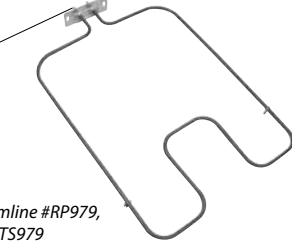

## Order No. ERB980

Watts: 3000 Volts: 250

- A = 1-3/4"
- B = 2-1/4"
- C = 14-3/8"
- D = 16"
- E = 9"



push-in pin connection

Also fits: GE #WB44X5019, Gemline #RP980, Chromalox/Supco #CH44X5019, Zoppas #TS980

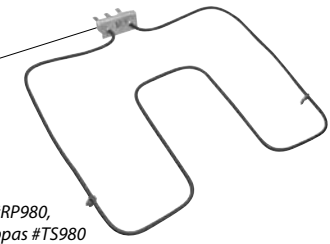

## Order No. ERB985

Watts: 3000/2250 Volts: 240/208

- A = 1-1/4"
- B = 1-3/4"
- C = 15-1/4"
- D = 11-1/4"



90 degree screw-in connection

Also fits: GE #WB44X5045, Gemline #RP985, Chromalox/Supco #CH44X5045, Zoppas #TS985

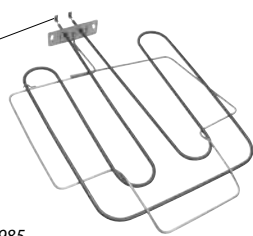

## Order No. ERB987

Watts: 3000/2250 Volts: 240/208

- A = 11-3/4"
- C = 18-1/8"
- D = 11-3/4"
- E = 13-1/8"

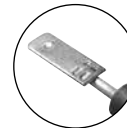

.250" male terminal push-in connection

Also fits: Whirlpool #326795, Gemline #RP987, Chromalox/Supco #CH987, Zoppas #TS987

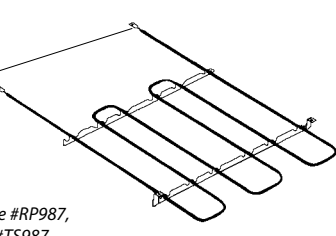

## Order No. ERB0213

Watts: 2304 Volts: 240

- A = 2"
- B = 2-1/4"
- C = 14-3/4"
- D = 19"



.250" male terminal push-in connection

Also fits: Whirlpool #9750213

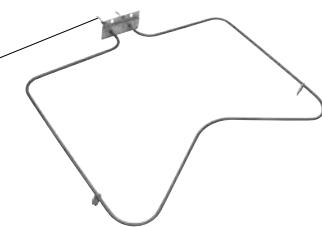

## Order No. ERB0750

Watts: 2585/1939 Volts: 240/208

- A = 19"
- B = 3-1/4"
- C = 15-1/4"
- D = 19"
- E = 6-3/8"

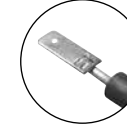

.250" male terminal push-in connection

Also fits: Whirlpool #74010750

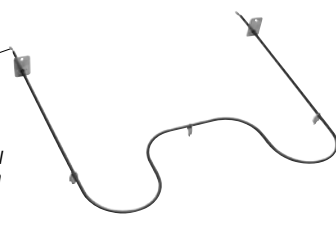

## Order No. ERB0766

Watts: 2000 Volts: 240

- A = 1-3/4"
- B = 1-1/2"
- C = 15-1/8"
- D = 14-3/4"
- E = 6-1/2"

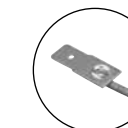

.250" male terminal push-in connection

**NEW!**

Also fits: Whirlpool #9760766

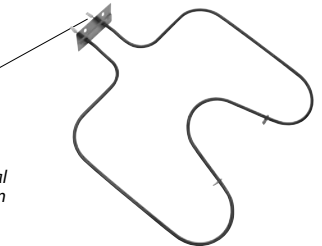

## Order No. ERB1094

Watts: 2500 Volts: 240

- A = 2"
- B = 3"
- C = 13-3/8"
- D = 15-1/8"

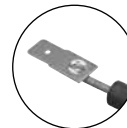

.250" male terminal push-in connection

Also fits: Whirlpool #77001094

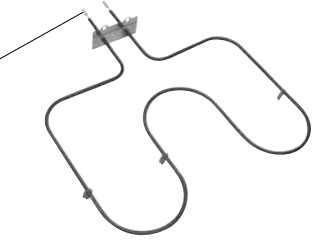

## Order No. ERB1117

Watts: 3600 Volts: 240

- A = 2"
- B = 3-5/8"
- C = 15"
- D = 18-1/4"
- E = 11"

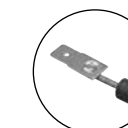

.250" male terminal push-in connection

Also fits: Whirlpool #74011117

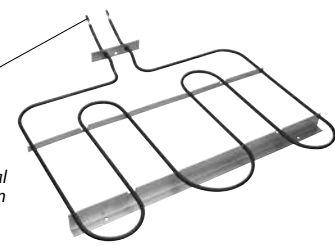

## Order No. ERB2200

Watts: 3500 Volts: 240

- A = 12-5/8"
- B = 4"
- C = 15-3/4"
- D = 17-3/8"



.250" male terminal push-in connection

Also fits: Electrolux #316202200

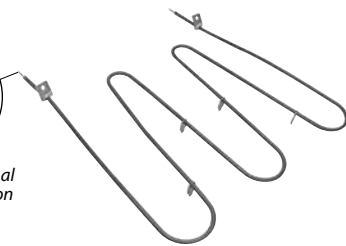

COOKING

# BAKE AND BROIL ELEMENTS

Engineered to OEM specifications, ERP utilizes world-class manufacturers for Bake & Broil elements.

## Measurement Key for Elements

- A = Measurement between terminals
- B = Measurement between terminal end and mounting bracket
- C = Measurement between mounting bracket and end of element
- D = Measurement of element width
- E = Measurement between indentation of element and end of element

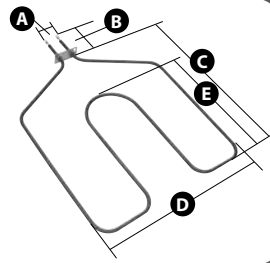

## Order No. ERB2395

Watts: 2000 Volts: 250

- A = 13-1/2"
- B = 2-3/8"
- C = 14-7/8"
- D = 13-1/2"

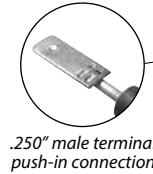

.250" male terminal push-in connection

Also fits: Peerless Premier #2395

## Order No. ERB2396

Watts: 2800 Volts: 250

- A = 9-3/4"
- B = 2-3/8"
- C = 15"
- D = 9-3/4"



.250" male terminal push-in connection

Also fits: Peerless Premier #2396

## Order No. ERB3020

Watts: 2800/2100 Volts: 240/208

- A = 18-3/4"
- B = 3-1/4"
- C = 15-1/2"
- D = 18-3/4"
- E = 6-5/8"



.250" female flag terminal connection

Also fits: Whirlpool #74003020

## Order No. ERB3200

Watts: 3000 Volts: 240

- A = 11-3/4"
- B = 3-1/4"
- C = 15-3/8"
- D = 11-3/4"

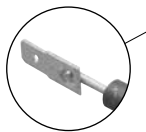

.250" male terminal push-in connection

Also fits: Electrolux #316203200

## Order No. ERB3301

Watts: 4000 Volts: 240

- A = 12-3/8"
- B = 3-1/4"
- C = 15-3/8"
- D = 12-3/8"



.250" male terminal push-in connection

Also fits: Electrolux #316203301

## Order No. ERB3800

Watts: 3500 Volts: 240

- A = 14"
- B = 3"
- C = 15-3/4"
- D = 14-1/4"

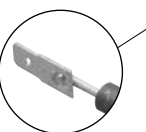

.250" male terminal push-in connection

Also fits: Electrolux #316413800

## Order No. ERB4107

Watts: 2585/1939 Volts: 240/208

- A = 2"
- B = 3-1/4"
- C = 15-3/8"
- D = 18-7/8"
- E = 6-3/8"



.250" male terminal push-in connection

Also fits: Whirlpool #74004107

## Order No. ERB4835

Watts: 1800/1350 Volts: 240/208

- A = 13-1/4"
- B = 2"
- C = 15-1/2"
- D = 13-1/4"

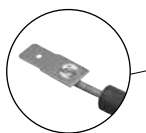

.250" male terminal push-in connection

Also fits: Whirlpool #4157977, #Y07431100, Chromalox/Supco #CH4835, Gemline #RP4835, Zoppas #TS4835

## Order No. ERB5002

Watts: 3000 Volts: 240

- A = 2-1/4"
- B = 4"
- C = 15-1/2"
- D = 20-1/8"



90 degree .250" male terminal push-in connection

Also fits: Electrolux #318255002

# BAKE AND BROIL ELEMENTS

Engineered to OEM specifications, ERP utilizes world-class manufacturers for Bake & Broil elements.

## Order No. ERB5103

Watts: 2600 Volts: 240

- A = 16-1/8"
- B = 3-3/8"
- C = 14-3/4"
- D = 19-1/4"

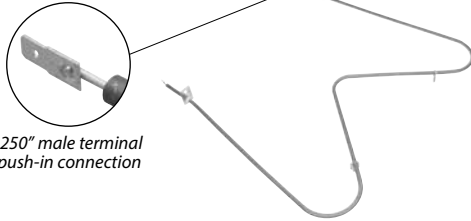

.250" male terminal push-in connection

Also fits: Electrolux #316075104

## Order No. ERB5862

Watts: 2800/2100 Volts: 240/208

- A = 18-3/4"
- B = 3-1/8"
- C = 16-1/2"
- D = 18-3/4"
- E = 7-3/8"

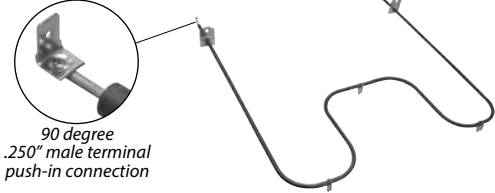

90 degree .250" male terminal push-in connection

Also fits: Whirlpool #OE00105099, Chromalox/Supco #CH5862, Gemline #5862, Zoppas #TS5862

## Order No. ERB5900

Watts: 3500 Volts: 240

- A = 13"
- B = 3-1/2"
- C = 15-7/8"
- D = 15-5/8"
- E = 12-1/4"

**NEW!**

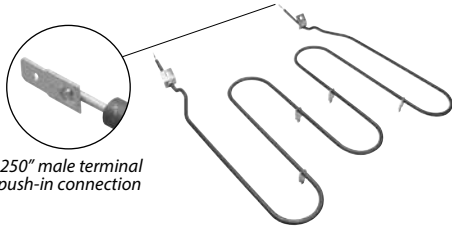

.250" male terminal push-in connection

Also fits: Electrolux #316415900

## Order No. ERB7019

Watts: 2800/2100 Volts: 240/208

- A = 19-1/2"
- B = 3-1/2"
- C = 15-1/4"
- D = 19-1/2"
- E = 6-3/4"

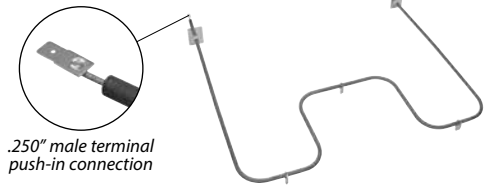

.250" male terminal push-in connection

Also fits: Gemline #RP7019, Whirlpool #74003019, Zoppas #TS7019

## Order No. ERB7340

Watts: 3400/2550 Volts: 240/208

- A = 9"
- B = 2-5/8"
- C = 16-3/4"
- D = 18-7/8"

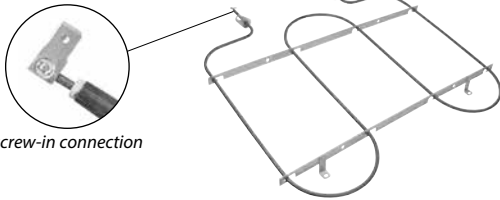

screw-in connection

Also fits: Whirlpool #9757340, #W10308476

## Order No. ERB8519

Watts: 2400 Volts: 240

- A = 2"
- B = 2-5/8"
- C = 15-1/2"
- D = 21-1/4"

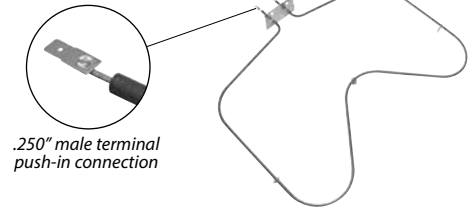

.250" male terminal push-in connection

Also fits: Whirlpool #9758519

## Order No. ERB8541

Watts: 2400/1800 Volts: 240/208

- A = 2-1/8"
- B = 2-1/2"
- C = 15-1/4"
- D = 20-3/8"
- E = 6-1/4"

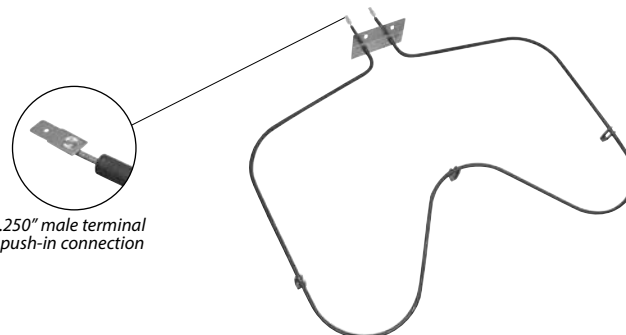

.250" male terminal push-in connection

Also fits: Whirlpool #9758541



# BAKE AND BROIL ELEMENTS

## BAKE & BROIL ELEMENT CROSS REFERENCE

OEM Part #	ERP #	PG
<b>AMANA</b> <i>See Whirlpool</i>		
<b>BROWN</b>		
184-2E34	ERB681	6
184-2E36	ERB680	6
1842E37	ERB853	8
<b>CALORIC</b> <i>See Whirlpool</i>		
<b>CHROMALOX/SUPCO</b>		
029-871854-001	ERB985	9
029-871898-001	ERB44X134	3
029-873849-001	ERB987	9
029-873891-001	ERB681	6
029-874835-001	ERB4835	10
029-874847-001	ERB835	7
029-874874-001	ERB829	7
029-875831-001	ERB44X5074	4
029-875892-001	ERB5862	11
202-871700-002	ERB580	5
202-871803-001	ERB620	5
202-871822-001	ERB980	9
202-871853-001	ERB825	7
202-871864-001	ERB701	6
202-871878-005	ERB613	5
202-871895-002	ERB978	8
202-871896-001	ERB979	9
202-872818-001	ERB44X5099	4
202-872823-001	ERB776	6
202-872826-001	ERB680	6
202-872858-001	ERB777	7
202-872879-001	ERB672	6
202-872892-001	ERB775	6
202-873803-001	ERB550	5
202-873813-002	ERB584	5
202-873857-001	ERB700	6
202-873877-001	ERB778	7
202-873885-001	ERB44X5043	4
202-874836-001	ERB790	7
202-874854-001	ERB838	7
202-874879-001	ERB837	7
202-874893-001	ERB839	8
202-875829-001	ERB856	8
202-875832-001	ERB44X5082	4

OEM Part #	ERP #	PG
202-875843-001	ERB44X200	3
202-875853-001	ERB871	8
202-875862-001	ERB5862	11
400506	ERB580	5
440065	ERB5862	11
450546	ERB44X126	3
450757	ERB613	5
450870	ERB701	6
451119	ERB980	9
451400	ERB651	6
453034	ERB550	5
453093	ERB584	5
453237	ERB641	5
453333	ERB700	6
453472	ERB987	9
453721	ERB778	7
453771	ERB825	7
453780	ERB985	9
453827	ERB680	6
453843	ERB620	5
454096	ERB44X134	3
454150	ERB978	8
454168	ERB979	9
454280	ERB44X5043	4
454563	ERB681	6
454816	ERB44X5099	4
454926	ERB777	7
455857	ERB672	6
455988	ERB775	6
456091	ERB776	6
456470	ERB855	8
456497	ERB4835	10
456500	ERB790	7
456948	ERB842	8
457545	ERB835	7
457908	ERB829	7
458003	ERB837	7
458150	ERB856	8
458169	ERB798	7
458185	ERB44X5074	4
458193	ERB44X5082	4

OEM Part #	ERP #	PG
458290	ERB44X200	3
458521	ERB871	8
458548	ERB858	8
458580	ERB5862	11
CH44K5012	ERB44K5012	2
CH44X126	ERB44X126	3
CH44X127	ERB44X127	3
CH44X134	ERB44X134	3
CH44X173	ERB44X173	3
CH44X195	ERB44X195	3
CH44X200	ERB44X200	3
CH44X5019	ERB980	9
CH44X5043	ERB44X5043	4
CH44X5045	ERB985	9
CH44X5074	ERB44X5074	4
CH44X5082	ERB44X5082	4
CH44X5099	ERB44X5099	4
CH550	ERB550	5
CH584	ERB584	5
CH613	ERB613	5
CH620	ERB620	5
CH640	ERB640	5
CH641	ERB641	5
CH651	ERB651	6
CH672	ERB672	6
CH680	ERB680	6
CH681	ERB681	6
CH687	ERB778	7
CH700	ERB700	6
CH775	ERB775	6
CH776	ERB776	6
CH779	ERB779	7
CH825	ERB825	7
CH978	ERB978	8
CH979	ERB979	9
CH987	ERB987	9
CH1004	ERB701	6
CH2858	ERB777	7
CH2860	ERB841	8
CH2864	ERB716	6
CH2865	ERB837	7

OEM Part #	ERP #	PG
CH4833	ERB855	8
CH4835	ERB4835	10
CH4836	ERB790	7
CH4847	ERB835	7
CH4854	ERB838	7
CH4874	ERB829	7
CH4879	ERB837	7
CH4893	ERB839	8
CH5818	ERB842	8
CH5826	ERB835	7
CH5829	ERB856	8
CH5830	ERB798	7
CH5853	ERB871	8
CH5855	ERB858	8
CH5856	ERB858	8
CH5862	ERB5862	11
ROU-N	ERB580	5
<b>EAGLE</b>		
56993	ERB700	6
<b>ELECTROLUX</b>		
221T004P09	ERB613	5
221T017P01*	ERB584	5
316075104	ERB5103	11
316202200	ERB2200	9
316203200	ERB3200	10
316203301	ERB3301	10
316413800	ERB3800	10
316415900	ERB5900	11
318255002	ERB5002	10
5300207513*	ERB716	6
5300207517	ERB641	5
5300210961	ERB651	6
5303051076*	ERB842	8
5303051516	ERB829	7
5303051519	ERB775	6
5303285965	ERB853	8
5308003347	ERB837	7
5309950885	ERB978	8
5309950887	ERB979	9
G41035	ERB620	5
G39542	ERB620	5

\* Bake or broil element is NLA from OEM - still available at ERP

For up-to-date cross reference, go to [www.erparts.com](http://www.erparts.com)

# BAKE AND BROIL ELEMENTS

## BAKE & BROIL ELEMENT CROSS REFERENCE

OEM Part #	ERP #	PG
Q207217	ERB641	5
<b>GE/HOTPOINT</b>		
WB44K1002	ERB44K1002	2
WB44K1005	ERB44K1005	2
WB44K10019	ERB44K10019	2
WB44K5009	ERB44K5009	2
WB44K5012	ERB44K5012	2
WB44K5013	ERB44K5013	2
WB44T10009	ERB44T10009	2
WB44T10010	ERB44T10010	2
WB44T10011	ERB44T10011	2
WB44T10014	ERB44T10014	3
WB44T10017	ERB44T10017	3
WB44T10018	ERB44T10018	3
WB44X10009	ERB44X10009	4
WB44X10013	ERB44X10013	4
WB44X10015	ERB44X10015	4
WB44X10016	ERB44X10016	5
WB44X10027	ERB44X10027	5
WB44X10028	ERB44X10028	5
WB44X126	ERB44X126	3
WB44X127	ERB44X127	3
WB44X134	ERB44X134	3
WB44X139	ERB44X139	3
WB44X173	ERB44X173	3
WB44X195	ERB44X195	3
WB44X196	ERB44X127	3
WB44X200	ERB44X200	3
WB44X228	ERB44X228	4
WB44X232	ERB44X232	4
WB44X238	ERB778	7
WB44X5019	ERB980	9
WB44X5043	ERB44X5043	4
WB44X5045	ERB985	9
WB44X5074	ERB44X5074	4
WB44X5082	ERB44X5082	4
WB44X5089	ERB775	6
WB44X5099	ERB44X5099	4
<b>GEMLINE</b>		
RP44X127	ERB44X127	3
RP44X134	ERB44X134	3

OEM Part #	ERP #	PG
RP44X173	ERB44X173	3
RP44X195	ERB44X195	3
RP44X200	ERB44X200	3
RP44X228	ERB44X228	4
RP44X5043	ERB44X5043	4
RP44X5074	ERB44X5074	4
RP44X5082	ERB44X5082	4
RP44X5099	ERB44X5099	4
RP550	ERB550	5
RP580	ERB580	5
RP584	ERB584	5
RP613	ERB613	5
RP620	ERB620	5
RP640	ERB640	5
RP641	ERB641	5
RP651	ERB651	6
RP672	ERB672	6
RP680	ERB680	6
RP681	ERB681	6
RP700	ERB700	6
RP701	ERB701	6
RP716	ERB716	6
RP775	ERB775	6
RP776	ERB776	6
RP777	ERB777	7
RP778	ERB778	7
RP779	ERB779	7
RP790	ERB790	7
RP798	ERB798	7
RP825	ERB825	7
RP829	ERB829	7
RP835	ERB835	7
RP837	ERB837	7
RP838	ERB838	7
RP839	ERB839	8
RP841	ERB841	8
RP842	ERB842	8
RP858	ERB858	8
RP871	ERB871	8
RP978	ERB978	8
RP979	ERB979	9

OEM Part #	ERP #	PG
RP980	ERB980	9
RP985	ERB985	9
RP987	ERB987	9
<b>GIBSON See Electrolux</b>		
<b>GLENWOOD See Whirlpool</b>		
<b>HARDWICK See Whirlpool</b>		
<b>JENN-AIR See Whirlpool</b>		
<b>KELVINATOR See Whirlpool</b>		
<b>KENMORE See Whirlpool</b>		
<b>MAGIC CHEF See Whirlpool</b>		
<b>MAYTAG See Whirlpool</b>		
<b>MODERN MAID See Whirlpool</b>		
<b>NORGE See Whirlpool</b>		
<b>PEERLESS PREMIER</b>		
2395	ERB2395	10
2396	ERB2396	10
<b>ROPER See Whirlpool</b>		
<b>STILLMAN See Zoppas</b>		
<b>SUNRAY See Whirlpool</b>		
<b>TAPPAN See Electrolux</b>		
<b>THERMADOR</b>		
14-09-956	ERB580	5
<b>WESTINGHOUSE See Electrolux</b>		
<b>WHIRLPOOL</b>		
0045545*	ERB620	5
0050279*	ERB550	5
0089673*	ERB775	6
03002	ERB620	5
0E00104899*	ERB776	6
0E00105099*	ERB5862	11
12500109*	ERB672	6
201767*	ERB790	7
202550*	ERB790	7
277543*	ERB700	6
282717*	ERB776	6
293146*	ERB835	7
299427*	ERB835	7
299490*	ERB835	7
301444*	ERB777	7
301471*	ERB776	6
302248*	ERB700	6

OEM Part #	ERP #	PG
302449*	ERB838	7
304977*	ERB838	7
306138*	ERB775	6
308180	ERB790	7
312308	ERB779	7
314620*	ERB776	6
319526*	ERB835	7
319529*	ERB776	6
319837*	ERB776	6
320415*	ERB838	7
320421*	ERB776	6
324187*	ERB776	6
325883*	ERB871	8
326360*	ERB858	8
326361*	ERB858	8
326362*	ERB858	8
326363*	ERB858	8
326364*	ERB871	8
326365*	ERB871	8
326366*	ERB871	8
326791	ERB778	7
326793	ERB841	8
326795	ERB987	9
326938*	ERB858	8
326939*	ERB858	8
327042*	ERB838	7
328115*	ERB835	7
340521*	ERB44K5012	2
340521*	ERB871	8
340635*	ERB44X139	3
344894*	ERB44K5013	2
41-4601*	ERB835	7
4157977	ERB4835	10
4314958	ERB855	8
4328405	ERB777	7
4328956*	ERB700	6
4332897*	ERB835	7
4333167	ERB838	7
4334146	ERB776	6
4334925	ERB858	8
4334927*	ERB871	8

\* Bake or broil element is NLA from OEM - still available at ERP

For up-to-date cross reference, go to [www.erparts.com](http://www.erparts.com)

All logos, trademarks, part numbers, photos & illustrations are intended solely for identification. Items offered for sale are not represented to be manufactured by the company that built the original equipment.

# BAKE AND BROIL ELEMENTS

## BAKE & BROIL ELEMENT CROSS REFERENCE

OEM Part #	ERP #	PG
4334928	ERB871	8
4334929*	ERB871	8
4335542*	ERB835	7
4336509	ERB778	7
45-1259*	ERB620	5
45-1932*	ERB550	5
45-2035*	ERB700	6
456948	ERB842	8
660579	ERB779	7
71001680	ERB790	7
74003019	ERB7019	11
74003020	ERB3020	10
74003039	ERB5862	11
74004107	ERB4107	10
74010750	ERB0750	9
74011117	ERB1117	9
7406166*	ERB825	7
74-6-121*	ERB550	5
74-6-148*	ERB825	7
74-6-166*	ERB825	7
74-6-208*	ERB825	7
77001092	ERB837	7
77001094	ERB1094	9

OEM Part #	ERP #	PG
814431	ERB7340	11
832513*	ERB839	8
834679	ERB837	7
865638	ERB829	7
865940	ERB775	6
866375	ERB837	7
9750213	ERB0213	9
9757340	ERB7340	11
9758519	ERB8519	11
9758541	ERB8541	11
9760766	ERB0766	9
K1168623	ERB620	5
Y0091381*	ERB672	6
Y04000041	ERB798	7
Y04000066	ERB856	8
Y04100019	ERB790	7
Y04100020	ERB790	7
Y07409600	ERB855	8
Y07431100	ERB4835	10
Y07565600	ERB620	5
<b>ZOPPAS</b>		
TS44K5012	ERB44K5012	2
TS44X126	ERB44X126	3

OEM Part #	ERP #	PG
TS44X127	ERB44X127	3
TS44X134	ERB44X134	3
TS44X173	ERB44X173	3
TS44X195	ERB44X195	3
TS44X200	ERB44X200	3
TS44X228	ERB44X228	4
TS44X5043	ERB44X5043	4
TS44X5074GWB	ERB44X5074	4
TS44X5082	ERB44X5082	4
TS44X5099	ERB44X5099	4
TS550	ERB550	5
TS580	ERB580	5
TS584	ERB584	5
TS613	ERB613	5
TS620	ERB620	5
TS640	ERB640	5
TS641	ERB641	5
TS672	ERB672	6
TS680	ERB680	6
TS681	ERB681	6
TS700	ERB700	6
TS701	ERB701	6
TS716	ERB716	6

OEM Part #	ERP #	PG
TS775	ERB775	6
TS776	ERB776	6
TS777	ERB777	7
TS778	ERB778	7
TS779	ERB779	7
TS790	ERB790	7
TS825	ERB825	7
TS829	ERB829	7
TS835	ERB835	7
TS837	ERB837	7
TS838	ERB838	7
TS839	ERB839	8
TS841	ERB841	8
TS856	ERB856	8
TS871	ERB871	8
TS978	ERB978	8
TS979	ERB979	9
TS980	ERB980	9
TS985	ERB985	9
TS987	ERB987	9
TS4835	ERB4835	10
TS5862	ERB5862	11
TS7019	ERB7019	11

\* Bake or broil element is NLA from OEM - still available at ERP

For up-to-date cross reference, go to [www.erparts.com](http://www.erparts.com)

# ELECTRIC OVEN THERMOSTATS

Order No. ER6700S0001

Without knob

Order No. ER6700S0011

With knob

240V, 17 amps  
6 terminals  
Will replace most single or double pole thermostats

Single terminal connections: L1, L2 & PL  
Double terminal connections: BKE1 and BRL2  
Triple terminal connection: COM3

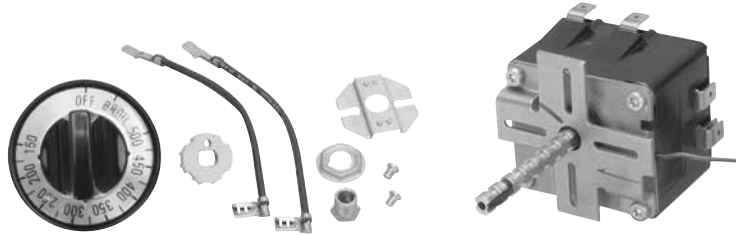

## Wiring Diagrams

Replaces most Double Pole thermostats (both L1 and L2 are switched legs) with 6 terminals: L1, L2, COM3, BKE, BRL and PL

Replaces most Single Pole thermostats (only switched leg is L1) with 4 terminals: L1, BKE, BRL and PL

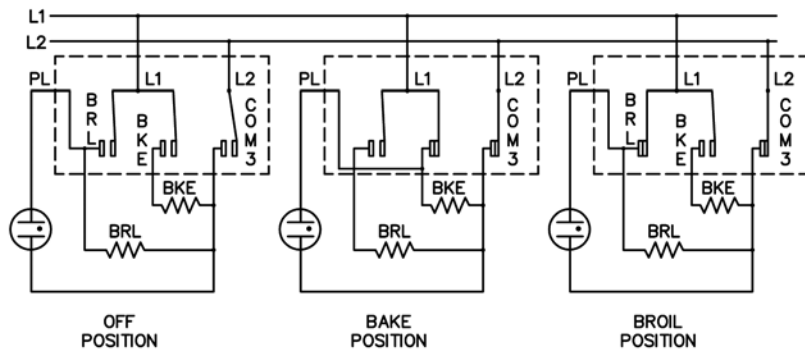

Order No. ER1842A18

240V, 17 amp  
4 terminals  
Single pole with variable broil  
36" capillary

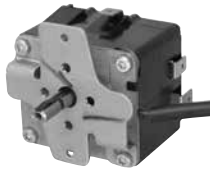

Replaces:  
Brown #1842A34, #1842A38  
Harper Wyman #6703G0007

Order No. ER1842A54

240V, 17 amp  
6 terminals  
Double pole with variable broil  
49" capillary



Replaces:  
Brown #1842A54  
Harper Wyman #6713G0021

Order No. ER1842A57

250V, 22 amp  
7 terminals  
Kit includes OEM  
oven knob



Replaces:  
Brown #1842A57

Order No. ER1842A59

250V, 22 amp  
7 terminals



Replaces:  
Brown #1842A59

Order No. ER316028600

250V, 22 amp  
7 terminals

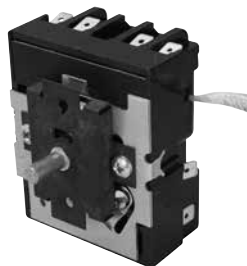

Replaces:  
Electrolux #316028600

Order No. ER316114600

250V, 22 amp  
7 terminals



Replaces:  
Electrolux #316114600

COOKING



# ELECTRIC OVEN THERMOSTATS

## Order No. ER316215901

250V, 25 amp  
7 terminals



Replaces:  
Electrolux #316215901

## Order No. ER5304457303

250V, 60 Hz, 22 amp  
7 terminals  
Kit includes  
oven knob

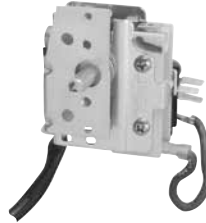

Replaces:  
Electrolux #5304457303

## Order No. ERWB20K5018

240V, 17 amp  
4 terminals  
Single pole with fixed broil  
39" capillary

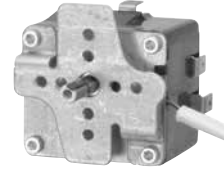

Replaces:  
GE #WB20K5018  
Harper Wyman #6707G0010

## Order No. ERWB20K5027

250 V, 25 amp  
5 terminals

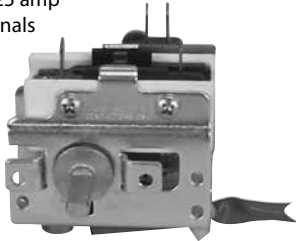

Replaces:  
GE #WB20K5027

## Order No. ERWB20K5031

240V, 20 amp  
5 terminals

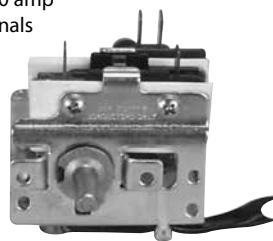

Replaces:  
GE #WB20K5031

## Order No. ERWB20K10004

240V, 30 amp  
6 terminals

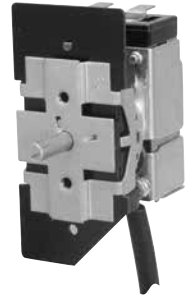

Replaces:  
GE #WB20K10004

## Order No. ERWB20K10010

240 V, 20 amp  
6 terminals

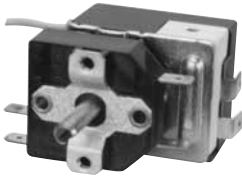

Replaces:  
GE #WB20K10010

## Order No. ERWB20K10026

240 V, 20 amp  
6 terminals

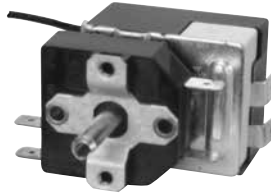

Replaces:  
GE #WB20K10026

## Order No. ERWB20X5071

240V, 30 amp  
6 terminals

**NEW!**



Replaces:  
GE #WB20X5071

## Order No. ERWB21X489

240V, 17 amp  
4 terminals  
Single pole with fixed broil  
50" capillary

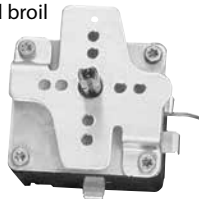

Replaces:  
GE #WB21X489  
Harper Wyman #6707G0008  
Whirlpool #334897, #4337360

## Order No. ERWB21X5287

250V, 25 amp  
5 terminals

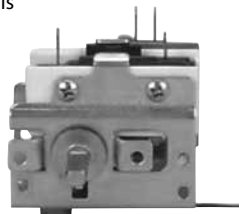

Replaces:  
GE #WB21X5287

## Order No. ERWB21X10092

400V, 16 amp  
2 terminals  
Has nickel bulb



Replaces:  
GE #WB21X10092

# ELECTRIC OVEN THERMOSTATS

## Order No. ERWB21X10098

240V, 14 amp  
2 terminals

**NEW!**



Replaces:  
GE #WB21X10098

## Order No. ERWB24X5252

240V, 17 amp  
6 terminals  
Double pole with  
variable broil  
50" capillary

NLA  
from  
OEM



Replaces:  
Brown #1842A45  
GE #WB24X5252  
Harper Wyman #6713G0018

## Order No. ERWB24X5285

240V, 17 amp  
4 terminals  
Single pole with fixed broil  
35" capillary

NLA  
from  
OEM



Replaces:  
Brown #1842A49  
GE #WB24X5285  
Harper Wyman #6707G0011

## Order No. ER2167

240V, 17 amp  
4 terminals  
Single pole with variable broil  
36" capillary



Replaces:  
Harper Wyman  
#6703G0015  
Peerless #2167  
Whirlpool #4364181

## Order No. ER2168

240V, 17 amp  
6 terminals  
Double pole with variable broil  
50" capillary



Replaces:  
Harper Wyman  
#6713G0020  
Peerless #2168  
Whirlpool #8190613

## Order No. ER3196803

240V, 25 amp  
3 terminals  
Double pole

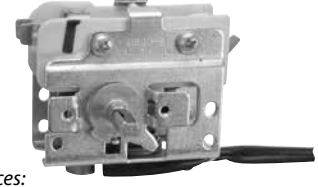

Replaces:  
Whirlpool #3196803

## Order No. ER74005019

240V, 27 amp  
8 terminals  
Double pole

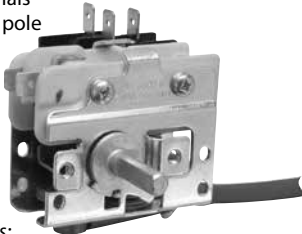

Replaces:  
Whirlpool #74003409

## Order No. ER993-475

240V, 17 amp  
5 terminals  
Double pole with variable broil  
Special CCW rotation to increase temp  
48" capillary

NLA  
from  
OEM



Replaces:  
Harper Wyman  
#6725G0005  
Whirlpool #993-475

## Order No. ERW10159016

120V, 5 amp  
2 terminals

**NEW!**



Replaces:  
Harper Wyman #6460G0024  
Whirlpool #W10159016

## Order No. ERY00206900

240V, 17 amp  
4 terminals  
Single pole with variable broil  
and automatic preheat  
30" capillary



Replaces:  
Harper Wyman #6704G0013  
Whirlpool #4157565, #Y00206900

## Order No. ERY07648601

240V, 17 amp  
4 terminals  
Single pole with variable broil and  
automatic preheat  
60" capillary

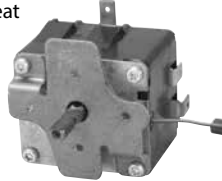

Replaces:  
Harper Wyman #6704G0030  
Whirlpool #0311775, #4320548, #Y07648601

## Order No. ER670350001

240V, 17 amp  
4 terminals  
Single pole with variable broil  
Kit includes  
OEM oven knob

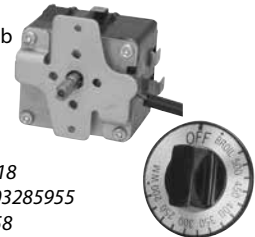

Replaces:  
Brown #1842A18  
Electrolux #5303285955  
GE #WB24X5358

COOKING

# ELECTRIC OVEN THERMOSTATS

## Order No. ER6704S0001

240V, 17 amp  
4 terminals  
Single pole with variable broil  
and automatic preheat



Replaces:  
Whirlpool #0088758, #4157565, #Y00206900

## Order No. ER6704S0002

240V, 17 amp  
4 terminals  
Single pole with variable broil and  
automatic preheat  
60" capillary

Replaces:  
Whirlpool  
#0311775  
#4320548  
#Y07648601

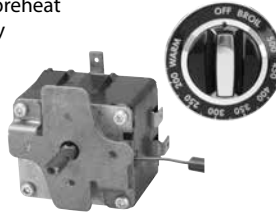

## Order No. ER6707S0001

240V, 17 amp  
4 terminals  
Single pole with fixed broil  
Includes OEM oven knob

Replaces:  
GE #WB21X489  
Whirlpool #4337360

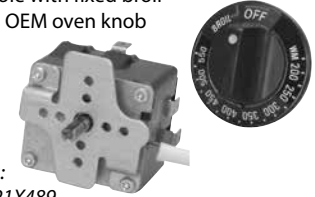

## Order No. ER6707S0002

240V, 17 amp  
4 terminals  
Single pole with fixed broil  
Includes OEM oven knob

Replaces:  
GE #WB20K5018  
Whirlpool #THS022

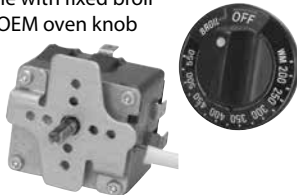

## Order No. ER6707S0003

240V, 17 amp  
4 terminals  
Single pole with fixed broil  
Includes OEM oven knob

Replaces:  
Brown #1842A49  
GE #WB24X5285

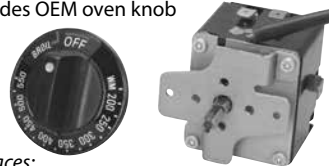

## Order No. ER6713S0001

240V, 17 amp  
6 terminals  
Double pole with variable broil  
Includes OEM oven knob

Replaces:  
Brown #1842A45  
GE #WB24X5252



## Order No. ER6713S0002

240V, 17 amp  
6 terminals  
Double pole with variable broil  
Includes OEM oven knob

Replaces:  
Peerless #2168  
Whirlpool #8190613

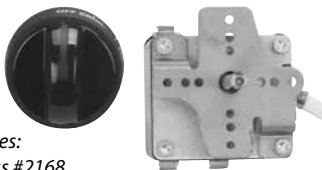

## Wiring Diagrams

Typical circuits are shown with control in the "OFF" position. These specifications apply except where noted:

- Operating temperature range: 150° to 550°F
- Ambient temperature rating: 266°F.  
(For optional 221°F rating add "70" to any one of the models listed, i.e. Model 6701 with a 221°F ambient temperature rating = Model 6771)
- Rating: 120-240 VAC (Non-inductive)  
UL: 17 amp Bake 15 amp Broil  
CSA: 15 amp Bake 15 amp Broil

### Single Pole

L2 only is a switched leg  
thru Bake terminal and  
thru Broil terminal

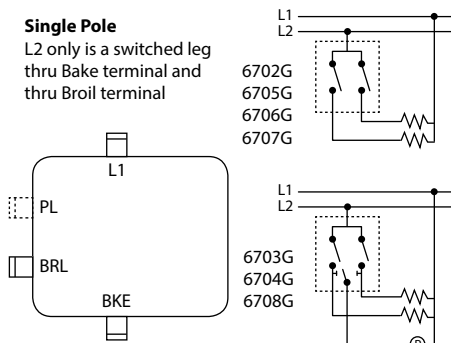

### Double Pole

Both L1 and L2 are  
switched legs

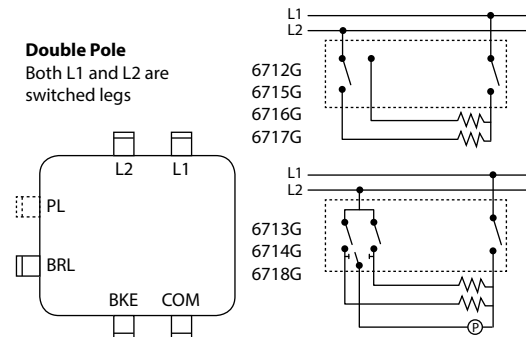

# ELECTRIC OVEN THERMOSTATS

## Electric Oven Thermostat Cross Reference

OEM Part #	ERP #	ERP Kit #
<b>AMANA</b> <i>See Whirlpool</i>		
<b>BROWN</b>		
1842A18	ER1842A18	ER6703S0001
1842A34	ER1842A18	ER6703S0001
1842A38	ER1842A18	ER6703S0001
1842A45*	ERWB24X5252	ER6713S0001
1842A49*	ERWB24X5285	ER6707S0003
1842A54	ER1842A54	✗
1842A57	ER1842A57	✗
1842A59	ER1842A59	✗
<b>ELECTROLUX</b>		
316028600	ER316028600	✗
316114600	ER316114600	✗
316215901	ER316215901	✗
5303285955*		ER6703S0001
5304457303	ER5304457303	✗
<b>GE/HOTPOINT</b>		
164D2640P002	ERWB21X5287	✗
223C4029P001	ERWB20K10026	✗
223C4029P002	ERWB20K10010	✗
WB20K10004	ERWB20K10004	✗
WB20K10007	ERWB20K10026	✗
WB20K10010	ERWB20K10010	✗
WB20K10026	ERWB20K10026	✗
WB20K5018	ERWB20K5018	ER6707S0002
WB20K5027	ERWB20K5027	✗
WB20K5031	ERWB20K5031	✗
WB20X5071	ERWB20X5071	✗
WB21X489	ERWB21X489	ER6707S0001
WB21X5287	ERWB21X5287	✗
WB21X10092	ERWB21X10092	✗
WB21X10098	ERWB21X10098	✗
WB24X5252*	ERWB24X5252	ER6713S0001
WB24X5285*	ERWB24X5285	ER6707S0003
WB24X5358		ER6703S0001
<b>GAFFER &amp; SATTLER</b> <i>See Electrolux</i>		
<b>HARPER WYMAN</b>		
6460G0024	ERW10159016	✗
6703G0007	ER1842A18	ER6703S0001
6703G0015	ER2167	✗
6704G0013	ERY00206900	ER6704S0001
6704G0030	ERY07648601	ER6704S0002
6707G0008	ERWB21X489	ER6707S0001
6707G0010	ERWB20K5018	ER6707S0002

\* Electric oven thermostat is NLA from OEM - still available at ERP

OEM Part #	ERP #	ERP Kit #
6707G0011*	ERWB24X5285	ER6707S0003
6713G0018*	ERWB24X5252	ER6713S0001
6713G0020	ER2168	✗
6713G0021	ER1842A54	✗
6725G0005*	ER993-475	✗
<b>INVENSYS</b>		
275-3140-13	ERWB20K5027	✗
275-3140-15	ERWB20K5031	✗
275-3180-00	ERWB21X5287	✗
275-3200-00	ERWB20K5027	✗
275-3209-00	ERWB20K5031	✗
275-3334-01	ER3196803	✗
275-3369-03	ER74005019	✗
275-3450-00	ER316215901	✗
275-3492-00	ER5304457303	✗
275-3493-00	ER1842A59	✗
275-3506-00	ER3196803	✗
275-3509-00	ER5304457303	✗
275-5014-00	ER74005019	✗
EA5F-479-28	ERWB20K5071	✗
EA5F-488-28	ERWB20K10004	✗
EA5TB-459-18	ER316114600	✗
QE222848	ER316028600	✗
QE222848P	ER316028600	✗
<b>MAYTAG</b> <i>See Whirlpool</i>		
<b>PEERLESS PREMIER</b>		
2167	ER2167	✗
2168	ER2168	ER6713S0002
<b>WHIRLPOOL</b>		
0088758	ERY00206900	ER6704S0001
0311775	ERY07648601	ER6704S0002
334897		ER6707S0001
3196803	ER3196803	✗
4157565	ERY00206900	ER6704S0001
4320548	ERY07648601	ER6704S0002
4337360		ER6707S0001
660534	ER660534	✗
74005019	ER74005019	✗
8190613	ER8190613	ER6713S0002
993-475*	ER993-475	✗
W10159016	ERW10159016	✗
THS022	ERWB20K5018	ER6707S0002
Y00206900	ERY00206900	ER6704S0001
Y07648601	ERY07648601	ER6704S0002

For up-to-date cross reference, go to [www.erparts.com](http://www.erparts.com)



# RECEPTACLES

## Order No. ERR117

Why stock three kits when you can get ERP's at one low price?  
Sturdy brackets and bronze contacts supply reliability in this universal part.

Universal Replacement for OEM and Supco versions:  
Electrolux #5303935058, #5303912666, #5301167733  
General Electric #WB17X210  
Whirlpool #330031  
Supco #RR117, #RR110, #RR109

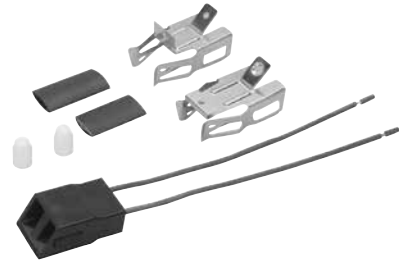

## Order No. ER12001676

Replacement for:  
Whirlpool #12001676

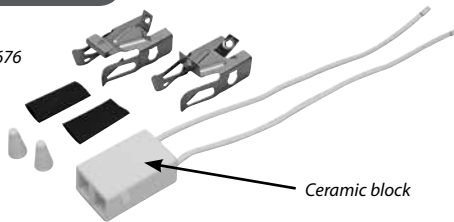

## Order No. ERWB17T10006

Replacement for:  
GE #WB17T10006

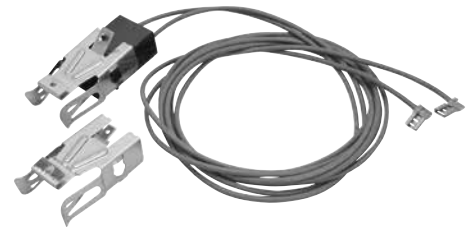

## Order No. ERWB17X5051

Nickel plated bronze contacts insure performance and long life  
to give OEM performance at an ERP price.

Replacement for:  
GE #WB17X5051, #WB17X5000  
Supco #RR122

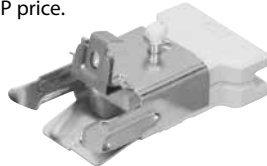

## Order No. ERWB17X5113

Replacement for:  
GE #WB17X5113

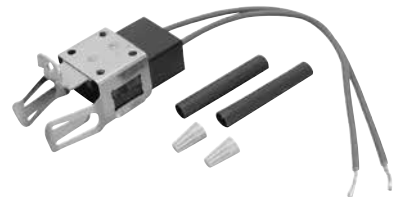

# LET ERP PROMOTE FOR YOU!

**We can create  
custom flyers/mailers  
for all our authorized  
ERP distributors**

**Call for details  
800-377-1355**

# SURFACE ELEMENTS

## REPLACEMENTS FOR ELECTROLUX, GE/HOTPOINT, WHIRLPOOL

Engineered to OEM specifications

### Order No. ERS218

1000W@208V  
1325W@240V

6" - 5 Turn  
Also fits:  
Gemline #SU117  
Supco/Chromalox  
#CH30X218  
Zoppas #TS30X218

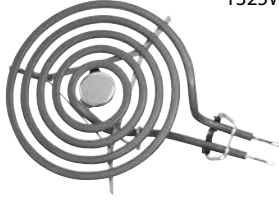

Replaces GE #WB30X218

### Order No. ERS219

1765W@208V  
2350W@240V

8" - 6 Turn  
Also fits:  
Gemline #SU118  
Supco/Chromalox  
#CH30X219  
Zoppas #TS30X219

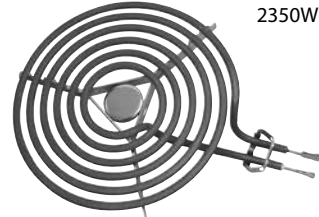

Replaces GE #WB30X219

### Order No. ERS30M1

1000W@208V  
1325W@240V

6" - 5 Turn  
Also fits:  
Gemline #SU121  
Supco/Chromalox  
#CH30M1  
Zoppas #TS30M0001

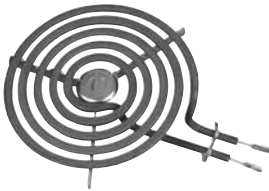

Replaces GE #WB30M1

### Order No. ERS30M2

1765W@208V  
2350W@240V

8" - 6 Turn  
Also fits:  
Gemline #SU122  
Supco/Chromalox  
#CH30M2  
Zoppas #TS30M0002

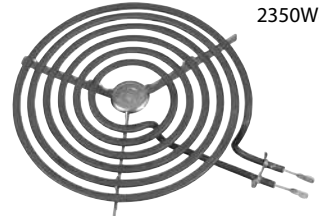

Replaces GE #WB30M2

### Order No. ERS341

1600W@208V  
2125W@240V

8" - 6 Turn  
Also fits:  
Gemline  
#SU119  
Supco/Chromalox  
#CH30X341

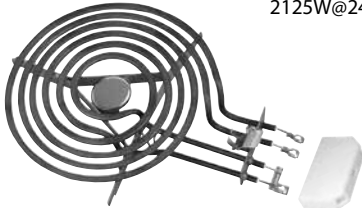

Replaces GE #WB30X341

### Order No. ERS342

1000W@208V  
1325W@240V

6" - 5 Turn  
Also fits:  
Gemline  
#SU120  
Supco/Chromalox  
#CH30X342

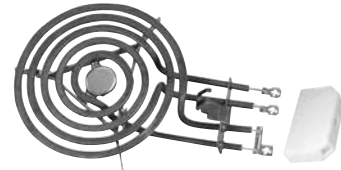

Replaces GE #WB30X342

### Order No. ERS348

1765W@208V  
2350W@240V

8" - 6 Turn  
Also fits:  
Gemline  
#SU348  
Supco/Chromalox  
#CH30X348

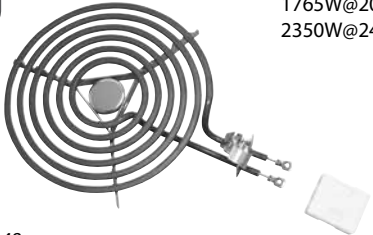

Replaces GE #WB30X348

### Order No. ERS354

1600W@208V  
2125W@240V

8" - 6 Turn  
Also fits:  
Gemline #SU116  
Supco/Chromalox  
#CH30X354

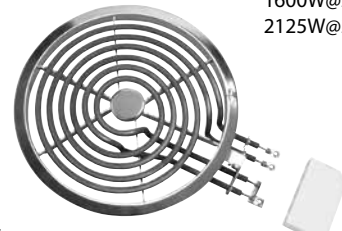

Replaces GE #WB30X354

### Order No. ERS356

1000W@208V  
1325W@240V

6" - 5 Turn  
Also fits:  
Gemline #SU115  
Supco/Chromalox  
#CH30X356



Replaces GE #WB30X356

### Order No. ERS359

1000W@208V  
1325W@240V

6" - 5 Turn  
Also fits:  
Gemline #SU359  
Supco/Chromalox  
#CH30X359



Replaces GE #WB30X359

# SURFACE ELEMENTS

## REPLACEMENTS FOR ELECTROLUX, GE/HOTPOINT, WHIRLPOOL

Engineered to OEM specifications

Order No. ERS30K10002

940W@208V  
1250W@240V

6" - 3 Turn

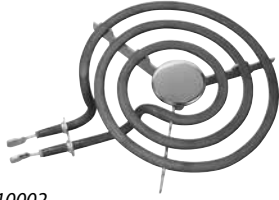

Replaces GE #WB30K10002

Order No. ERS30K10003

1580W@208V  
2100W@240V

8" - 4 Turn

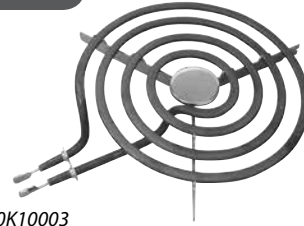

Replaces GE #WB30K10003

Order No. ERS30T10074

1950W@208V  
2600W@240V

8" - 5 Turn

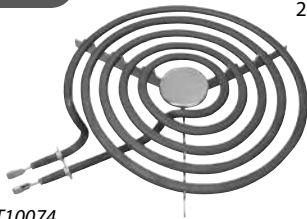

Replaces GE #WB30T10074

Order No. ERS30T10078

1130W@208V  
1500W@240V

6" - 4 Turn

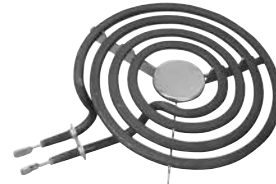

Replaces GE #WB30T10078

Order No. ER8273992

Radiant Heating Element  
For glass cooktops and  
freestanding ranges  
10" - 2500W - 240V

**NEW!**

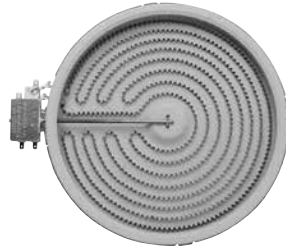

Replaces Whirlpool #8273992

Order No. ERRS65D12

Radiant Heating Element  
For glass cooktops and  
freestanding ranges  
6-1/2" - 1200W - 240V

**NEW!**

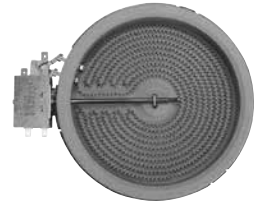

Replaces Electrolux #318178110,  
Whirlpool #8273994

Order No. ERRS85D20

Radiant Heating Element  
For glass cooktops and  
freestanding ranges  
8-1/2" - 2000W - 240V

**NEW!**

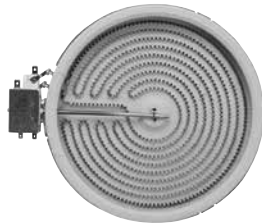

Replaces GE #WB30T10132,  
Whirlpool #W10242957

Order No. ERWB30T10044

Radiant Heating Element  
For glass cooktops and  
freestanding ranges  
10" - 2500 watts

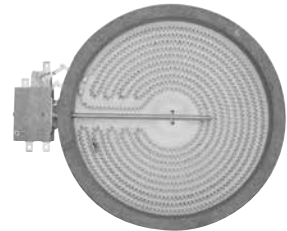

Replaces GE #WB30T10044

Order No. ERWB30T10045

Radiant Heating Element  
For glass cooktops and  
freestanding ranges  
8-1/2" - 2000 watts

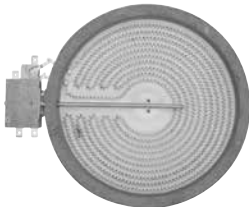

Replaces GE #WB30T10045

Order No. ERWB30T10047

Radiant Heating Element  
For glass cooktops and  
freestanding ranges  
7" - 1500 watts

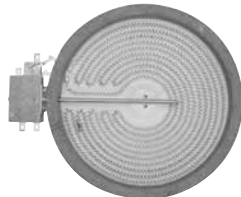

Replaces GE #WB30T10047

# SURFACE ELEMENTS

## REPLACEMENTS FOR ELECTROLUX, GE/HOTPOINT, WHIRLPOOL

Engineered to OEM specifications

### Reading ERP Universal Surface Element Part Number

All Elements are 240 volts unless followed by - 120V

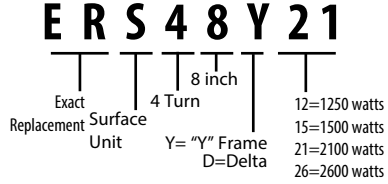

### Order No. ERS36Y12

6" - 3 Turn  
Also fits:  
Gemline #SU201  
Supco/Chromalox  
#SP12YA  
Zoppas  
#TS3W6212

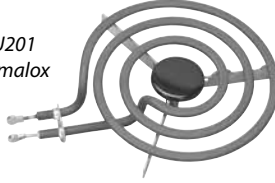

### Order No. ERS36Y11-120V

6" - 3 Turn  
Also fits:  
Chromalox  
#SP111YA  
Gemline  
#SU207  
Zoppas  
#TS3W6111

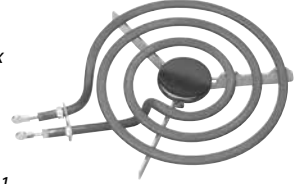

### Order No. ERS46Y12

6" - 4 Turn  
Also fits:  
Gemline #SU203  
Supco/Chromalox  
#MP12YA  
Zoppas  
#TS4W6212

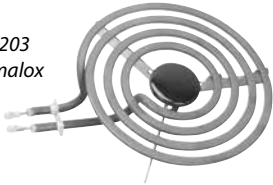

### Order No. ERS46Y15

6" - 4 Turn  
Also fits:  
Gemline #SU205  
Supco/Chromalox  
#MP15YA  
Zoppas  
#TS4W6215

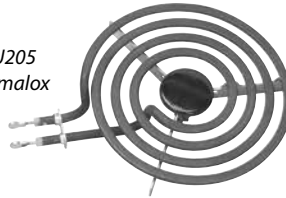

### Order No. ERS48Y21

8" - 4 Turn  
Also fits:  
Gemline #SU202  
Supco/Chromalox  
#SP21YA  
Zoppas  
#TS4W8221

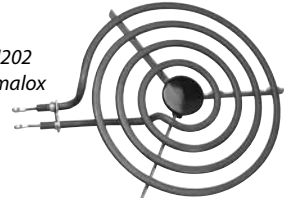

### Order No. ERS58Y21

8" - 5 Turn  
Also fits:  
Gemline #SU204  
Supco/Chromalox  
#MP21YA  
Zoppas  
#TS5W8221



### Order No. ERS58Y26

8" - 5 Turn  
Also fits:  
Gemline #SU206  
Supco/Chromalox  
#MP26YA  
Zoppas  
#TS5W8226

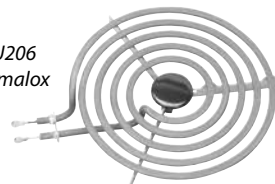

### Order No. ERS58D26-CAN

8" - 5 Turn  
Also fits:  
Heavy duty base  
for canning or  
wok cooking



### Order No. ERS36D12

6" - 3 Turn  
Also fits:  
Gemline #SU301  
Supco/Chromalox  
#SP12MA  
Zoppas  
#TS3D6212

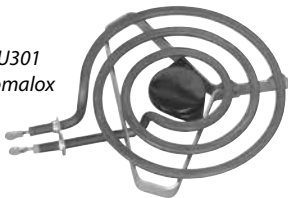

### Order No. ERS46D12

6" - 4 Turn  
Also fits:  
Gemline #SU303  
Supco/Chromalox  
#MP12MA  
Zoppas  
#TS4D6212

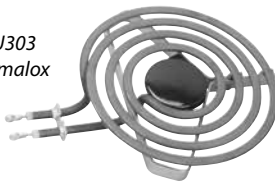

### Order No. ERS46D15

6" - 4 Turn  
Also fits:  
Gemline #SU304  
Supco/Chromalox  
#MP15MA  
Zoppas  
#TS4D6215

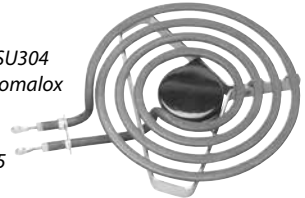

### Order No. ERS48D21

8" - 4 Turn  
Also fits:  
Gemline #SU302  
Supco/Chromalox  
#SP21MA  
Zoppas  
#TS4D8221



### Order No. ERS58D21

8" - 5 Turn  
Also fits:  
Gemline #SU305  
Supco/Chromalox  
#MP21MA  
Zoppas  
#TS5D8221

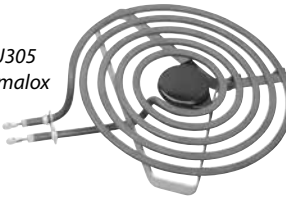

### Order No. ERS58D26

8" - 5 Turn  
Also fits:  
Gemline #SU306  
Supco/Chromalox  
#MP26MA  
Zoppas  
#TS5D8226

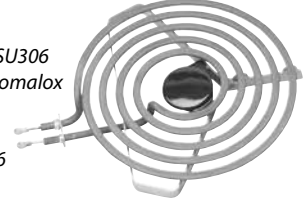



# DRIP PANS

## Order No. DBU6

6" Universal Drip Pan

Also fits:  
#DP6BR  
#DP212  
#771-6



## Order No. DBU6P

6" Universal Drip Pan

Also fits:  
#5304430149  
#WB32K5041



## Order No. DBU8

8" Universal Drip Pan

Also fits:  
#DP8BR  
#DP213  
#770-8



## Order No. DBU8P

8" Universal Drip Pan

Also fits:  
#5303935053  
#WB32K5042



## Order No. DPU6

6" Universal Drip Pan

Also fits:  
#DP6U  
#DP116  
#601-6



## Order No. DPU8

8" Universal Drip Pan

Also fits:  
#DP8U  
#DP117  
#602-8



## Order No. DB6WE

6" Electrolux Drip Pan

Also fits:  
#5300147221  
#Q147221  
#221-6



## Order No. DB8WE

8" Electrolux Drip Pan

Also fits:  
#5300147223  
#Q147223  
#223-8



## Order No. DB6GE

6" GE Drip Pan

Also fits:  
#WB31X5010  
#DP201  
#5010-6  
#4378454



## Order No. DB6GE1

6" GE Drip Pan

Also fits:  
#WB32X5075  
#DP164  
#5075-6



## Order No. DB6GE2

6" GE Drip Pan

Also fits:  
#WB31K5024  
#4389591



## Order No. DB8GE

8" GE Drip Pan

Also fits:  
#WB31X5011  
#DP202  
#5011-8  
#4378456





# DRIP PANS

## Order No. DB8GE1

8" GE Drip Pan  
 Also fits:  
 #WB32X5076  
 #DP165  
 #5076-8



## Order No. DB8GE2

8" GE Drip Pan  
 Also fits:  
 #WB31K5025  
 #4389592



## Order No. DP6GE

6" GE Drip Pan  
 Also fits:  
 #WB32X5045  
 #DP6S  
 #DP214  
 #DP114  
 #501-6  
 #19950017



## Order No. DP8GE

8" GE Drip Pan  
 Also fits:  
 #WB32X5036  
 #DP8S  
 #DP115  
 #500-8  
 #19950018



## Order No. TR6GE

6" GE Trim Ring  
 Also fits:  
 #WB31X5013  
 #DP104  
 #DP204  
 #GT-6



## Order No. TR8GE

8" GE Trim Ring  
 Also fits:  
 #WB31X5014  
 #DP105  
 #DP205  
 #GT-8



## Order No. DB6WH

6" Whirlpool Drip Pan  
 Also fits:  
 #3150246  
 #DP233  
 #751-6  
 #93150246  
 #W10196406



## Order No. DB8WH

8" Whirlpool Drip Pan  
 Also fits:  
 #3150247  
 #DP234  
 #750-8  
 #93150247  
 #W10196405



## Order No. DB6WHP

6" Whirlpool Drip Pan  
 Also fits:  
 #W10290353



## Order No. DB8WHP

8" Whirlpool Drip Pan  
 Also fits: #W10290350



## Order No. ER786333

6" Whirlpool Gas Drip Pan  
 Also fits: #786333, #Y0063990



# INFINITE SWITCHES

## Order No. ER5500200

Universal kit  
240V, 13 amp  
Includes square breakoff shaft with multiple nylon adapter inserts for virtually all of knobs used by Electrolux, GE, Maytag, Whirlpool and others.  
Includes instruction sheet

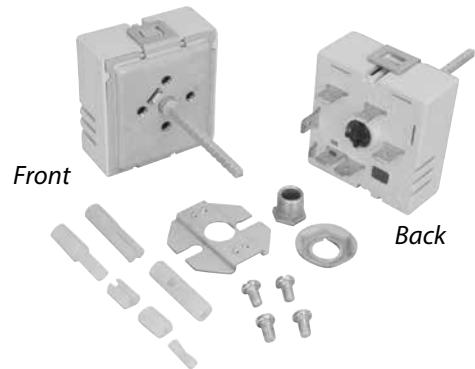
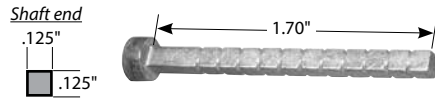

Voltage sensing type with double line break

## Order No. ER5500200M

Universal kit - 240V, 13 amp  
Includes square breakoff shaft with multiple nylon adapter inserts for virtually all of knobs used by Electrolux, GE, Maytag, Whirlpool and others.  
Includes instruction sheet

Direct Replacement for 95% of INF240P series switches including:  
Electrolux INF240PX-803, INF240PX-1198, 5303935086  
GE INF240PX-1002, INF240PX-1190, WB21X5243  
Whirlpool INF240P-1217, 4391991

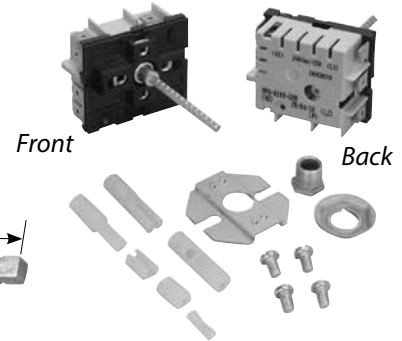
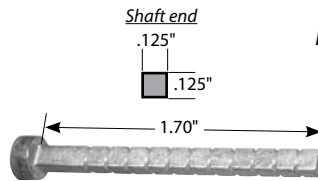

Voltage sensing type - compact design including new UL, CE and CSA double line break feature.

## Order No. ER1841L61

240V, 5.2 - 6.25 amp  
Replacement for Brown

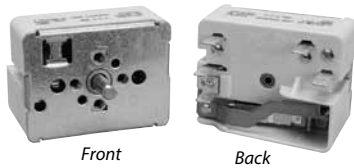

Current sensing type

## Order No. ER1841L62

240V, 8.8 - 10.8 amp  
Replacement for Brown

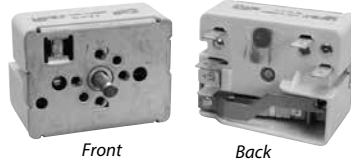

Current sensing type

## Order No. ER316238200

240V, 13 amp  
6 terminals  
Replacement for Electrolux

**NEW!**

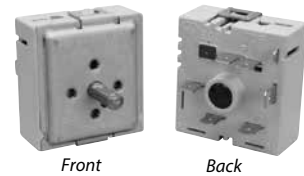

Voltage sensing type

## Order No. ER316436000

240V, 5.2 - 6.25 amp  
1250 - 1500 watts  
Replacement for Electrolux

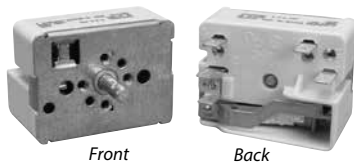

Current sensing type

## Order No. ER316436001

240V, 8.8 - 10.8 amp  
2100 - 2600 watts  
Replacement for Electrolux

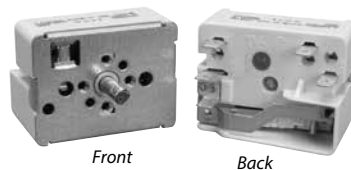

Current sensing type

## Order No. ERWB21X10090

Oven selector switch  
Has (9) .250" male terminals  
Replacement for GE

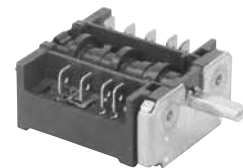

# INFINITE SWITCHES

## Order No. ERWB21X10091

240V, 13 amp  
8 terminals  
Replacement for GE

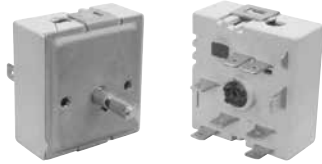

Front Back

Voltage sensing type

## Order No. ERWB23K5027

240V, 8.9 - 11.0 amp  
Replacement for GE



Front Back

Current sensing type

## Order No. ERWB23M2

240V, 4.8 - 6.2 amp  
Replacement for GE

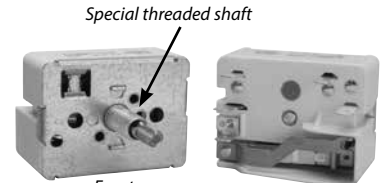

Special threaded shaft

Front Back

Current sensing type

## Order No. ERWB23M23

240V, 8.9 - 11.0 amp  
Replacement for GE



Front Back

Current sensing type

## Order No. ERWB23M24

240V, 5.2 - 6.6 amp  
Replacement for GE



Front Back

Current sensing type

## Order No. ERWB24T10022

240V, 4.4 - 5.8 amp  
1250 watts  
Replacement for GE



Front Back

Current sensing type

## Order No. ERWB24T10025

240V, 8.9 - 11.0 amp  
2600 watts  
Replacement for GE



Front Back

Current sensing type

## Order No. ERWB24T10027

240V, 7.5 - 9.3 amp  
2040 watts  
Replacement for GE

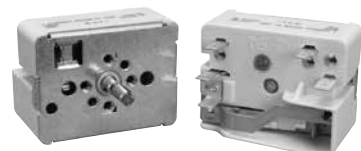

Front Back

Current sensing type

## Order No. ERWB24T10029

240V, 4.4 - 7.4 amp  
1560 watts  
Replacement for GE



Front Back

Current sensing type

## Order No. ERWB24T10058

240V, 13 amp  
6 terminals  
Replacement for GE



Front Back

Voltage sensing type

## Order No. ERWB24T10063

240V, 13 amp  
8 terminals - dual wattage  
Includes jumper wire & instruction sheet  
Replacement for GE

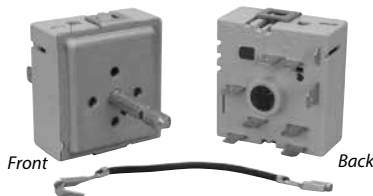

Front Back

## Order No. ERWB24T10119

240V, 13 amp  
6 terminals  
Replacement for GE



Front Back

Voltage sensing type

# INFINITE SWITCHES

Order No. ERWB24T10153

240V, 13 amp  
8 terminals  
Replacement for GE

**NEW!**

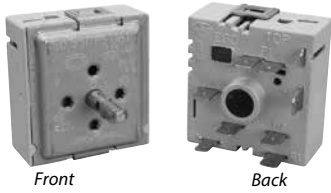

Front

Back

Voltage sensing type

Order No. ER2286

240V, 5.4 - 7 amp  
Replacement for Peerless

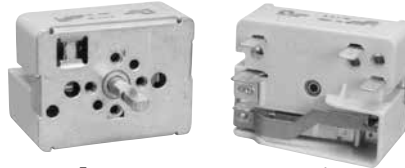

Front

Back

Current sensing type

Order No. ER2287

240V, 8.9 - 11 amp  
Replacement for Peerless



Front

Back

Current sensing type

Order No. ER12002121

240V, 13 amp  
8 terminals - dual wattage  
Replacement for Whirlpool

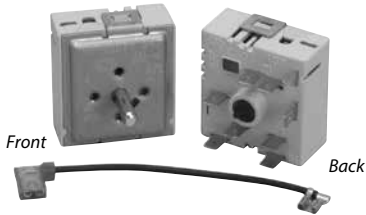

Front

Back

Order No. ER12002125

240V, 13 amp  
8 terminals - dual wattage  
Replacement for Whirlpool



Front

Back

Order No. ER3148952

240V, 5.4 - 7.8 amp  
Replacement for Whirlpool

**NEW!**



Front

Back

Current sensing type

Order No. ER3149400

240V, 8.9 - 11.0 amp  
Replacement for Whirlpool



Front

Back

Current sensing type

Order No. ER3149404

240V, 5.2 - 6.6 amp  
Replacement for Whirlpool



Front

Back

Current sensing type

Order No. ER4456027

240V, 13 amp  
8 terminals  
Replacement for Whirlpool

**NEW!**

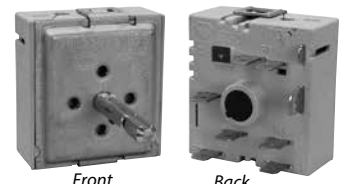

Front

Back

Voltage sensing type

Order No. ER74003122

240V, 13 amp  
7 terminals  
Replacement for Whirlpool

**NEW!**



Front

Back

Voltage sensing type

Order No. ER74008248

240V, 13 amp  
8 terminals - dual wattage  
Replacement for Whirlpool



Front

Back

Order No. ER74011242

240V, 13 amp  
7 terminals  
Replacement for Whirlpool

**NEW!**



Front

Back

Voltage sensing type

# INFINITE SWITCHES

## Order No. ER74011243

240V, 13 amp  
7 terminals  
Replacement for Whirlpool



Front Back

Voltage sensing type

## Order No. ER7403P23860

240V, 5.2 - 6.6 amp  
Replacement for Whirlpool



Front Back

Current sensing type

## Order No. ER7403P23960

240V, 8.9 - 11.0 amp  
Replacement for Whirlpool



Front Back

Current sensing type

## Order No. ER7403P28960

240V, 8.9 - 11 amp  
Replacement for Whirlpool



Front Back

Current sensing type

## Order No. ER8203536

240V, 13 amp  
8 terminals - dual wattage  
Replacement for Whirlpool

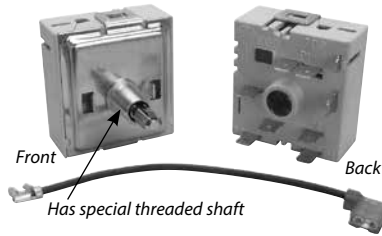

Front Back

Has special threaded shaft

## Order No. ER9757030

240V, 13 amp  
8 terminals - dual wattage  
Replacement for Whirlpool



Front Back

Voltage sensing type

## Order No. ER9758060

240V, 13 amp  
8 terminals - dual wattage  
Replacement for Whirlpool



Front Back

Voltage sensing type

## Order No. ERW10197679

240V, 5.3 - 6.4 amp  
Replacement for Whirlpool



Front Back

Current sensing type

## Order No. ERW10197681

240V, 8.9 - 11.0 amp  
Replacement for Whirlpool

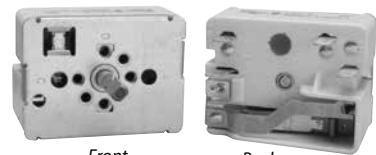

Front Back

Current sensing type

## Order No. ER5500202

Universal kit  
Non-push to turn  
240V, 13 amp

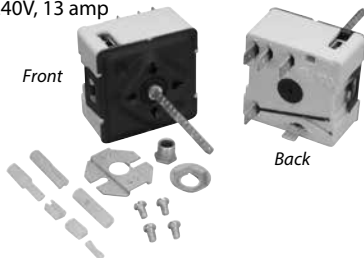

Front Back

## Order No. ER5500287

240V, 13 amp



Front Back

Voltage sensing type

## Order No. ER5502350

Non-push to turn  
240V, 15 amp



Front Back

Voltage sensing type



# INFINITE SWITCHES

## Order No. ER5502404

Non-push to turn  
240V  
15 amp



Front

Back

Voltage sensing type

## Order No. ER5500134

Heavy duty commercial infinite kit  
Non-push to turn  
120V, 15 amp  
Includes black knob, jumper wires and adapter fittings

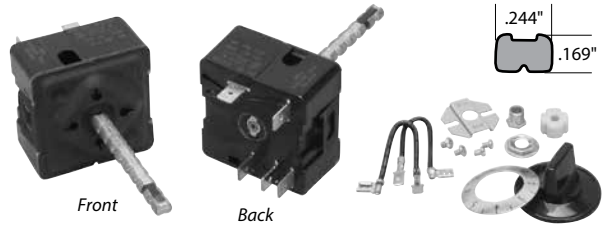

Front

Back

Shaft end

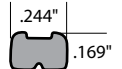

## Order No. ER5500203



Universal kit  
Non-push to turn  
240V, 13 amp  
Includes black knob and adapter fittings

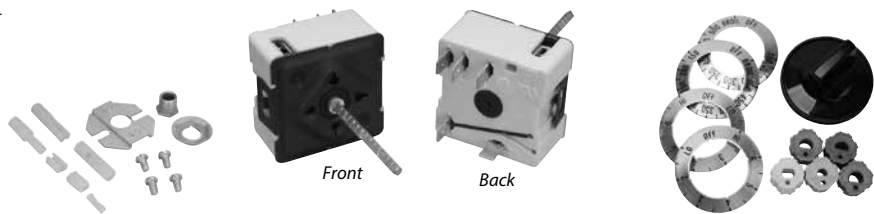

Front

Back

## Order No. ER5500212

Universal kit  
240V, 15 amp  
Replacement for most small "D" stem older GE infinities.

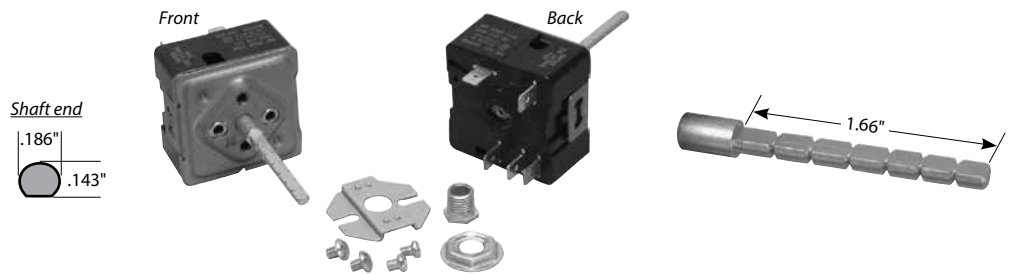

Front

Back

Shaft end

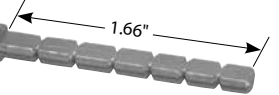

## Order No. ER5500234

Heavy duty commercial infinite kit  
Non-push to turn  
240V, 15 amp  
Includes black knob, jumper wires and adapter fittings



Front

Back

Shaft end

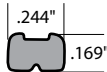

## Order No. ER5500235

Heavy duty commercial infinite kit  
Non-push to turn  
240V, 15 amp  
Includes white knob, jumper wires and adapter fittings

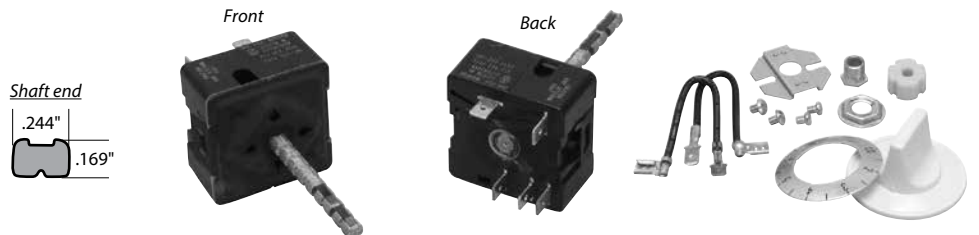

Front

Back

Shaft end

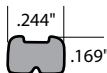

# INFINITE SWITCHES

## Infinite Switch Cross Reference

OEM Part #	ERP #
<b>AMANA</b> <i>See Whirlpool</i>	
<b>BROWN</b>	
1841L39	ER1841L61
1841L40	ER1841L62
1841L51	ER1841L61
1841L52	ER1841L62
1841L53	ER1841L61
1841L54	ER1841L62
1841L55	ER1841L61
1841L56	ER1841L62
1841L61	ER1841L61
1841L62	ER1841L62
<b>ELECTROLUX</b>	
316021500	ER316436000
316021501	ER316436001
316238200	ER316238200
316436000	ER316436000
316436001	ER316436001
5303935086	ER5500200
<b>GE/HOTPOINT</b>	
191D2990P001	ERWB24T10058
191D2990P004	ERWB24T100119
229C4709P003°	ERWB24T10063
WB21X10090	ERWB21X10090
WB21X10091	ERWB21X10091
WB21X163*	ER5500212
WB21X183*	ER5500212
WB21X209*	ER5500212
WB21X211*	ER5500212
WB21X222*	ER5500212
WB21X226*	ER5500212
WB21X227*	ER5500212
WB21X228*	ER5500212
WB21X230*	ER5500212
WB21X233*	ER5500212
WB21X237*	ER5500212
WB21X239*	ER5500212
WB21X240*	ER5500212
WB21X244*	ER5500212
WB21X5198*	ER5500212
WB21X5217	ER5500212
WB21X5243	ER5500200 or ER5500212
WB21X5353	ER5500212

OEM Part #	ERP #
WB23K5027	ERWB23K5027
WB23M2	ERWB23M2
WB23M23	ERWB23M23
WB23M24	ERWB23M24
WB24T10022	ERWB24T10022
WB24T10025	ERWB24T10025
WB24T10027	ERWB24T10027
WB24T10029	ERWB24T10029
WB24T10153	ERWB24T10153
WB24T10058	ERWB24T10058
WB24T10063	ERWB24T10063
WB24T10119	ERWB24T10119
<b>INVENSYS</b>	
5500-134	ER5500134
5500-200	ER5500200
5500-200M	ER5500200M
5500-202	ER5500202
5500-203	ER5500203
5500-212	ER5500212
5500-234	ER5500234
5500-235	ER5500235
5500-287	ER5500287
5502-350	ER5502350
5502-404	ER5502404
5502-428	ER5500200
5502-512	ER5500200
66004-24AF	ER1841L61
66004-34AF	ER1841L62
INF240-76	ER5502350
INF240-202	ER5502404
INF240-597	ER5500202
INF240-1152	ER5500134
INF240-1153	ER5500234
INF240-1163	ER5500134
INF240P-1028	ER5500200
INF240P-1047	ER5500287
INF240P-1148	ER5500212
INF240P-1202	ER5500200
INF240P-1242	ER5500200
INF240P-672	ER5500200
INF240P-928	ER5500212
INF240PX-803	ER5500200M
INF240PX-1002	ER5500200M
INF240PX-1190	ER5500200M

OEM Part #	ERP #
INF240PX-1198	ER5500200M
NL811214	ERWB24T10022
NL811300	ERWB23M2
NL811420	ER7403P23860
NL811440	ER3149404
NL811441	ER1841L61
NL811444	ERWB23M24
NL811458	ER316436000
NL811530	ERW10197679
NL811600	ERWB24T10029
NL812116	ER1841L62
NL812118	ERWB24T10027
NL812404	ERWB23M1
NL812448	ER316436001
NL812616	ER7403P23960
NL812633	ER7403P28960
NL812637	ERWB23M23
NL812639	ER3149400
NL812641	ERWB23K5027
NL812653	ERWB24T10025
NL812660	ERW10197681
NL831473	ER1841L61
NL832458	ER1841L62
QE214311	ER316436000
QE214312	ER316436001
QE214339	ER1841L61
QE214340	ER1841L62
QE214453	ER1841L61
QE214454	ER1841L62
QE214519	ER2286
QE214520	ER2287
<b>MAYTAG</b> <i>See Whirlpool</i>	
<b>PEERLESS PREMIER</b>	
2282	ER2286
2283	ER2287
2286	ER2286
2287	ER2287
<b>ROBERTSHAW</b> <i>See Invensys</i>	
<b>ROPER</b> <i>See Whirlpool</i>	
<b>SLATTERY</b>	
28009*	ER5500200
28010*	ER5500200
<b>WHIRLPOOL</b>	
0052772	ER5500200

OEM Part #	ERP #
12002121	ER12002121
12002125	ER12002125
3148952	ER3148952
3149400	ER3149400
3149404	ER3149404
31891202	ER74011243
32069501	ER74011243
4157978	ER5522200
4364179	ERW10197679
4364180	ERW10197681
4391989	ER5500200
4456027	ER4456027
74003122	ER74003122
74008214	ER74011243
74008248	ER74008248
74011242	ER74011242
74011243	ER74011243
7403P23860	ER7403P23860
7403P23960	ER7403P23960
7403P28960	ER7403P28960
7403P83160	ER12002125
7403P81660	ER12002121
7450P02060	ER74011243
814378	ER5500200
8203536	ER8203536
9755175	ER8203536
9757030	ER9757030
9758060	ER9758060
R0702021	ER5500200
W10197679	ERW10197679
W10197681	ERW10197681
Y0045473	ER5500200
Y0088872*	ER5500200
Y0088873*	ER5500200
Y0089709*	ER5500200
Y0089710*	ER5500200
Y0090086*	ER5500200
Y0310225*	ER5500200
Y0315124*	ER5500200
Y07434901*	ER5500200
Y07540700	ER5500200
Y07540704*	ER5500200
Y3015563	ER74011243

\* Infinite switch is NLA from OEM - still available at ERP

For up-to-date cross reference, go to [www.erparts.com](http://www.erparts.com)

# TOP BURNER GRATES

**Order No. ER3018432**

8-5/8" x 8-5/8"

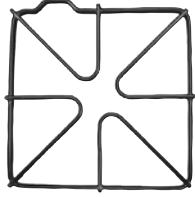

Replacement  
for Electrolux

**Order No. ER316055800**

6-1/2" diameter

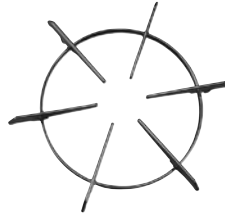

Replacement  
for Electrolux

**Order No. ER316088900**

8-5/8" x 8-5/8"  
1-3/8" height

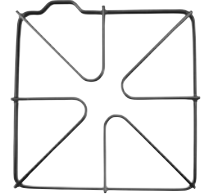

Replacement  
for Electrolux

**Order No. ER5301321001**

7-5/8" diameter

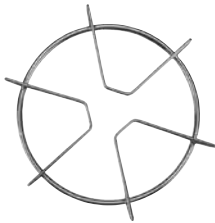

Replacement  
for Electrolux

**Order No. ER5303009309**

7-1/2" diameter  
Cast iron



Replacement  
for Electrolux

**Order No. ER5303272274**

7-1/4" diameter

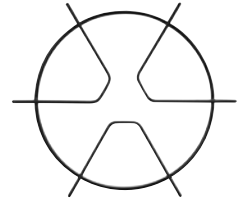

Replacement  
for Electrolux

**Order No. ER5303285720**

7" diameter

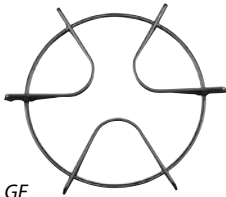

Replacement for  
Brown, Electrolux, GE

**Order No. ERWB31K6**

8-1/2" x 8-1/2"  
1-1/8" height

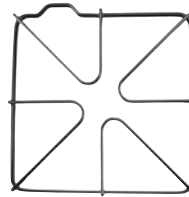

Replacement for GE

**Order No. ERWB31K5027**

7-1/2" diameter



Replacement for GE

**Order No. ERWB31K10012**

8-1/2" x 8-1/2"  
1-1/4" height

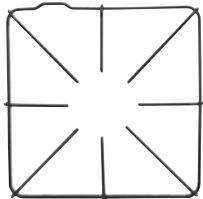

Replacement for GE

**Order No. ER7080**

7-1/4" diameter



Replacement for  
Peerless, Whirlpool

**Order No. ER18014**

7" diameter

NLA  
from  
OEM

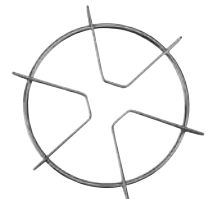

Replacement for  
Slattery

**Order No. ER18015**

7-1/2" diameter

NLA  
from  
OEM



Replacement for  
Slattery

**Order No. ER4332487**

7-3/4" diameter

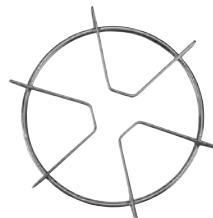

Replacement for  
Whirlpool

**Order No. ER74001086**

8-3/4" x 9"  
1-1/4" height

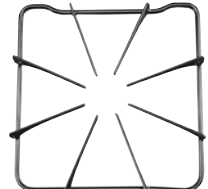

Replacement for  
Whirlpool

# TOP BURNER GRATES

## Order No. ER8053458

8-1/4" x 8-7/8"  
1-5/8" height

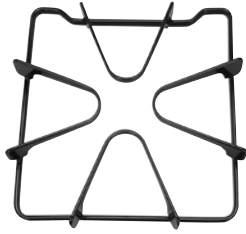

Replacement for Whirlpool

## Order No. ER8189747

7-1/4" diameter  
Cast iron

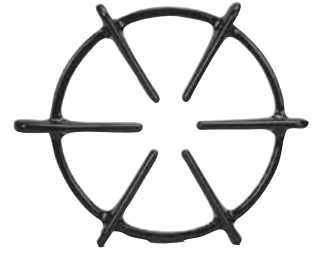

Replacement for Whirlpool

## Order No. ERY07517400

8-1/4" x 8-1/4"

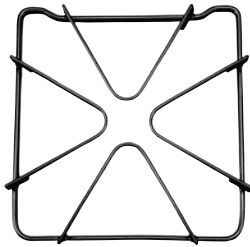

Replacement for Whirlpool

## Order No. ERY07540300

6-1/2" diameter



Replacement for Whirlpool

## Top Burner Grates Cross Reference

OEM PN	ERP PN
<b>BROWN</b>	
5900	ER5900
<b>ELECTROLUX</b>	
3018432*	ER3018432
316055800	ER316055800
316088900*	ER316088900
5301321001	ER5301321001
5303009309	ER5303009309
5303272274	ER5303272274
5303272852	ER3018432 (set of 4)
5303285720	ER5303285720
5308007954*	ER5301321001
<b>GE</b>	
WB31K10012	ERWB31K10012
WB31K5027	ERWB31K5027
WB31K6	ERWB31K6

OEM PN	ERP PN
WB32X5087	ER3018432
WB32X5110*	ERWB32X5110
WB32X87*	ER74001086
WB32X89	ER3018432
<b>LB MFG</b>	
RG001	ERY07540300
RG002	ER5301321001
RG003	ER5303285720
RG005	ER18015
RG014	ER74001086
RG016	ER316055800
RG021	ERY07517400
RG022	ER18014
<b>PEERLESS</b>	
7080	ER7080
7086	ER7086

OEM PN	ERP PN
<b>SLATTERY</b>	
18014*	ER18014
18015*	ER18015
<b>WHIRLPOOL</b>	
4332487*	ER5301321001
4364146	ER4364146
4371085*	ER316055800
4371474*	ER3018432
74001086	ER74001086
8053458	ER8053458
8189747	ER8189747
Y07540300*	ERY07540300
Y07517400	ERY07517400

\* Top burner grate is NLA from OEM - still available at ERP

For up-to-date cross reference, go to [www.erparts.com](http://www.erparts.com)

# BURNER ASSEMBLIES

**Order No. ER1801M53**

**FRONT**

Replacement for  
Brown  
Also fits:  
Electrolux  
#5303297990  
GE  
#WB28X5047  
Harper Wyman  
#2908G0001

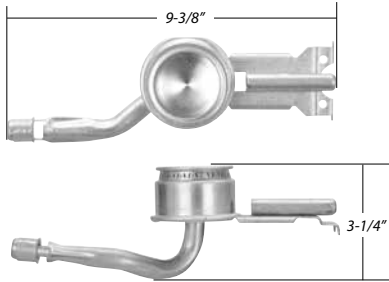

**REAR**

**Order No. ER1801M54**

Replacement for  
Brown  
Also fits:  
Electrolux  
#5303297991  
GE  
#WB28X5049  
Harper Wyman  
#2908G0002

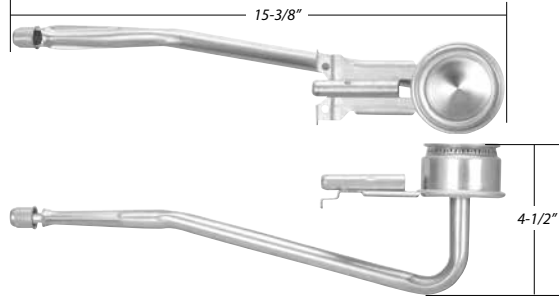

**Order No. ER1801M58**

**FRONT**

Replacement for  
Brown  
Also fits:  
#1801M53

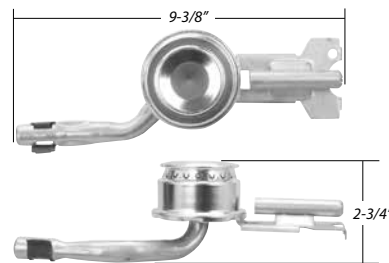

**REAR**

**Order No. ER1801M59**

Replacement for  
Brown  
Also fits:  
#1801M54

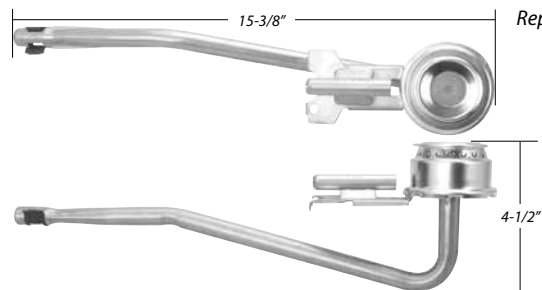

**Order No. ER316039002**

**FRONT**

Replacement for  
Electrolux  
Also fits:  
Whirlpool  
#4371480

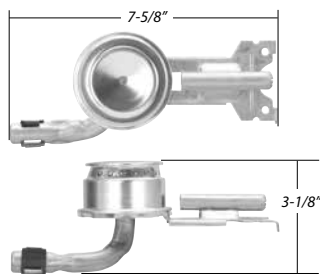

**REAR**

**Order No. ER316039003**

Replacement for  
Electrolux  
Also fits:  
Whirlpool  
#4371481

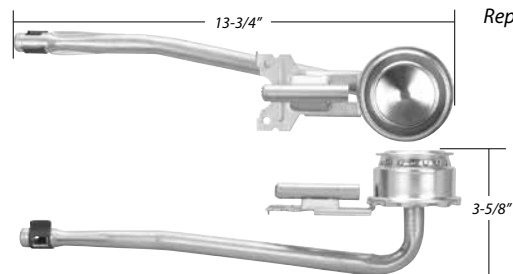

**Order No. ER316103800**

**FRONT**

Replacement for  
Electrolux

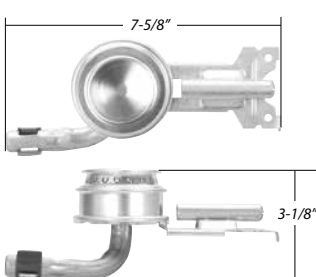

**REAR**

**Order No. ER316103801**

Replacement for  
Electrolux

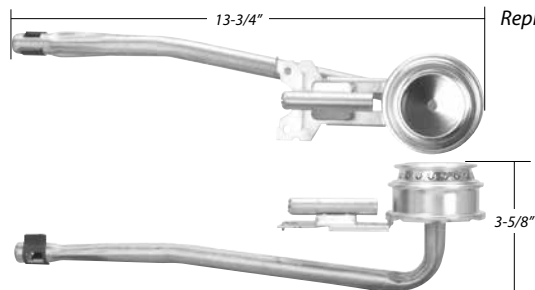

\* SEE PAGE 42 FOR BURNER ASSEMBLIES CROSS REFERENCE\*

All logos, trademarks, part numbers, photos & illustrations are intended solely for identification. Items offered for sale are not represented to be manufactured by the company that built the original equipment.



# BURNER ASSEMBLIES

**Order No. ER5303131080**

**FRONT**

Replacement for  
Electrolux  
Also fits:  
Electrolux  
#5303311551

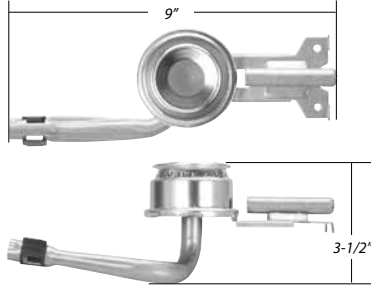

**REAR**

**Order No. ER5303131079**

Replacement for  
Electrolux

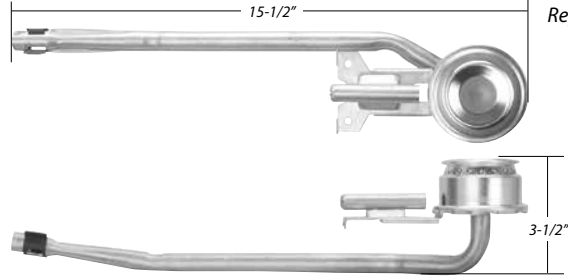

**Order No. ER5303204154**

**FRONT**

Replacement for  
Electrolux  
Also fits:  
GE  
#WB28X5034

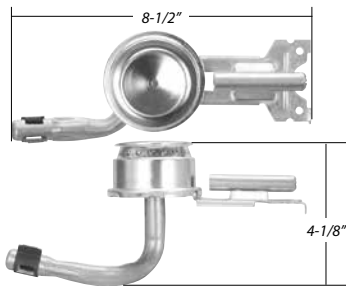

**REAR**

**Order No. ER5303204155**

Replacement for  
Electrolux  
Also fits:  
GE  
#WB28X5035

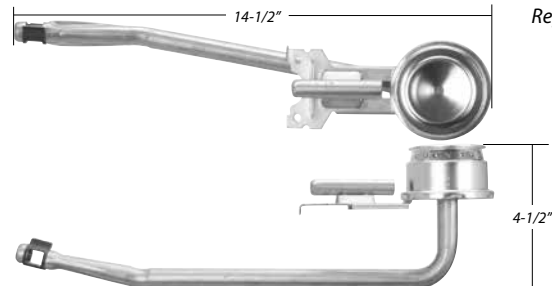

**Order No. ERWB28X112**

**FRONT**

Replacement  
for GE  
Also fits:  
Harper Wyman  
#2908G0036  
Whirlpool  
#4342875

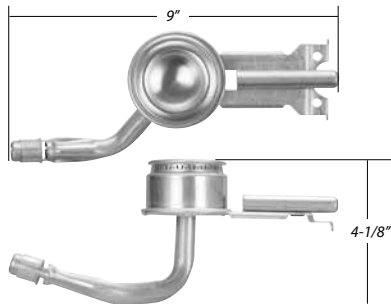

**REAR**

**Order No. ERWB28X111**

Replacement  
for GE  
Also fits:  
Harper Wyman  
#2908G0037  
Whirlpool  
#4342874

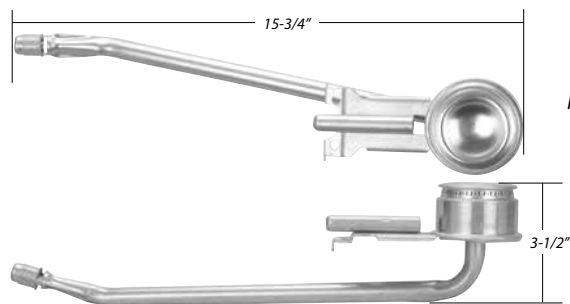

**Order No. ER1398**

**FRONT**

Replacement for  
Peerless  
Also fits:  
Harper Wyman  
#2907G0003

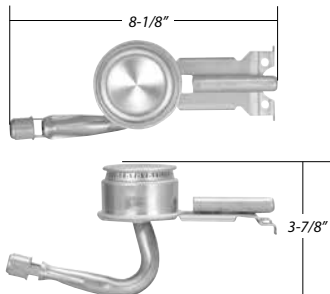

**REAR**

**Order No. ER1399**

Replacement for  
Peerless  
Also fits:  
Harper Wyman  
#2907G0004

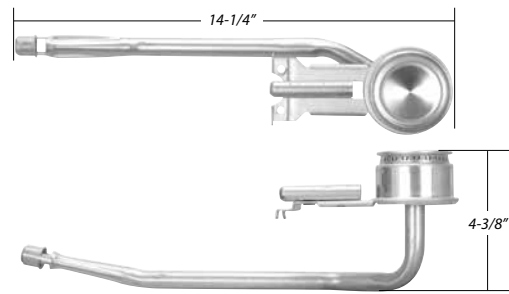

\* SEE PAGE 42 FOR BURNER ASSEMBLIES CROSS REFERENCE\*

All logos, trademarks, part numbers, photos & illustrations are intended solely for identification. Items offered for sale are not represented to be manufactured by the company that built the original equipment.

# BURNER ASSEMBLIES

Order No. ER1404

FRONT

Replacement for  
Peerless  
Also fits:  
Harper Wyman  
#2907G0005

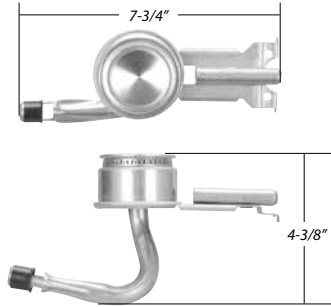

REAR

Order No. ER1405

Replacement for  
Peerless  
Also fits:  
Harper Wyman  
#2907G0006

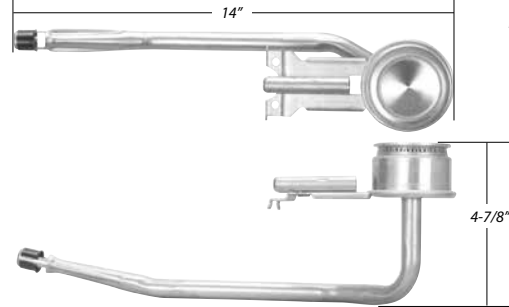

Order No. ER18007

FRONT

Replacement  
for Slattery

NLA  
from  
OEM

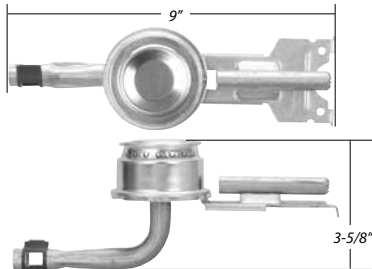

RIGHT REAR

Order No. ER18008

Replacement  
for Slattery

NLA  
from  
OEM

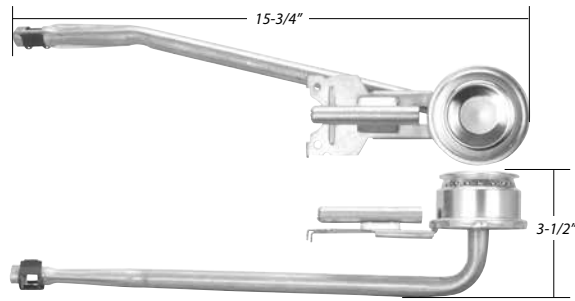

LEFT REAR

Order No. ER18009

Replacement  
for Slattery

NLA  
from  
OEM

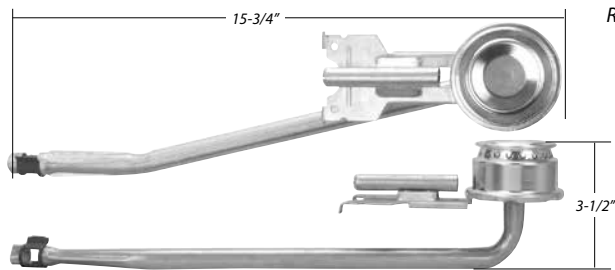

Order No. ER07519400

FRONT

Replacement for  
Whirlpool  
Also fits:  
GE  
#WB28X5027  
Whirlpool  
#Y07519400

NLA  
from  
OEM

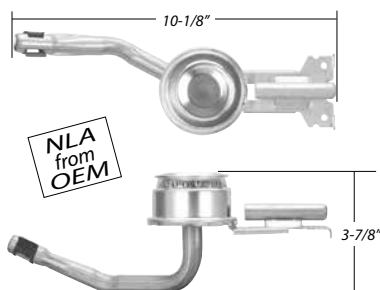

REAR

Order No. ER0052750

Replacement for  
Whirlpool  
Also fits:  
GE  
#WB28X5028  
Whirlpool  
#Y0052750

NLA  
from  
OEM

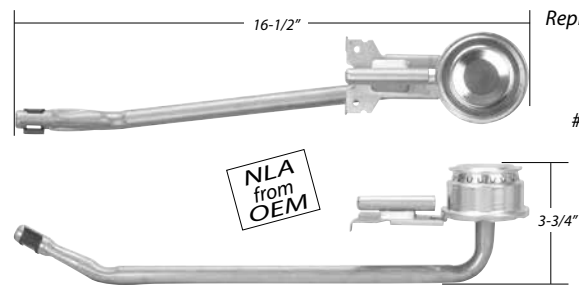

\* SEE PAGE 42 FOR BURNER ASSEMBLIES CROSS REFERENCE\*

All logos, trademarks, part numbers, photos & illustrations are intended solely for identification. Items offered for sale are not represented to be manufactured by the company that built the original equipment.

# BURNER ASSEMBLIES

Order No. ER3186209

LEFT FRONT

Replacement  
for Whirlpool

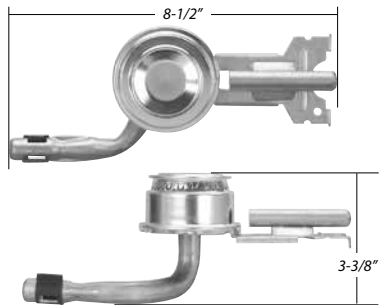

LEFT REAR

Order No. ER3186213

Replacement  
for Whirlpool

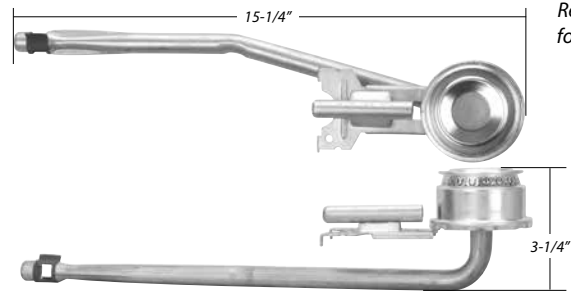

Order No. ER3186214

RIGHT FRONT

Replacement  
for Whirlpool

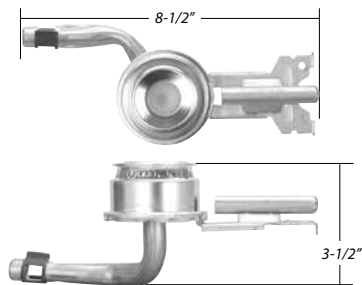

RIGHT REAR

Order No. ER3186215

Replacement  
for Whirlpool

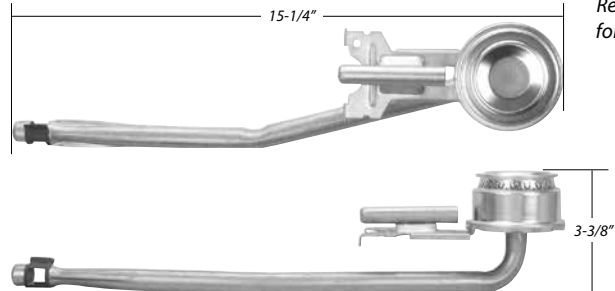

Order No. ER4335161

REAR

Replacement  
for Whirlpool  
Also fits:  
Harper Wyman  
#2908G0104  
Whirlpool  
#327075

NLA  
from  
OEM

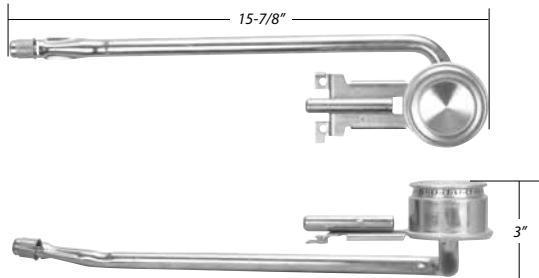

Order No. ER74003299

FRONT

Replacement  
for Whirlpool  
Also fits:  
Harper Wyman  
#2908G0081

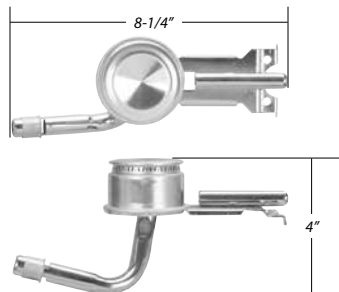

REAR

Order No. ER74003300

Replacement  
for Whirlpool  
Also fits:  
Harper Wyman  
#2908G0082

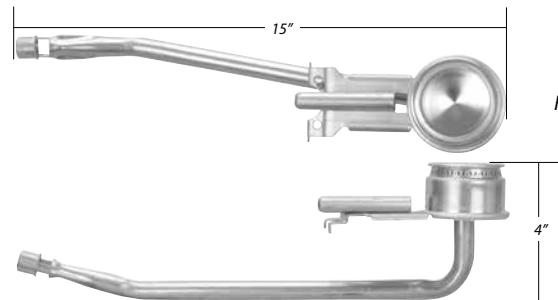

\* SEE PAGE 42 FOR BURNER ASSEMBLIES CROSS REFERENCE\*

All logos, trademarks, part numbers, photos & illustrations are intended solely for identification. Items offered for sale are not represented to be manufactured by the company that built the original equipment.

# BURNER ASSEMBLIES

Order No. ER74010145

FRONT

Replacement  
for Whirlpool

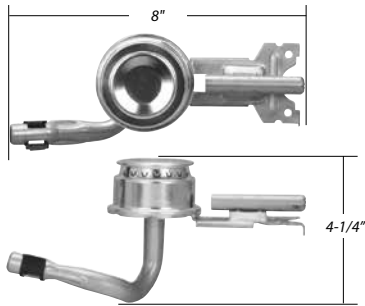

REAR

Order No. ER74010146

Replacement  
for Whirlpool

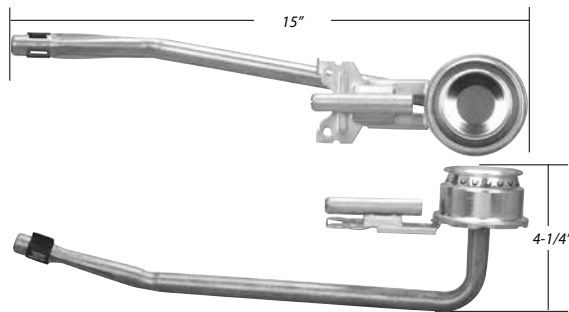

Order No. ER7505P17360

FRONT

Replacement for  
Whirlpool  
Also fits:  
GE  
#WB28X5031

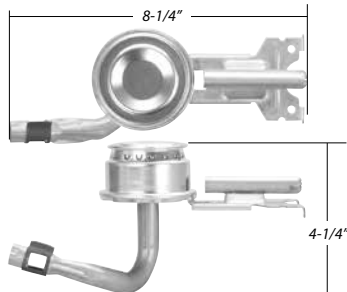

REAR

Order No. ER7505P17260

Replacement for  
Whirlpool  
Also fits:  
GE  
#WB28X5032

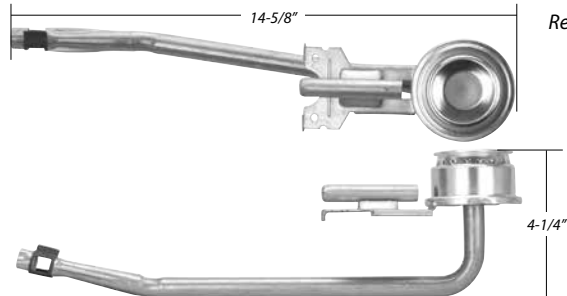

Order No. ERY0308531

FRONT

Replacement  
for Whirlpool  
Also fits:  
Harper  
Wyman  
#2908G0134  
Whirlpool  
#4363791  
#8189702

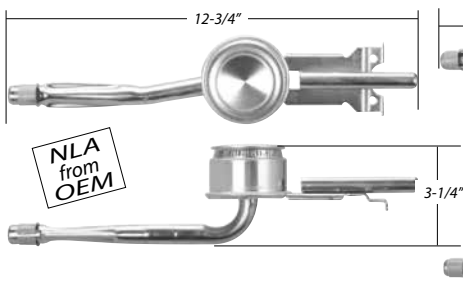

REAR

Order No. ERY0308532

Replacement  
for Whirlpool  
Also fits:  
Harper  
Wyman  
#2908G0135  
Whirlpool  
#4363792  
#8189703

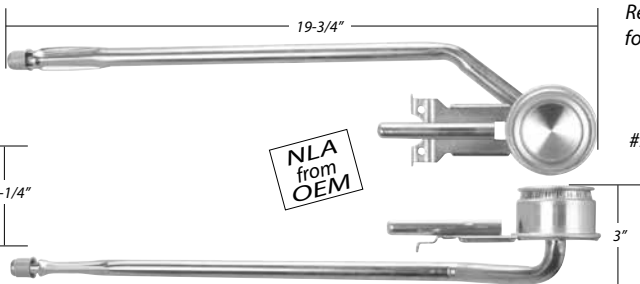

Order No. ERY07698800

FRONT

Replacement  
for Whirlpool  
Also fits:  
Harper Wyman  
#2908G0111  
Whirlpool  
#4363104

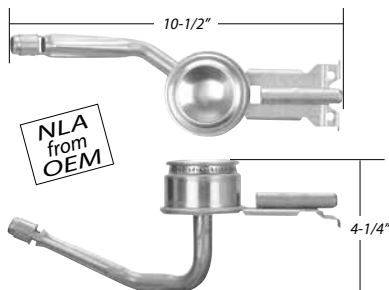

REAR

Order No. ERY07698900

Replacement  
for Whirlpool  
Also fits:  
Harper Wyman  
#2908G0112  
Whirlpool  
#4363106

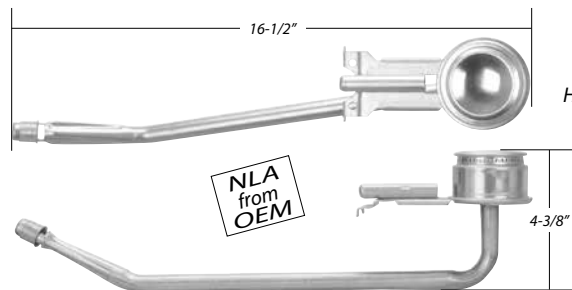

\* SEE PAGE 42 FOR BURNER ASSEMBLIES CROSS REFERENCE\*

All logos, trademarks, part numbers, photos & illustrations are intended solely for identification. Items offered for sale are not represented to be manufactured by the company that built the original equipment.

# BURNER ASSEMBLIES

Order No. ERY07699100

FRONT

Replacement for Whirlpool  
Also fits:  
Harper Wyman  
#2908G0109

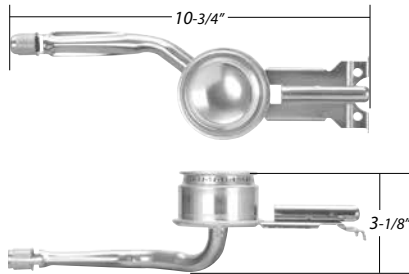

REAR

Order No. ERY07699200

Replacement for Whirlpool  
Also fits:  
Harper Wyman  
#2908G0110

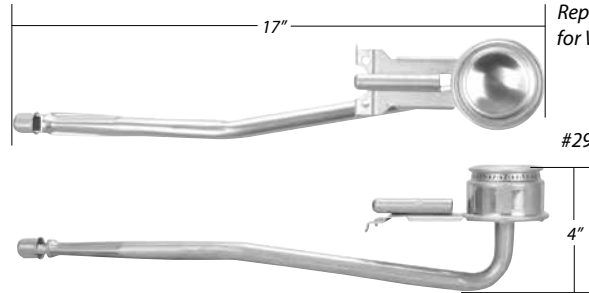

Order No. ERY07706900

FRONT

Replacement for Whirlpool  
Also fits:  
Harper Wyman  
#2908G0136

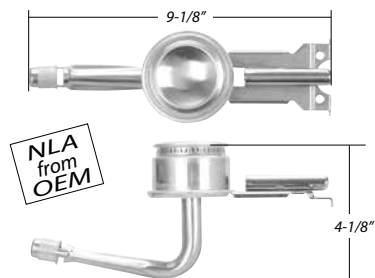

RIGHT REAR

Order No. ERY07707000

Replacement for Whirlpool  
Also fits:  
Harper Wyman  
#2908G0137

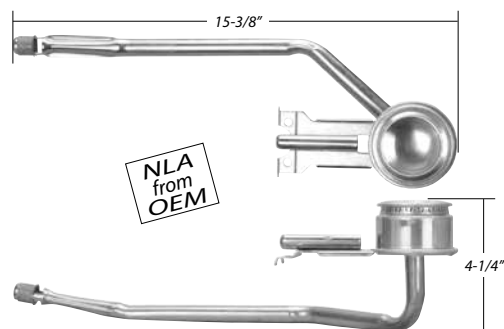

LEFT REAR

Order No. ERY07707100

Replacement for Whirlpool  
Also fits:  
Harper Wyman  
#2908G0138

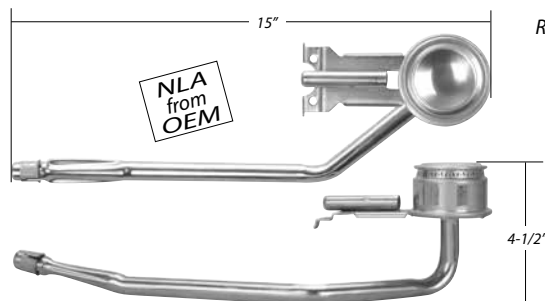

Order No. ERY07699400

FRONT

Replacement for Whirlpool  
Also fits:  
Harper Wyman  
#2908G0115

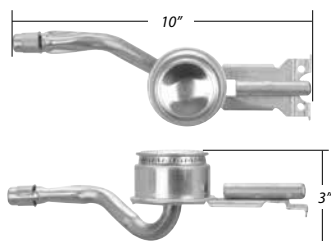

REAR

Order No. ERY07699500

Replacement for Whirlpool  
Also fits:  
Harper Wyman  
#2908G0116

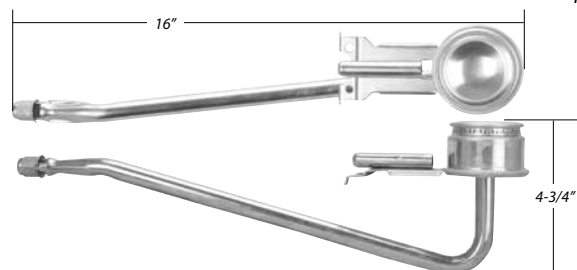

Used on Sears Kenmore models

\* SEE PAGE 42 FOR BURNER ASSEMBLIES CROSS REFERENCE\*



# BURNER ASSEMBLIES

Order No. ER18001

FRONT

Replacement  
for Slattery

NLA  
from  
OEM

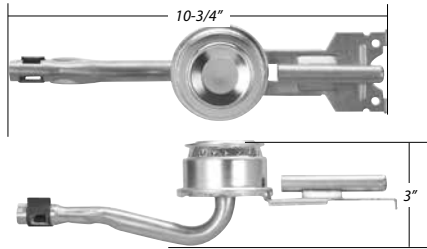

Order No. ER3412A00419

Double Burner  
Replacement for Whirlpool  
#300-254, #3412A00423

NLA  
from  
OEM



Order No. ER316057100

DOUBLE BURNER

Replacement for  
Electrolux

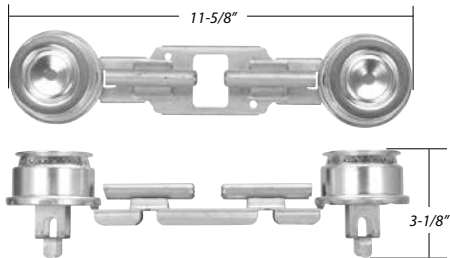

Order No. ERWB16K10003

DOUBLE BURNER

Replacement  
for GE  
Also fits:  
Harper Wyman  
#2944G0003

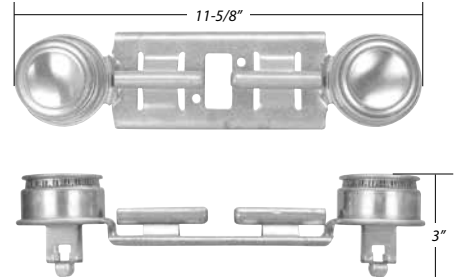

Order No. ERWB16K10026

DOUBLE BURNER

Replacement  
for GE  
Also fits:  
Harper Wyman  
#2944S0001

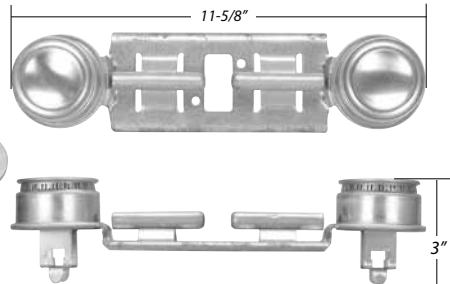

Order No. ERWB29K17

DOUBLE BURNER

Replacement  
for GE  
Also fits:  
Harper Wyman  
#2944G0004

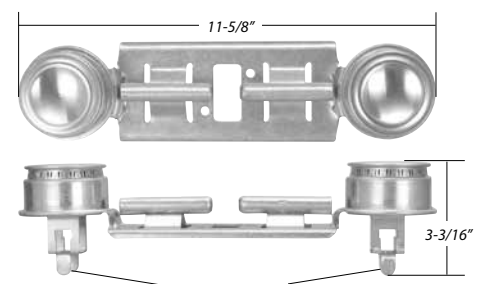

Original style had 3/16" longer supports than current production burner

Order No. ER74003332

DOUBLE BURNER

Replacement for Whirlpool Also fits: Harper Wyman #2945G0001

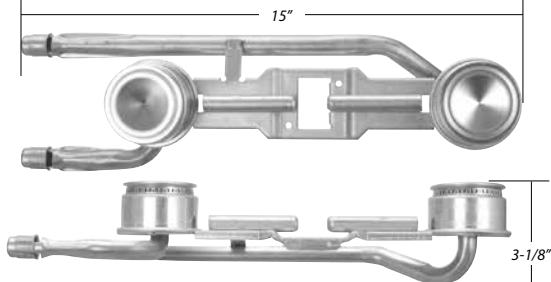

Order No. ERW10119798

DOUBLE BURNER

Replacement for Whirlpool Also fits: Harper Wyman #2945G0004



\* SEE PAGE 42 FOR BURNER ASSEMBLIES CROSS REFERENCE\*

All logos, trademarks, part numbers, photos & illustrations are intended solely for identification. Items offered for sale are not represented to be manufactured by the company that built the original equipment.

# BURNER ASSEMBLIES

**Order No. ER1801M71**

Burner Cap  
Replacement for Brown



**Order No. ER5303935025**

Burner Base Assembly  
Replacement for Electrolux

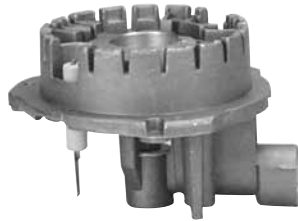

**Order No. ER74003963**

Sealed Burner  
Black porcelain  
Includes spark igniter  
Replacement for  
Whirlpool  
#12500050  
#74003963  
#3412D024-09



**Order No. ER98007369**

Top Burner  
Black porcelain  
Replacement for Whirlpool



**Order No. ER98004410**

Top Burner  
Replacement for Whirlpool



**Order No. ER98017537**

Top Burner  
Replacement for Whirlpool



**Order No. ER316213500**

Burner Cap  
2-5/8" diameter  
Black porcelain  
Replacement  
for Electrolux



**Order No. ER316213501**

Burner Cap  
2-5/8" diameter  
Gray porcelain  
Replacement  
for Electrolux



**Order No. ER3191731**

Burner Cap  
2-5/8" diameter  
Black porcelain  
Replacement for  
Whirlpool



**Order No. ER3191901**

Burner Cap  
2-3/4" diameter  
Black porcelain  
Replacement  
for Whirlpool



**Order No. ER3191903**

Burner Cap  
2-3/4" diameter  
Gray porcelain  
Replacement  
for Whirlpool

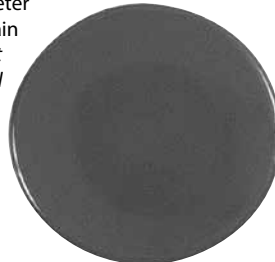

**Order No. ER98005518**

Burner Cap  
3-1/8" diameter  
Black porcelain  
Replacement for  
Whirlpool



\* SEE PAGE 42 FOR BURNER ASSEMBLIES CROSS REFERENCE\*

All logos, trademarks, part numbers, photos & illustrations are intended solely for identification. Items offered for sale are not represented to be manufactured by the company that built the original equipment.

# BURNER ASSEMBLIES

## Burner Assembly Cross Reference

OEM Part #	ERP #	PG
<b>BROWN</b>		
1801M53	ER1801M53	34
1801M54	ER1801M54	34
1801M58	ER1801M58	34
1801M59	ER1801M59	34
1801M71	ER1801M71	41
<b>ELECTROLUX</b>		
316039002	ER316039002	34
316039003	ER316039003	34
316057100	ER316057100	40
316103800	ER316103800	34
316103801	ER316103801	34
316213500	ER316213500	41
316213501	ER316213501	41
5303131079	ER5303131079	35
5303131080	ER5303131080	35
5303204154	ER5303204154	35
5303204155	ER5303204155	35
5303297990*	ER1801M53	34
5303297991*	ER1801M54	34
5303311551	ER5303131080	35
5303935025	ER5303935025	41
<b>GE/HOTPOINT</b>		
WB16K10003	ERWB16K10003	40
WB16K10026	ERWB16K10026	40
WB28X111	ERWB28X111	35
WB28X112	ERWB28X112	35
WB28X5027*	ER07519400	36
WB28X5028*	ER0052750	36
WB28X5031*	ER7505P17360	38
WB28X5032*	ER7505P17260	38
WB28X5034	ER5303204154	35
WB28X5035	ER5303204155	35
WB28X5047	ER1801M53	34

OEM Part #	ERP #	PG
WB28X5049	ER1801M54	34
WB29K17	ERWB29K17	40
<b>HARPER WYMAN</b>		
2907G0003	ER1398	35
2907G0004	ER1399	35
2907G0005	ER1404	36
2907G0006	ER1405	36
2908G0001	ER1801M53	34
2908G0002	ER1801M54	34
2908G0036	ERWB28X112	35
2908G0037	ERWB28X111	35
2908G0081	ER74003299	37
2908G0082	ER74003300	37
2908G0104	ER4335161	37
2908G0109	ERY07699100	39
2908G0110	ERY07699200	39
2908G0111	ERY07698800	38
2908G0112	ERY07698900	38
2908G0115	ERY07699400	39
2908G0116	ERY07699500	39
2908G0134	ERY0308531	38
2908G0135	ERY0308532	38
2908G0136	ERY07706900	39
2908G0137	ERY07707000	39
2908G0138	ERY07707100	39
2944G0003	ERWB16K10003	40
2944G0004	ERWB29K17	40
2944S0001	ERWB16K10026	40
2945G0001	ER74003332	40
2945G0004	ERW10119798	40
<b>MAYTAG See Whirlpool</b>		
<b>PEERLESS</b>		
1398	ER1398	35
1399	ER1399	35

OEM Part #	ERP #	PG
1404	ER1404	36
1405	ER1405	36
<b>ROPER See Whirlpool</b>		
<b>SLATTERY</b>		
18001*	ER18001	40
18007*	ER18007	36
18008*	ER18008	36
18009*	ER18009	36
<b>WHIRLPOOL</b>		
0087028*	ERY07699100	39
12500050	ER74003963	41
327075*	ER4335161	37
333222*	ERWB28X112	35
333223*	ERWB28X111	35
342551*	ERWB28X111	35
342552*	ERWB28X112	35
3186209	ER3186209	37
3186213	ER3186213	37
3186214	ER3186214	37
3186215	ER3186215	37
3191731	ER3191731	41
3191901	ER3191901	41
3191903	ER3191903	41
4335161*	ER4335161	37
4342874*	ERWB28X111	35
4342875*	ERWB28X112	35
4363104*	ERY07698800	38
4363106*	ERY07698900	38
4363791*	ERY0308531	38
4363792*	ERY0308532	38
4371480*	ER316039002	34
4371481*	ER316039003	34
74003299	ER74003299	37
74003300	ER74003300	37

OEM Part #	ERP #	PG
74003332	ER74003332	40
74003963	ER74003963	41
74010145	ER74010145	38
74010146	ER74010146	38
3412A004-19*	ER3412A00419	40
3412A024-09	ER74003963	41
7505P172-60*	ER7505P17260	38
7505P173-60	ER7505P17360	38
8187903*	ERY0308532	38
8189702*	ERY0308531	38
98005518	ER98005518	41
98007369	ER98007369	41
W10119798	ERW10119798	40
Y0052750*	ER0052750	36
Y0087029*	ERY07699200	39
Y0308531*	ERY0308531	38
Y0308532*	ERY0308532	38
Y07519400*	ER07519400	36
Y07698800*	ERY07698800	38
Y07698900*	ERY07698900	38
Y07699100	ERY07699100	39
Y07699200	ERY07699200	39
Y07699400*	ERY07699400	39
Y07699500*	ERY07699500	39
Y07706900*	ERY07706900	39
Y07707000*	ERY07707000	39
Y07707100*	ERY07707100	39

\* Burner is NLA from OEM - still available at ERP

For up-to-date cross reference, go to [www.erparts.com](http://www.erparts.com)

# TOP BURNER SPARK IGNITERS

Order No. ER308034E0136 36" lead wire  
 Order No. ER308034E0148 48" lead wire  
 Order No. ER308034E0158 58" lead wire

Has .110" female terminal attached



Order No. ER308035E0160

60" lead wire with  
 .110" female terminal attached



Order No. ER308150F0246

46" lead wire with  
 .110" female terminal attached  
 Includes spark strap

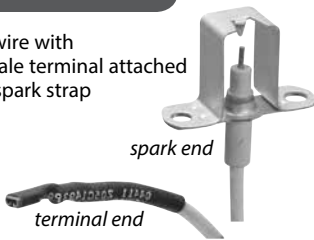

Order No. ER308150F0429

29" lead wire with  
 .187" female terminal attached  
 Includes spark strap



Order No. ER308196E0120 20" lead wire  
 Order No. ER308196E0166 66" lead wire

Has .110" female  
 terminal attached

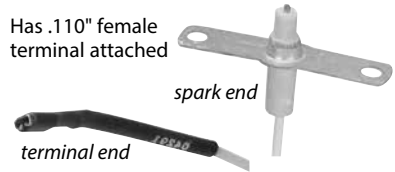

Order No. ER730110

50" lead wire with  
 .110" female terminal  
 attached

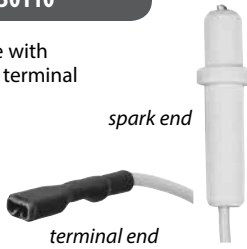

Order No. ER316081701

50" lead wire with  
 1/4" female spade terminal  
 Includes spark strap

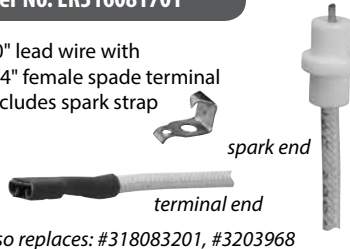

Also replaces: #318083201, #3203968

Order No. ER316081705

50" lead wire with  
 .110" female terminal  
 Includes spark strap

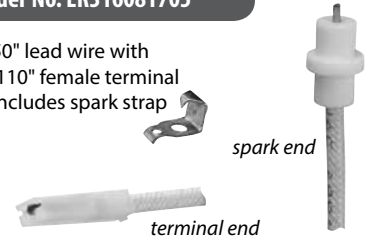

Order No. ER98014514

25-3/4" lead wire with  
 .110" female terminal end



Order No. ER308272E01

Used on sealed top burners  
 .110" female terminal attached



Order No. ERW10209656

29-1/2" lead wire with  
 .110" female terminal end

**NEW!**



Order No. ER1801B145

Spark strap



Order No. ER308125A01

Spark strap



Order No. ER308171A01

Spark strap



COOKING

# TOP BURNER SPARK IGNITERS

## Top Burner Spark Igniter Cross Reference

OEM Part #	ERP #
<b>BROWN</b>	
1801B111	ER308035E0160
1801B112	ER308035E0160
1801B116	ER308035E0160
1801B134*	ER730110
1801B135*	ER730110
1801B136*	ER730110
1801B140	ER308125A01
1801B145	ER1801B145
1801B163	ER308196E0166
1801B164	ER308196E0166
1801B166	ER308196E0166
1801B176	ER308196E0120
<b>DACOR</b>	
82592*	ER308035E0160
82545	ER308035E0160
<b>ELECTROLUX</b>	
316081701	ER316081701
316081705	ER316081705
318083200*	ER316081701
318083201	ER316081701
3203968	ER316081701
3200276*	ER316081701
3203971*	ER316081701
5301321435*	ER308034E0148
5303012879	ER730110
5303206942*	ER316081701
5303285777*	ER308125A01

OEM Part #	ERP #
5303285779	ER308196E0166
5303285780*	ER308196E0166
5308007996*	ER308034E0148
5308007997*	ER308034E0148
<b>GE/HOTPOINT</b>	
WB2X10155*	ER308035E0160
WB2X7333*	ER730110
WB2X7334*	ER730110
WB2X7335*	ER1801B145
WB2X9003	ER308125A01
WB2X9005	ER308034E0148
WB13M7*	ER308034E0148
WB19K2	ER308150F0246
WB19K20	ER308150F0429
WB21X5350	ER308196E0166
WB21X5352	ER308196E0166
WB27X10695	ER308150F0246
<b>MAYTAG <i>See Whirlpool</i></b>	
<b>PEERLESS</b>	
1474	ER308034E0136
1475	ER308034E0158
1488	ER308171A01
<b>SLATTERY</b>	
27003*	ER308035E0160
27004*	ER308035E0160
27007*	ER308035E0160
27041*	ER730110
27042*	ER730110

OEM Part #	ERP #
<b>WHIRLPOOL</b>	
0057361*	ER308034E0148
0087735*	ER308034E0158
07491600*	ER1801B145
279264	ER308034E0148
312453*	ER308125A01
329462*	ER308034E0158
329464*	ER308034E0148
339582*	ER308034E0158
340051*	ER308034E0148
342819*	ER308034E0148
4157795*	ER730110
4331307*	ER308125A01
4331308	ER308034E0148
4337231	ER308034E0148
4343157	ER308034E0148
4349396*	ER308125A01
4364150	ER308171A01
71002724	ER308272E01
7432P10960	ER308272E01
98014514	ER98014514
W10209656	ERW10209656
Y0312158*	ER308171A01
Y07491200	ER730110
Y07491203	ER730110

\* Top burner igniter is NLA from OEM - still available at ERP

For up-to-date cross reference, go to [www.erparts.com](http://www.erparts.com)



# SPARK MODULES

## Order No. ERSM20

2+0 UNIVERSAL  
2 manual circuits for top burner ignition & no oven ignition circuit

**UNIVERSAL  
3 in 1 terminal  
design**

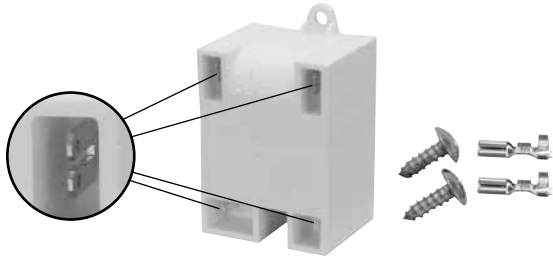

Replaces any .110", .187" and .250" output terminal sizes

## Order No. ERSM21D

2+1 UNIVERSAL  
2 manual circuits for top burner ignition & 1 flame sensing circuit for automatic oven reignition

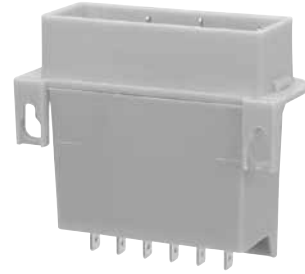

Replacement for Apco, Derlite, Harper Wyman, Invensys, Kigass, and RV 2+1 modules

Also fits:  
Brown 1801B142, GE WB20X93, Peerless 2353, Slattery 27040, Whirlpool 31829401, 4363560, R0703584

## Order No. ERSM27

2+0 UNIVERSAL  
2 manual circuits for top burner ignition & no oven ignition circuit

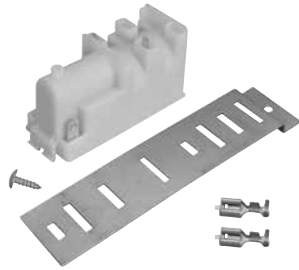

Replaces any .187" output terminal module

## Order No. ERSM40

4+0 UNIVERSAL  
4 manual circuits for top burner ignition & no oven ignition circuit  
Mounting bracket included



Replaces any .110" output terminal module

## Order No. ERSM47

4+0 UNIVERSAL  
4 manual circuits for top burner ignition & no oven ignition circuit

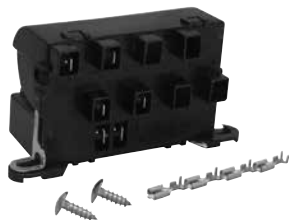

Replaces any .187" output terminal module

## Order No. ER1801B178

2+0  
2 manual circuits for top burner ignition & no oven ignition circuit

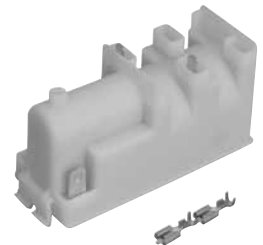

Also fits Brown #1801B178  
Invensys #07720-15, #U-67320-10

## Order No. ER1801B183

4+0  
4 manual circuits for top burner ignition & no oven ignition circuit

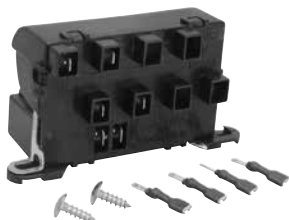

Also fits Brown #1801B183  
Invensys #46347071, #46328041

## Order No. ER1801B184

2+0  
2 manual circuits for top burner ignition & no oven ignition circuit



Also fits Brown #1801B184  
Invensys #26347071, #26328041-001

# SPARK MODULES

## Order No. ER316135702

4+0  
4 manual circuits for top burner ignition & no oven ignition circuit

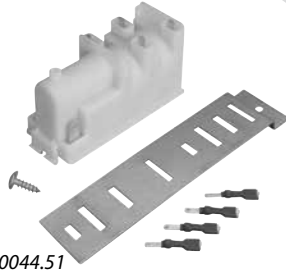

Also fits Electrolux #316135702  
ITW Ispra Controls #BK50044.51, #BK80044.51

## Order No. ER5303912606

2+0  
2 manual circuits for top burner ignition & no oven ignition circuit



Replaces Invensys #Y54052KIT

## Order No. ERWB02X10980

4+0  
4 manual circuits for top burner ignition & no oven ignition circuit

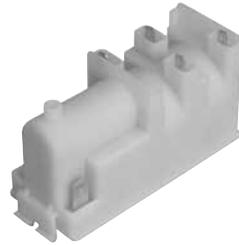

Also fits GE #WB02X10980  
Invensys #07740-055

## Order No. ERWB13K10017

2+0  
2 manual circuits for top burner ignition & no oven ignition circuit



Also fits GE #223C4319P001,  
#WB13K10017, Invensys #26347041

## Order No. ERWB13K10018

4+0  
4 manual circuits for top burner ignition & no oven ignition circuit

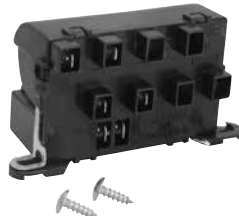

Also fits GE #223C4319P002,  
#WB13K10018, Invensys #46347041

## Order No. ERWB13K10028

2+0  
2 manual circuits for top burner ignition & no oven ignition circuit

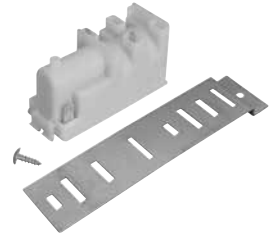

Also fits GE #WB13K10028  
Invensys #07720-15  
ITW Ispra Controls #BK80024-56, #223C4955P001

## Order No. ERWB13K10029

4+0  
4 manual circuits for top burner ignition & no oven ignition circuit

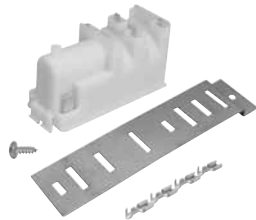

Also fits GE #WB13K10029  
Invensys #07740-055  
ITW Ispra Controls #BK80044-56, #223C4955P002

## Order No. ER6513S0001

2+1  
2 manual circuits for top burner ignition & 1 flame sensing circuit for automatic oven reignition



## Order No. ER6520G0601

2+0  
2 manual circuits for top burner ignition & no oven reignition circuit  
Contains:  
2 each .187" output terminals  
2 each .250" power input terminals



## Order No. ER6520S0201

2+0  
2 manual circuits for top burner ignition & no oven ignition circuit

Universal split terminal design suitable for .110", .187" & .250" push on wiring

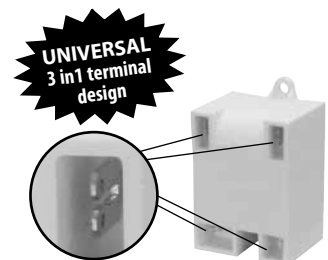

# SPARK MODULES

## Order No. ER6540S0001

0+4  
No manual circuits for top burner ignition, all 4 top burner circuits are individual flame sensing for automatic top burner reignition



## Order No. ER6542S0001

4+0  
4 manual circuits for top burner ignition & no oven ignition circuit  
Mounting bracket included



## Order No. ER6544S0001

4+0  
4 manual circuits for top burner ignition & no oven ignition circuit  
Snap in mounting



## Order No. ER6545S0001

2+0  
2 manual circuits for top burner ignition & no oven ignition circuit  
Snap in mounting



## Order No. ER6547S0001

4+1  
4 manual circuits for top burner ignition & 1 flame sensing circuit for automatic oven reignition



Also fits: Brown #1801B179, Peerless #2356, Whirlpool #31829601, #R0703585

## Order No. ER6548S0001

3+1  
3 manual circuits for top burner ignition & 1 flame sensing circuit for automatic oven reignition



Also fits: Peerless #2351, #2358, Whirlpool #1522103, #4364410, #R0703583

## Order No. ER6549S0001

2+1  
2 manual circuits for top burner ignition & 1 flame sensing circuit for automatic oven reignition



## Order No. ERAT413

0+1  
No manual for top burner circuit & 1 flame sensing circuit for automatic reignition



Also fits Invensys #41-521 (SM2)

## Order No. ER12001594

2+0  
2 manual circuits for top burner ignition & no oven ignition circuit

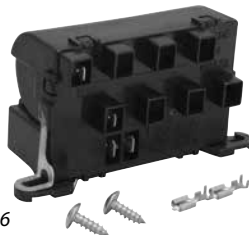

Also fits Invensys #26347071, U-67320-96  
Whirlpool #12001594, #7431P043-60

## Order No. ER12001596

4+0  
4 manual circuits for top burner ignition & no oven ignition circuit

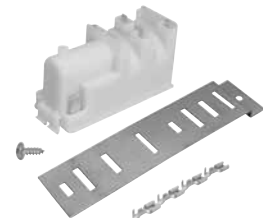

Also fits Capable Controls #4001LG187  
Invensys #07740-055, U-67340-92  
Whirlpool #12001596, #7431P02-76,  
#7431P044-60, #74003288

# SPARK MODULES

## Order No. ER3186576

4+0  
4 manual circuits for top burner ignition & no oven ignition circuit

Also fits Invensys #07740-075,  
#U-67340-11  
Whirlpool #3186576

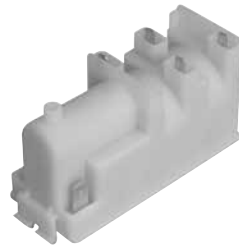

## Order No. ER31962701

4+0  
4 manual circuits for top burner ignition & no oven ignition circuit

Also fits Invensys #07740-075  
Whirlpool #31962701

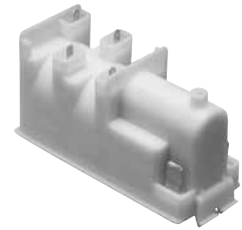

## Order No. ER32020101

4+0  
4 manual circuits for top burner ignition & no oven ignition circuit

Also fits Apco/Kigass #D8653/3  
Invensys #Y644500, #07740-075  
Whirlpool #32020101, #7431P016-60

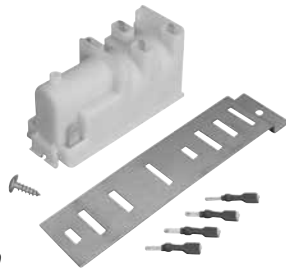

## Order No. ER6610341

4+0  
4 manual circuits for top burner ignition & no oven ignition circuit

Also fits ITW Ispra Controls # BF-50044-55,  
Whirlpool #6610341



## Order No. ER74004282

2+0  
2 manual circuits for top burner ignition & no oven ignition circuit

Also fits Whirlpool #7431P036-60,  
#7431P055-60, Invensys #26347071



## Order No. ER74004283

4+0  
4 manual circuits for top burner ignition & no oven ignition circuit

Also fits Whirlpool #74004283

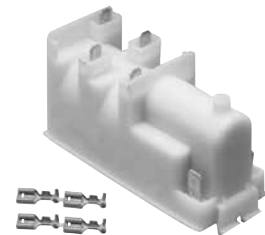

## Order No. ER74008821

4+0  
4 manual circuits for top burner ignition & no oven ignition circuit

Also fits Invensys #46347071  
Whirlpool #7431P054-60, #74008821

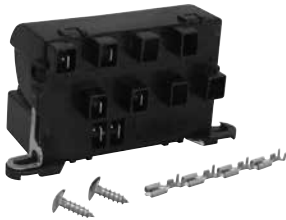

## Order No. ER7431P043-60

2+0  
2 manual circuits for top burner ignition & no oven ignition circuit

Also fits Invensys #07720-15, #U-67320-96  
Whirlpool #7431P043-60

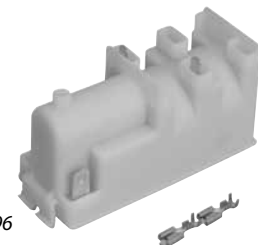

## Order No. ER7431P2760 *no bracket*

Also fits #32020101, #U67340-11,  
#Y0315549, #Y64450-01

## Order No. ER7431P2760K *with bracket*

Also fits #12001596

4+0  
4 manual circuits for top burner ignition & no oven ignition circuit  
Snap-in mounting .110" output terminals

Replacement for Whirlpool

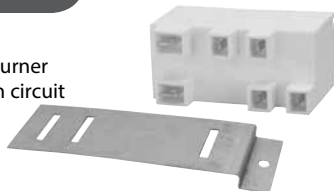

## Order No. ER8053421

4+0  
4 manual circuits for top burner ignition & no oven ignition circuit

Also fits Invensys #07740-045, #U-67340-40  
Whirlpool #8053421

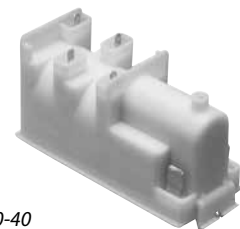

# SPARK MODULES

## Order No. ER8215557

4+0  
4 manual circuits for top burner ignition & no oven ignition circuit

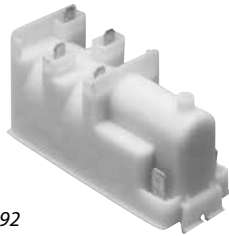

Also fits Invensys #07740-055, #U-67340-92  
Whirlpool #7431P044-60, #8215557, #74004283

## Order No. ERW10162890

2+0  
2 manual circuits for top burner ignition & no oven ignition circuit



Also fits Invensys #26347071  
Whirlpool #7431P055-60, #W10162890

## Order No. ERW10331686

**NEW!**  
Enhanced Electronic Spark Module Circuit Board  
This new board has diagnostic capabilities to help diagnose problems that may occur in your range. The LED light on your new board will blink different codes should a problem occur. The meaning of these codes are printed on your new board.

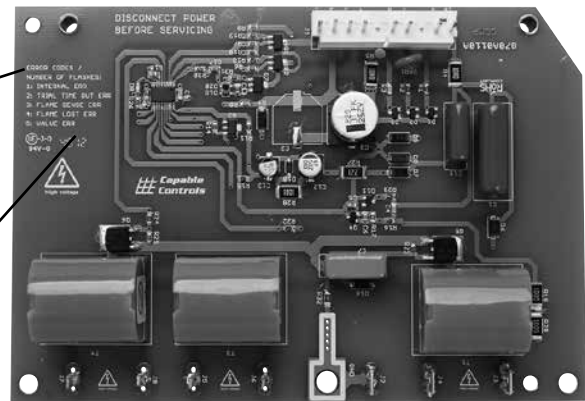
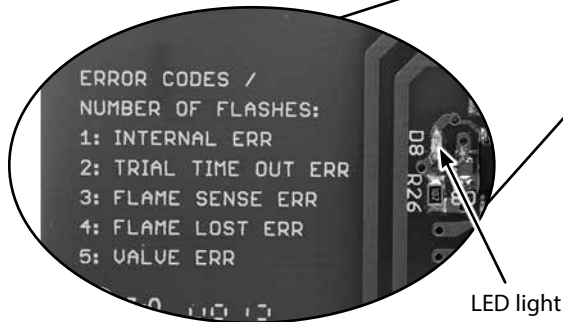

Also fits Whirlpool #9758080, #W10331686

## Spark Module Cross Reference

OEM Part #	ERP #	ERP Kit#
<b>APCO See Derlite</b>		
<b>BLODGETT</b>		
18346	ERAT413	×
21080	ERAT413	×
<b>BROWN</b>		
1801B105	ER6513S0001	×
1801B121*	ER6548S0001	×
1801B122	ER6520S0201	ERSM20
1801B131*	ER6548S0001	×
1801B142*	ERSM21D	×
1801B161*	ER6542S0001	ERSM40
1801B173	ER6549S0001	×
1801B174*	ER6540S0001	×

OEM Part #	ERP #	ERP Kit#
1801B177*	ER6520S0201	ERSM20
1801B178*	ER6520S0201	ERSM20
1801B179	ER6547S0001	×
1801B183	ER1801B183	ERSM40
1801B184	ER1801B184	ERSM20
<b>CAPABLE CONTROLS</b>		
4001	ER7431P02760	ERSM40
<b>DACOR</b>		
82487*	ER6520S0201	ERSM20
82591*	ER6542S0001	ERSM40
<b>DERLITE</b>		
18087/A	ERSM21D	×
19100	ER6547S0001	×

OEM Part #	ERP #	ERP Kit#
7087	ERSM21D	×
D8653/3	ERSM40	ERSM40
DG189	ERSM21D	×
<b>DUKE</b>		
153981	ERAT413	×
<b>ELECTROLUX</b>		
08008047	ER6542S0001	ERSM40
316135700	ERSM20	ERSM20
316135701*	ERSM40	ERSM40
316135702	×	ER316135702
5303200332	ER6513S0001	×
5303200669*	ER6520S0201	ERSM20
5303912606	ER5303912606	ERSM20

\* Spark module is NLA from OEM - still available at ERP

For up-to-date cross reference, go to [www.erparts.com](http://www.erparts.com)



# SPARK MODULES

## Spark Module Cross Reference

OEM Part #	ERP #	ERP Kit#
5304404913	ER6549S0001	✗
5304408629*	ER6548S0001	✗
5308016487*	ER6548S0001	✗
<b>GARLAND</b>		
077188-1	ERAT413	✗
1592800	ER6540S0001	✗
1592900	ER6542S0001	ERSM40
<b>GE/ HOTPOINT</b>		
205C1245P001	ER6520S0201	ERSM20
205C1245P002	ER6520S0201	ERSM20
205C1245P003	ER6520G0601	✗
205C1245P004	ER6520G0601	✗
205C1861P001	ER6542S0001	ERSM40
205C1861P002	ERSM47	ERSM47
205C1862P002	ER6542S0001	ERSM40
205C1910P001	ER6540S0001	✗
223C3200P001	ER6545S0001	ERSM20
223C3200P002	ER6545S0001	ERSM20
223C3201P001	ER6544S0001	ERSM47
223C3201P002	ER6544S0001	ERSM47
223C4319P001	ERWB13K10017	✗
223C4319P002	ERWB13K10018	✗
223C4955P001	ERWB13K10028	ERSM20
223C4955P002	ERWB13K10029	ERSM47
WB02X10980	ERWB02X10980	ERSM47
WB13K10*	ER6520G0601	✗
WB13K10017	ERWB13K10017	✗
WB13K10018	ERWB13K10018	✗
WB13K10028	ERWB13K10028	ERSM20
WB13K10029	ERWB13K10029	ERSM47
WB13K25	ER6544S0001	ERSM47
WB13K5*	ER6542S0001	ERSM40
WB13K5052*	ER6542S0001	ERSM40
WB20K5037	ER6545S0001	ERSM20
WB13K5046	ER6540S0001	✗
WB13K6*	ER6540S0001	✗
WB13K7*	ER6520S0201	ERSM20
WB13K8*	ER6542S0001	ERSM40
WB20X10010	ER6549S0001	✗
WB20X104*	ER6513S0001	✗
WB20X107	ER6520S0201	ERSM20

OEM Part #	ERP #	ERP Kit#
WB20X120*	ER6542S0001	ERSM40
WB20X131	ER5303912606	ERSM20
WB20X138	ER6540S0001	✗
WB20X93*	ERSM21D	✗
WB21X5265	ER6520S0201	ERSM20
WB49X10192	ER6549S0001	✗
<b>HARPER WYMAN</b>		
6508G00XX	ER6520S0201	ERSM20
6511G00XX	ER6520S0201	ERSM20
6513G00XX	ER6513S0001	✗
6514G00XX	ER6548S0001	✗
6520G00XX	ER6520S0201	ERSM20
6520G02XX	ER6520S0201	ERSM20
6520G03XX	ER6520S0201	ERSM20
6540G00XX	ER6540S0001	✗
6542G00XX	ER6542S0001	ERSM40
6544G10XX	ER6544S0001	ERSM47
6545G10XX	ER6545S0001	ERSM20
6547G10XX	ER6547S0001	✗
6548G00XX	ER6548S0001	✗
6549G10XX	ER6549S0001	✗
<b>IMPERIAL</b>		
0518	ERAT413	✗
<b>INVENSYS CONTROLS</b>		
07720-015	✗	ERSM20
07720-035	ER6520S0201	ERSM20
07720-0XX	ER6520S0201	ERSM20
07740-015	ER31962701	ERSM40
07740-045	ER8053421	ERSM40
07740-055	ER8215557	ERSM47
07740-075	ER31962701	ERSM40
07740-095	ER12001596	ERSM47
07740-105	ER12001596	ERSM47
07740-XXX	ER12001596	ERSM47
26328041	ER1801B184	ERSM20
26347041	ERWB13K10017	✗
26347071	ER74004282	ERSM20
46328041	ER1801B183	ERSM40
46347041	ERWB13K10018	✗
46347071	ER74008821	ERSM47
41-501	ER31962701	ERSM40

OEM Part #	ERP #	ERP Kit#
41-520	ER6520S0201	ERSM20
41-521	ERAT413	✗
SM	ER6520S0201	ERSM20
SM1	ER6520S0201	ERSM20
SM2	ERAT413	✗
U-67201-20	ER6513S0001	✗
U-67204-01	ER6540S0001	✗
U-67320-10	ER6520S0201	ERSM20
U-67320-96	✗	ERSM20
U-67320-XX	ER6520S0201	ERSM20
U-67340-11	ER31962701	ERSM40
U-67340-40	ER8053421	ERSM40
U-67340-92	ER8215557	ERSM47
Y-54052-10	ER5303912606	ERSM20
Y-54052-50	ER6520S0201	ERSM20
Y-54052-KIT	ER5303912606	ERSM20
Y-54052-XX	ER6520S0201	ERSM20
Y-56853-1AF	ER6513S0001	✗
Y-64450-0	ER7431P02760	ERSM40
Y-64450-01	ER7431P02760	ERSM40
Y-64450-14	ER3186576	ERSM40
<b>ITW ISPRA CONTROLS</b>		
1401B	ER6520S0201	ERSM20
1401S	ER6520S0201	ERSM20
2001S	ER6520S0201	ERSM20
BF-50044-55	ER6610341	ERSM40
BK-50024-51	ER6520S0201	ERSM20
BK-50024-XX	ER6520S0201	ERSM20
BK-50044-51	ER316135702	ERSM40
BK-80024-56	ERWB13K10028	ERSM20
BK-80024-XX	ER6520S0201	ERSM20
BK-80044-51	ER316135702	ERSM40
BK-80044-56	ERWB13K10029	ERSM47
<b>JADE</b>		
460-161-000	ERAT413	✗
<b>KEATING</b>		
28620	ERAT413	✗
<b>KIGASS See Derlite</b>		
<b>LANG</b>		
80300-03	ERAT413	✗
<b>MAYTAG See Whirlpool</b>		

\* Spark module is NLA from OEM - still available at ERP

For up-to-date cross reference, go to [www.erparts.com](http://www.erparts.com)

# SPARK MODULES

## Spark Module Cross Reference

OEM Part #	ERP #	ERP Kit#
<b>PEERLESS</b>		
2350	ER6513S0001	✗
2351	ER6548S0001	✗
2353	ERSM21D	✗
2356	ER6547S0001	✗
2357	ER6549S0001	✗
2358	ER6548S0001	✗
<b>PRIZER PAINTER</b>		
701701	ER6540S0001	✗
P0000800	ER6520S0201	ERSM20
P0000900	ER6542S0001	ERSM40
<b>ROBERTSHAW <i>See Invensys</i></b>		
<b>RV ELECTRONICS</b>		
177/0017703100	ER6520S0201	ERSM20
977/0097701700	ER6513S0001	✗
977/0097700200	ER6513S0001	✗
<b>SIEBE <i>See Invensys</i></b>		
<b>SLATTERY</b>		
270-02*	ER6513S0001	✗
270-25*	ER6520S0201	ERSM20
270-40*	ERSM21D	✗
<b>SOUTHBEND</b>		
1164809	ERAT413	✗
<b>TYTRONICS</b>		
IG120J-2	ER6520S0201	ERSM20
IG120JB-2	ER6520S0201	ERSM20
<b>US RANGE</b>		
227168	ERAT413	✗
<b>VIKING</b>		
PA020008	ER6520S0201	ERSM20
PA020009	ER6542S0001	ERSM40
PA020013	ER6540S0001	✗
PA020016	ER6544S0001	ERSM40
<b>VULCAN</b>		
4148060001-1	ERAT413	✗
<b>WHIRLPOOL</b>		
12001594	ER12001594	ERSM20
12001596	ER12001596	ERSM47
1430322	ER6520S0201	ERSM20
1522103*	ER6548S0001	✗
306035*	ER5303912606	ERSM20

OEM Part #	ERP #	ERP Kit#
31829401	ERSM21D	✗
31829601	ER6547S0001	✗
318445*	ER6513S0001	✗
3185229	ER6540S0001	✗
3186576	ER3186576	ERSM40
3196023	ER6520S0201	ERSM20
31962701	ER31962701	ERSM40
32020101	ER7431P2760	ERSM40
320990*	ER6520S0201	ERSM20
321965*	ER6542S0001	ERSM40
325126*	ER6548S0001	✗
326136*	ER6513S0001	✗
340081*	ER6540S0001	✗
359259*	ER6520S0201	ERSM20
4332657*	ER6513S0001	✗
4333260*	ER6520S0201	ERSM20
4333524*	ER6542S0001	ERSM40
4334438*	ER6520S0201	ERSM20
4334453*	ER6548S0001	✗
4334842*	ER6513S0001	✗
4353301*	ER6513S0001	✗
4353695*	ER5303912606	ERSM20
4353938*	ER5303912606	ERSM20
4363454*	ER6548S0001	✗
4363560	ERSM21D	✗
4364409	ER6549S0001	✗
4364410	ER6548S0001	✗
4372836	ER5303912606	ERSM20
4389497*	ER6520S0201	ERSM20
4389821*	ER6513S0001	✗
4454392	ER6540S0001	✗
6610341	ER6610341	ERSM40
7454900	ER6513S0001	✗
7454901	ER6548S0001	✗
7454903	ER6548S0001	✗
7508120	ER6520S0201	ERSM20
71001926	ER6540S0001	✗
74003288	ER12001596	ERSM47
74004282	ER74004282	ERSM20
74004283	ER74004283	ERSM47
74008821	ER74008821	ERSM47

OEM Part #	ERP #	ERP Kit#
7431P003-60*	ER6542S0001	ERSM40
7431P004-60*	ER6542S0001	ERSM40
7431P005-60*	ER6520S0201	ERSM20
7431P008-60*	ER6520S0201	ERSM20
7431P011-60	ER6513S0001	✗
7431P016-60*	ER7431P02760	ERSM40
7431P027-60*	ER7431P02760	ERSM40
7431P028-60*	ER7431P02760	ERSM40
7431P036-60*	ER74004282	ERSM20
7431P043-60*	✗	ERSM20
7431P044-60*	ER8215557	ERSM47
7431P054-60*	ER74008821	ERSM47
7431P055-60*	ER74004282	ERSM20
7431P060-60	ER12001596	ERSM47
7431P062-60*	ER12001596	ERSM47
8053420	ER6520S0201	ERSM20
8053421	ER8053421	ERSM40
8215557	ER8215557	ERSM47
8522422	ER6520S0201	ERSM20
878006*	ER6513S0001	✗
88870*	ER6513S0001	✗
9758080	ERW10331686	✗
R0703583	ER6548S0001	✗
R0703584	ERSM21D	✗
R0703585	ER6547S0001	✗
W10162890	ERW10162890	ERSM20
W10331686	ERW10331686	✗
Y705823	ER6540S0001	✗
Y0091229*	ER6520S0201	ERSM20
Y0302244	ER6540S0001	✗
Y0305451	ER6542S0001	ERSM40
Y0314416*	ER6544S0001	ERSM40
Y0315549*	ER6542S0001	ERSM40
<b>WOLF</b>		
13931	ERAT413	✗

\* Spark module is NLA from OEM - still available at ERP

For up-to-date cross reference, go to [www.erparts.com](http://www.erparts.com)

# BURNER VALVES

## Order No. ER1801A133

90° shaft rotation - Square bolt thru mount  
Replacement for Brown

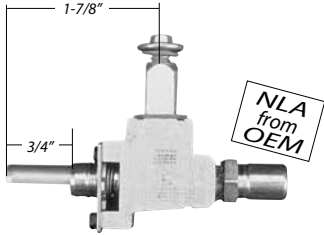

Also fits: Harper Wyman #1802M0074

NLA  
from  
OEM

## Order No. ER1801A157

90° shaft rotation - Square bolt thru mount  
Replacement for Brown

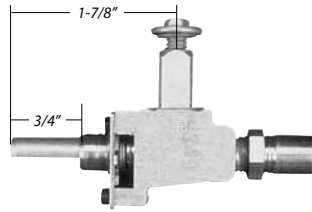

Also fits: Electrolux #5303285727, GE #WB2X5346,  
Harper Wyman #1802M0084

## Order No. ER1801A166

90° shaft rotation  
Screw in mount  
Replacement for  
Brown

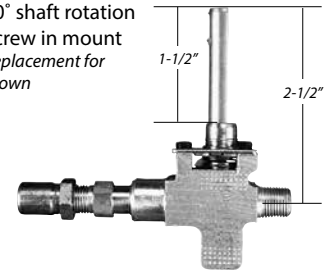

Also fits: Harper Wyman #1804G0091

## Order No. ER1801A167

90° shaft rotation  
Screw in mount  
Replacement for  
Brown

**NEW!**

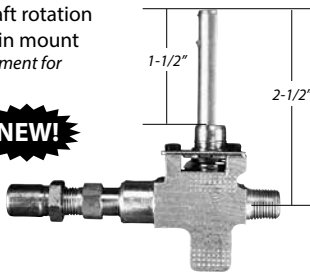

Also fits: Harper Wyman #1804G0091

## Order No. ER1801A203

Brass

270° shaft rotation  
Saddle mount  
Replacement for Brown

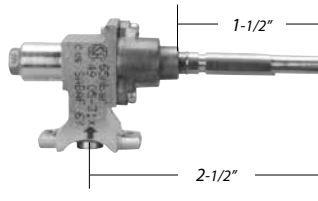

## Order No. ER318087100

Brass

200° shaft rotation  
Bolt thru mount  
Replacement for Electrolux

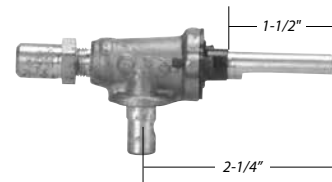

## Order No. ER5303288190

Brass

220° shaft rotation  
Screw in mount  
Hi-Med-Low  
Replacement for Electrolux

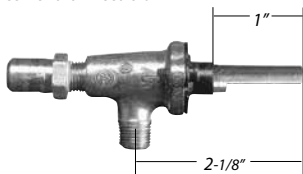

## Order No. ER5303935128

Brass

115° shaft rotation  
Bolt thru mount  
Replacement for Electrolux

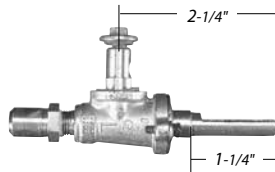

Also fits: Whirlpool #4371297

## Order No. ERWB06X10635

90° shaft rotation  
Square bolt thru mount  
Replacement for GE

**NEW!**

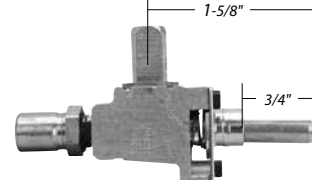

## Order No. ERWB21K4

106° shaft rotation - Square bolt thru mount  
Replacement for GE

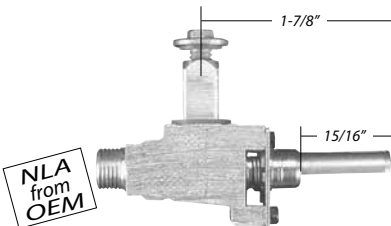

Also fits: Harper Wyman #1802M0176

NLA  
from  
OEM

## Order No. ERWB21K12

270° shaft rotation - Square bolt thru mount  
1/4" tubing outlet  
Replacement for GE

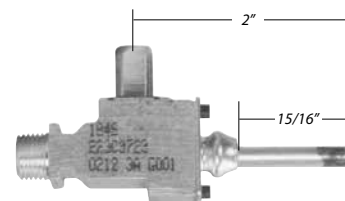

Also fits: Harper Wyman #1846R0030, GE #WB21K40

## Order No. ERWB21K19

106° shaft rotation - Screw in mount  
1/4" tubing outlet  
Replacement for GE

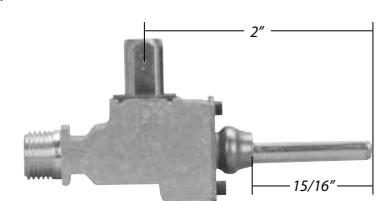

Also fits: Harper Wyman #1842R0002

# BURNER VALVES

**Order No. ERWB21K38**

140° shaft rotation - Square bolt thru mount  
1/4" tubing outlet  
Replacement for GE

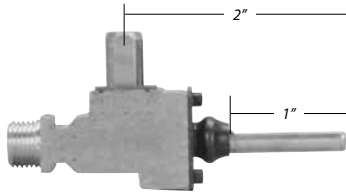

Also fits: Harper Wyman #1842R0014

**Order No. ERWB21K39**

**Brass**

140° shaft rotation  
Bolt thru mount  
1/4" tubing compression outlet  
Replacement for General Electric

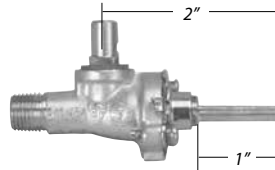

**Order No. ERWB21K10050**

**Brass**

140° shaft rotation  
Bolt thru mount  
Replacement for GE

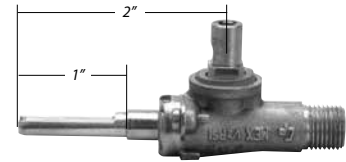

Also fits: GE #WB21K10009

**Order No. ERWB21X467**

106° shaft rotation - Square bolt thru mount  
Replacement for GE

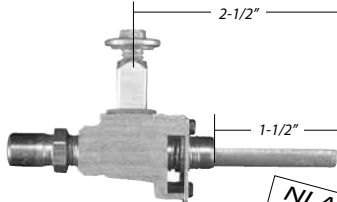

Also fits: Harper Wyman #1802M0148, Whirlpool #332001, #338853, #4342578

**NLA from OEM**

**Order No. ERWB21X473**

106° shaft rotation - Square bolt thru mount  
Replacement for GE

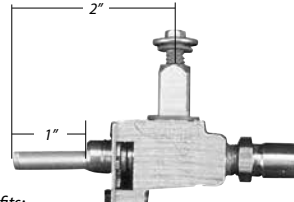

Also fits: Harper Wyman #1802M0126, Whirlpool #322816, #324987, #4332669, #4333719, #4354675

**Order No. ER1250**

106° shaft rotation - Square bolt thru mount  
Replacement for Peerless

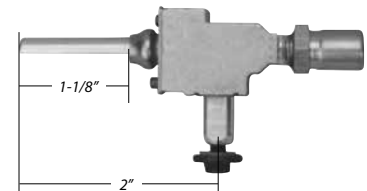

Also fits: Harper Wyman #1842R0011, Peerless #1251, Whirlpool #4364162

**Order No. ER1255**

180° shaft rotation - Screw in mount  
Replacement for Peerless

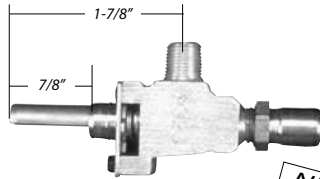

Also fits: Harper Wyman #1852G0088, Whirlpool #Y0087004, #Y0087734

**NLA from OEM**

**Order No. ER60140**

**Brass**

Universal valve  
115° shaft rotation  
Stem flat 12 o'clock  
Screw in mount  
Replacement for Peerless Premier



Also fits: Peerless Premier #1273, #60063

**Order No. ER03011**

**Brass**

90° shaft rotation  
Screw in mount  
Has roll pin installed in stem to activate spark switch slide bar  
Replacement for Slattery

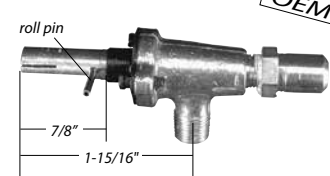

**NLA from OEM**

**Order No. ER03018**

**Brass**

90° shaft rotation  
Screw in mount  
Has roll pin installed in stem to activate spark switch slide bar  
Replacement for Slattery

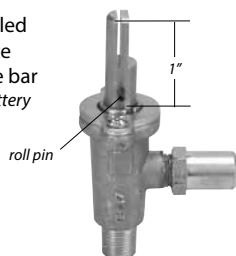

**NLA from OEM**

**Order No. ER0310245**

**Brass**

115° shaft rotation  
Screw in mount  
Replacement for Whirlpool

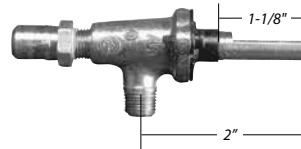

**NLA from OEM**

**Order No. ER0310647**

**Brass**

90° shaft rotation  
Screw in mount  
Replacement for Whirlpool

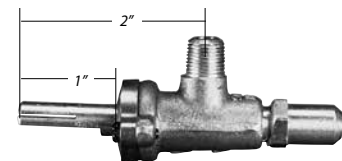

Also fits: Whirlpool #Y0310647

COOKING

# BURNER VALVES

**Order No. ER12002279**

90° shaft rotation  
Square bolt thru mount  
1/4" tubing outlet  
Replacement for Whirlpool

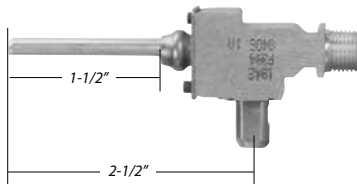

Also fits: Harper Wyman #1842R0006,  
Whirlpool #7502P27860, #7502P39460

**Order No. ER4332720**

106° shaft rotation  
Square bolt thru mount  
Replacement for  
Whirlpool

NLA  
from  
OEM

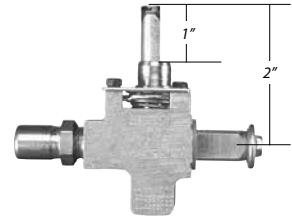

Also fits: Harper Wyman #1804M0089,  
Whirlpool #318707, #321794, #4333474

**Order No. ER7502P18760**

Brass

90° shaft rotation  
Bolt thru mount  
Replacement for Whirlpool

NLA  
from  
OEM

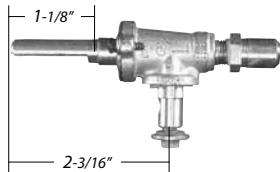

Also fits: Whirlpool #12400037

**Order No. ER8273004**

Brass

270° shaft rotation  
Bolt thru mount  
1/4" tubing  
compression outlet  
Replacement for Whirlpool

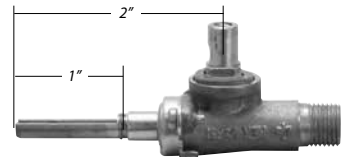

**Order No. ER9757218**

270° shaft rotation  
Bolt thru mount  
Replacement for Whirlpool

**NEW!**

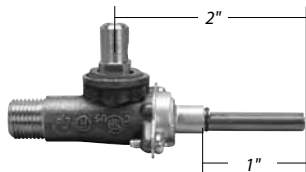

**Order No. ER98005574**

Brass

270° shaft rotation  
Bolt thru mount  
Fixed orifice spud outlet  
Replacement for Whirlpool

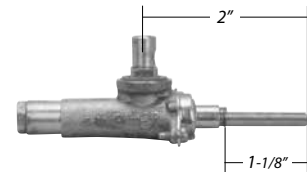

**Order No. ERY0068689**

90° shaft rotation  
Screw in mount  
Replacement for  
Whirlpool

NLA  
from  
OEM

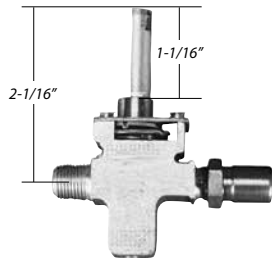

Also fits: Harper Wyman  
#1804G0057

**Order No. ERY07596101**

90° shaft rotation  
Square bolt thru mount  
Replacement for Whirlpool

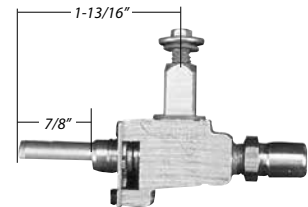

Also fits: Harper Wyman #1802M0166

**Order No. ERY07596200**

180° shaft rotation  
Square bolt thru mount  
Replacement for Whirlpool

NLA  
from  
OEM

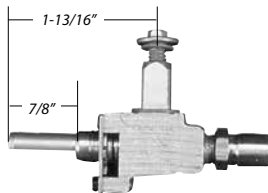

Also fits: Harper Wyman #1852M0305,  
Whirlpool #Y0057339



# BURNER VALVES

## Burner Valve Cross Reference

OEM Part #	ERP #	PG
<b>AMANA</b> <i>See Whirlpool</i>		
<b>BROWN</b>		
1801A133*	ER1801A133	52
1801A134*	ER1801A133	52
1801A157	ER1801A157	52
1801A158	ER1801A157	52
1801A166	ER1801A166	52
1801A167	ER1801A167	52
1801A203	ER1801A203	52
<b>ELECTROLUX</b>		
318087100	ER318087100	52
5303285727	ER1801A157	52
5303288190	ER5303288190	52
5303935128	ER5303935128	52
<b>GE/HOTPOINT</b>		
WB06X10635	ERWB06X10635	52
WB2X5346	ER1801A157	52
WB21K4*	ERWB21K4	52
WB21K10009	ERWB21K10050	53
WB21K10050	ERWB21K10050	53
WB21K12	ERWB21K12	52
WB21K19	ERWB21K19	52
WB21K38	ERWB21K38	53
WB21K39	ERWB21K39	53

OEM Part #	ERP #	PG
WB21X467	ERWB21X467	53
WB21X473	ERWB21X473	53
<b>MAYTAG</b> <i>See Whirlpool</i>		
<b>PEERLESS</b>		
1250	ER1250	53
1251	ER1250	53
1255*	ER1255	53
60063*	ER60140	53
60140	ER60140	53
<b>ROPER</b> <i>See Whirlpool</i>		
<b>SLATTERY</b>		
03011*	ER03011	53
03018*	ER03018	53
<b>WHIRLPOOL</b>		
0310245*	ER0310245	53
12002279	ER12002279	54
12400037*	ER7502P18760	54
318707*	ER4332720	54
321794*	ER4332720	54
322816*	ERWB21X473	53
324987*	ERWB21X473	53
332001*	ERWB21X467	53
338853	ERWB21X467	53
4332669*	ERWB21X473	53

OEM Part #	ERP #	PG
4332720*	ER4332720	54
4333474*	ER4332720	54
4333719*	ERWB21X473	53
4342578	ERWB21X467	53
4354675*	ERWB21X473	53
4354694*	ERWB21X473	53
4364162	ER1250	53
4371297	ER5303935128	52
7502P18760*	ER7502P18760	54
7502P27860*	ER12002279	54
7502P39460*	ER12002279	54
8273004	ER8273004	54
9757218	ER9757218	54
98005574	ER98005574	54
Y0057339*	ERY07596200	54
Y0068689*	ERY0068689	54
Y0087004*	ER1255	53
Y0087734*	ER1255	53
Y0310647	ER0310647	53
Y07596101	ERY07596101	54
Y07596200*	ERY07596200	54

\* Burner Valve is NLA from OEM - still available at ERP

For up-to-date cross reference, go to [www.erparts.com](http://www.erparts.com)

# SPARK SWITCHES

## Order No. ER1801A152

Pink cam  
2 side terminals  
80° make  
.340" "D" insert  
Replacement for Brown



stem flat 12



Also fits: Harper Wyman #1899G0022

## Order No. ER1801A153

Light green cam  
2 side terminals  
160° make  
.340" "D" insert  
Replacement for Brown



stem flat 12

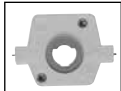

Also fits: Harper Wyman #1899G0016

## Order No. ER1801A165

Dark blue cam  
2 side terminals  
82° make  
.340" "D" insert  
Replacement for Brown



stem flat 6



Also fits: Harper Wyman #1899G0003

## Order No. ER1802A207

Oven Switch

Black cam  
25° make  
Replacement for Brown

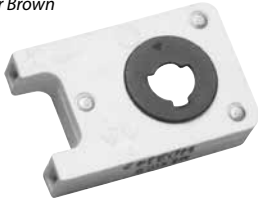

stem flat 12

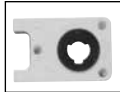

Also fits: Harper Wyman #5199G0002

## Order No. ER1802A223

Oven Switch

White cam  
25° make  
Replacement for Brown

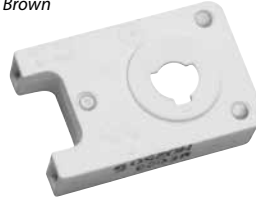

stem flat 6



Also fits: Harper Wyman #5199G0003

## Order No. ER316032000

55° make  
.340" "D" insert  
Replacement for Electrolux



stem flat 6



## Order No. ER316032001

108° make  
.340" "D" insert  
Replacement for Electrolux



stem flat 6



## Order No. ER316035200

50° make  
.340" "D" insert  
Replacement for Electrolux



stem flat 6



## Order No. ER316035201

100° make  
.340" "D" insert  
Replacement for Electrolux



stem flat 6



## Order No. ERWB13M1

.256" "D" insert  
Replacement for GE

**NEW!**



stem flat 2



## Order No. ERWB24K1

Light purple cam  
2 side terminals  
92° make  
.340" "D" insert  
Replacement for GE



stem flat 12



Also fits: Harper Wyman #1899G0043

## Order No. ERWB24K14

Black cam  
2 side terminals  
35° make  
.256" "D" insert  
Replacement for GE

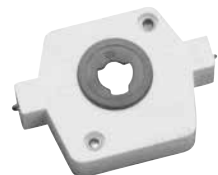

stem flat 6

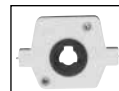

Also fits: Harper Wyman #1899G5003

# SPARK SWITCHES

## Order No. ERWB24K30

.256" "D" insert  
Replacement for GE

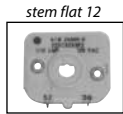

## Order No. ERWB24K10002

.256" "D" insert  
Replacement for GE

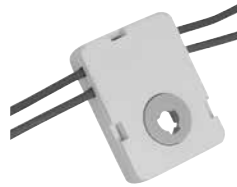
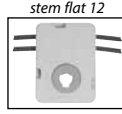

## Order No. ERWB24K10017

.256" "D" insert  
Replacement for GE

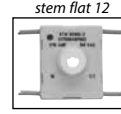

## Order No. ERWB24T10071

.256" "D" insert  
Replacement for GE



## Order No. ERWB24X412

Dark green cam  
2 side terminals  
96° make  
.340" "D" insert  
Replacement for GE



Also fits: Harper Wyman #1899G0009

## Order No. ERWB24X448

White cam  
1 side/1 back terminal  
160° make  
.340" "D" insert  
Replacement for GE

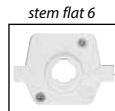

Also fits: Harper Wyman #1899G0005

## Order No. ER1254

Pink cam  
2 side terminals  
80° make  
.340" "D" insert  
Replacement for Peerless



Also fits: Harper Wyman #1899G0027

## Order No. ER60141

100° make  
.340" "D" insert  
Replacement for Peerless

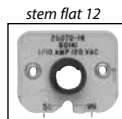

## Order No. ER60065

100° make  
.340" "D" insert  
Replacement for Peerless

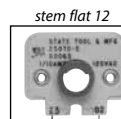

## Order No. ER27001

Micro Switch  
Replacement for Slattery  
Used with ER27009

NLA  
from  
OEM



## Order No. ER27009

74° make  
.340" "D" insert  
Replacement for Slattery

NLA  
from  
OEM



## Order No. ER1832371

Yellow cam  
2 side terminals  
78° make  
.340" "D" insert  
Replacement for Whirlpool

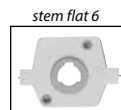

Also fits: Harper Wyman #1899G0014

# SPARK SWITCHES

## Order No. ER314096

Light blue cam  
2 side terminals  
25° make  
.340" "D" insert  
Replacement for  
Whirlpool

**NLA**  
from  
OEM

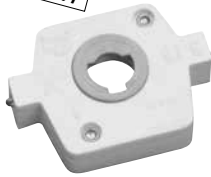

stem flat 6



Also fits: Harper Wyman #1899G0021

## Order No. ER3185830

.340" "D" insert  
Replacement for Whirlpool

**NEW!**



stem flat 12



## Order No. ER4157180

Orange cam  
1 side/1 back terminal  
56° make  
.340" "D" insert  
Replacement for  
Whirlpool



stem flat 12

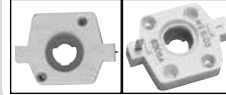

Also fits: Harper Wyman  
#1899G0013

## Order No. ER4168745

Black cam  
2 side terminals  
148° make  
.340" "D" insert  
Replacement for  
Whirlpool



stem flat 6

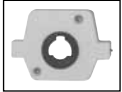

Also fits: Harper Wyman #1899G0025

## Order No. ER4173112

Red cam  
2 back terminals  
150° make  
.340" "D" insert  
Replacement for  
Whirlpool



stem flat 12

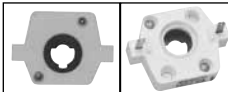

Also fits: Harper Wyman  
#1899G0035

## Order No. ER4330739

White cam  
2 side terminals  
160° make  
.340" "D" insert  
Replacement for  
Whirlpool



stem flat 6



Also fits: Harper Wyman #1899G0001

## Order No. ER74007095

.256" "D" insert  
Replacement for Whirlpool

**NEW!**



stem flat 6



## Order No. ER74007096

.256" "D" insert  
Replacement for Whirlpool



stem flat 6



## Order No. ER74007753

.256" "D" insert  
Replacement for Whirlpool

**NEW!**



stem flat 8



## Order No. ER74007774

.256" "D" insert  
Replacement for Whirlpool

**NEW!**



stem flat 3



## Order No. ER7403P10760

74° make  
.340" "D" insert  
Replacement for GE, Whirlpool



stem flat 7



## Order No. ER7403P19060

75° make  
.340" "D" insert  
Replacement for Whirlpool



stem flat 7



# SPARK SWITCHES

## Order No. ER7403P25960

75° make  
.340" "D" insert  
Replacement for Whirlpool

stem flat 2/7



## Order No. ER7403P28460

74° make  
.340" "D" insert  
Replacement for Whirlpool

stem flat 2



## Order No. ER786130

Dark red cam - 2 side terminals  
148° make - .340" "D" insert  
Replacement for Whirlpool

stem flat 12

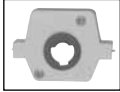

Also fits: Harper Wyman #1899G0026



## Order No. ER82486

Light brown cam - 1 side/1 back terminal  
46° make - .340" "D" insert  
Replacement for Whirlpool

stem flat 9



Also fits:  
Harper Wyman #1899G0031, Dacor #82486

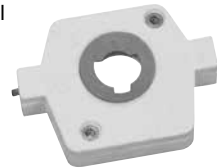

## Order No. ERY0042053

Dark red cam - 2 side terminals  
148° make - .340" "D" insert  
Replacement for Whirlpool

stem flat 12



Also fits: Harper Wyman #1899G0023

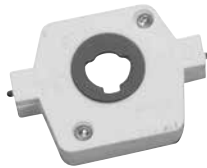

## Order No. ERY0310974

54° make  
.340" "D" insert  
Replacement for Whirlpool

stem flat 12



NLA  
from  
OEM



## Order No. ERY07721000

Oven Switch

.340" "D" insert  
Replacement for Whirlpool

stem flat 12

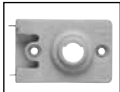

## Order No. ERY704512

Brown cam - 2 side terminals  
160° make - .340" "D" insert  
Replacement for Whirlpool

stem flat 9



Also fits: Harper Wyman #1899G0037



## Order No. ERY704513

Dual Switch

Light blue & white cam  
25° & 160° make - .340" "D" insert  
Replacement for Whirlpool

stem flat 6



Also fits: Harper Wyman #1899G0036



**LET ERP PROMOTE FOR YOU!**

**We can create custom  
flyers/mailers for all our  
authorized ERP distributors**

**Call for details  
800-377-1355**



# SPARK SWITCHES

## Spark Switch Cross Reference

OEM Part #	ERP #	PG	OEM Part #	ERP #	PG	OEM Part #	ERP #	PG	OEM Part #	ERP #	PG
<b>BROWN</b>			<b>GARLAND</b>			27009*			4331070		
1801A152	ER1801A152	56	1593101	ER314096	58	<b>STATE TOOL</b>			4331311	ERWB24X412	57
1801A153	ER1801A153	56	<b>GRAY/DUDLEY</b>			25045-10	ER7403P19060	58	4332653	ER1802A223	56
1801A165	ER1801A165	56	518860	ER4330739	58	25045-3	ER7403P10760	58	4364045	ER1802A223	56
1802A207	ER1802A207	56	<b>HARPER-WWYMAN</b>			25070-14	ER316032001	56	4371298	ER316032001	56
1802A223	ER1802A223	56	1899G0001	ER4330739	58	25070-16	ER60141	57	71003385	ER4330739	58
<b>CHAMBERS See Whirlpool</b>			1899G0005	ERWB24X448	57	25070-17	ER316032000	56	74007095	ER74007095	58
<b>CROWN/GAFFERS &amp; SATLER</b>			1899G0009	ERWB24X412	57	25070-2	ER27009	57	74007096	ER74007096	58
518360	ER4330739	58	1899G0013	ER4157180	58	25070-22	ER316035200	56	74007753	ER74007753	58
<b>DACOR</b>			1899G0014	ER1832371	57	25070-23	ER316035201	56	74007774	ER74007774	58
82486	ER82486	59	1899G0021	ER314096	58	25070-5	ER60065	57	74-03-116*	ER1254	57
<b>ELECTROLUX</b>			1899G0023	ERY0042053	59	25070-6	ERY0310974	59	7403P107-60	ER7403P10760	58
316032000	ER316032000	56	1899G0025	ER4168745	58	25095-1	ER7403P28460	59	7403P146-60	ER1802A223	56
316032001	ER316032001	56	1899G0026	ER786130	59	25100-4	ER7403P25960	59	7403P190-60	ER7403P19060	58
316035200	ER316035200	56	1899G0027	ER1254	57	25200-7	ERY07721000	59	7403P259-60	ER7403P25960	59
316035201	ER316035201	56	1899G0031	ER82486	59	25600-3	ER74007096	58	7403P284-60	ER7403P28460	59
5301321332*	ER4330739	58	1899G0035	ER4173112	58	25800-0	ERWB24K30	57	7403P285-60	ER7403P25960	59
5303285785	ER1801A152	56	1899G0036	ERY704513	59	H30900-206	ERWB24K10017	57	786130	ER4168745	58
5303285786*	ER1802A207	56	1899G0037	ERY704512	59	<b>THERMADOR</b>			878009	ER1802A207	56
5308008371*	ER1802A223	56	1899G5003	ERWB24X14	56	414568	ERWB24X448	57	OS-030-048-99*	ER4168745	58
<b>GE/HOTPOINT</b>			1899G0043	ERWB24K1	56	413996	ER1801A153	56	OS-030-052-99*	ER1801A165	56
WB13M1	ERWB13M1	56	5199G0002	ER1802A207	56	800126	ER314096	58	OS-030-054-99*	ER1802A207	56
WB21X5340	ER1802A207	56	5199G0003	ER1802A223	56	<b>TURCO</b>			Y0042053	ER786130	59
WB21X5341	ER1801A152	56	<b>JENN-AIR See Whirlpool</b>			2509340	ER314096	58	Y0061440*	ER4330739	58
WB24K1	ERWB24K1	56	<b>KITCHENAID See Whirlpool</b>			<b>WHIRLPOOL</b>			Y0301326	ER1801A153	56
WB24K10002	ERWB24K10002	57	<b>MAYTAG See Whirlpool</b>			0042054*	ER1801A152	56	Y0309003	ER4330739	58
WB24K10017	ERWB24K10017	57	<b>PEERLESS</b>			12500019	ER7403P25960	59	Y0310974*	ERY0310974	59
WB24K13*	ER4157180	58	1178	ER1802A207	56	1832371	ER1832371	57	Y07455200*	ER4157180	58
WB24K14	ERWB24K14	56	1191	ER1802A207	56	2009014*	ERWB24X448	57	Y07721000	ERY07721000	59
WB24K30	ERWB24K30	57	1191	ER1802A223	56	204512*	ERY704512	59	Y704269	ER4330739	58
WB24T10071	ERWB24T10071	57	1197	ER1802A223	56	307162*	ER4173112	58	Y704512	ERY704512	59
WB24X379	ER316035200	56	1254	ER1254	57	310253*	ER4330739	58	Y704513	ERY704513	59
WB24X402*	ER7403P10760	58	1256	ER786130	59	311389*	ERWB24X448	57	Y704928	ER4330739	58
WB24X411	ER1802A223	56	59714	ER1802A207	56	312457*	ERWB24X412	57			
WB24X412	ERWB24X412	57	60065	ER60065	57	314096*	ER314096	58			
WB24X419*	ER4330739	58	60141	ER60141	57	318432*	ER1802A223	56			
WB24X448	ERWB24X448	57	<b>ROPER See Whirlpool</b>			3185830	ER3185830	58			
WB24X5193*	ER1802A207	56	<b>SLATTERY</b>			4157180	ER4157180	58			
WB24X5194*	ER4157180	58	04011*	ER1802A207	56	4168745	ER4168745	58			
WB24X5260*	ER7403P19060	58	04012*	ER1802A223	56	4173112*	ER4173112	58			
WB24X5274	ER7403P25960	59	27001*	ER27001	57	4330739	ER4330739	58			

\* Spark Switch is NLA from OEM - still available at ERP

For up-to-date cross reference, go to [www.erparts.com](http://www.erparts.com)

# GAS OVEN THERMOSTATS

## Order No. ER1802A241

7/8" shaft  
2 outlets  
Standing pilot  
Spring clip mount

NLA  
from  
OEM



Replaces:  
Brown #1802A241

## Order No. ER1802A290

1-1/4" shaft  
3 outlets  
Standing pilot  
Bolt thru mount

Replaces:  
Brown #1802A290  
Harper Wyman #5362G0013



## Order No. ER1802A291

1-1/4" shaft  
2 outlets  
Spark ignition  
Bolt thru mount

Replaces:  
Brown #1802A202, #1802A291  
Harper Wyman #5396G0017



## Order No. ER1802A319

Has 7/8" shaft

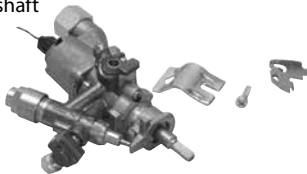

Replaces:  
Brown #1802A319

## Order No. ER316279400

1-3/16" shaft  
2 outlets  
Standing pilot  
Bolt thru mount

Replaces:  
Electrolux #316279400  
Harper Wyman #5392G0021

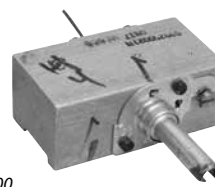

## Order No. ER5300007880

5/8" shaft  
2 outlets  
Standing pilot  
Bolt thru mount

Replaces:  
Electrolux #5300007880  
Harper Wyman #5393G0001

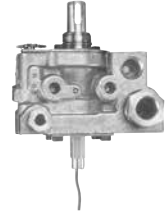

## Order No. ER5308013927

7/8" shaft  
2 outlets  
Standing pilot  
Spring clip mount

NLA  
from  
OEM



Replaces:  
Electrolux #3204974

## Order No. ERWB20K2

3/4" shaft  
2 outlets  
Standing pilot  
Bolt thru mount

Replaces:  
GE #WB20K2  
Harper Wyman #5392G0012



## Order No. ERWB20K10013

3/4" shaft  
3 outlets  
Standing pilot  
Bolt thru mount

Replaces:  
GE #WB20K10013



## Order No. ERWB21X5231

1-5/16" shaft  
2 outlets  
Spark ignition  
Flange mount

Replaces:  
GE #WB21X5231  
Harper Wyman #5394G0022



## Order No. ERWB21X10103

3/4" shaft  
2 outlets  
Standing pilot  
Bolt thru mount

Replaces:  
GE #WB21X10103  
Harper Wyman #5392G0012



**NEW!**

## Order No. ER1192

7/8" shaft  
2 outlets  
Standing pilot  
Flange mount

Replaces:  
Peerless #1192  
Harper Wyman #5390G0019, #5390G0022



## Order No. ER1193

1-1/16" shaft - 2 outlets  
Spark ignition  
Flange mount  
Replacement for Peerless

Replaces:  
Peerless #1193  
Harper Wyman #5394G0022

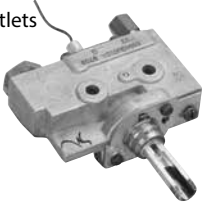

## Order No. ER1194

1-1/8" shaft  
3 outlets  
Standing pilot  
Bolt thru mount

Replaces:  
Peerless #1194  
Harper Wyman #5362G0016



## Order No. ER1195

1-1/8" shaft  
2 outlets  
Spark ignition  
Bolt thru mount

Replaces:  
Peerless #1195  
Harper Wyman #5396G0020



COOKING

# GAS OVEN THERMOSTATS

## Order No. ER04008

1-1/2" shaft  
2 outlets  
Standing pilot  
Flange mount

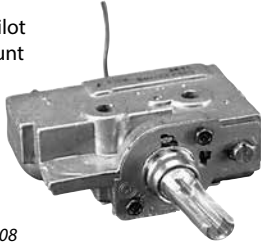

Replaces:  
Slattery #04008  
Harper Wyman #5390G0003, #5390G0005

## Order No. ER74006182

7/8" shaft  
3 outlets  
Standing pilot  
Bolt thru mount



Replaces:  
Whirlpool #74006182, #74002425  
Harper Wyman #5362G0019, #5362G0015

## Order No. ER98015087

15/16" shaft  
2 outlets  
Standing pilot  
Bolt thru mount



Replaces:  
Whirlpool #98015087  
Harper Wyman #5392G0023

## Order No. ERR0711030

1" shaft  
3 outlets  
Standing pilot  
Includes pilot  
adjustment  
fitting



Replaces:  
Whirlpool #R0711030  
Harper Wyman #5362G0002

## Order No. ERR0711031

15/16" shaft  
2 outlets  
Spark ignition  
Bolt thru mount



Replaces:  
Whirlpool #R0711031  
Harper Wyman #5396G0010

## Order No. ERR0711508

1" shaft  
2 outlets  
Standing pilot  
Flange mount

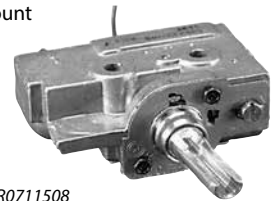

Replaces:  
Whirlpool #R0711508  
Harper Wyman #5390G0003

## Order No. ER5362S0006

2" break-off shaft, 3 outlets,  
Standing pilot  
Bolt thru mount  
Horizontal body type  
Includes pilot plug

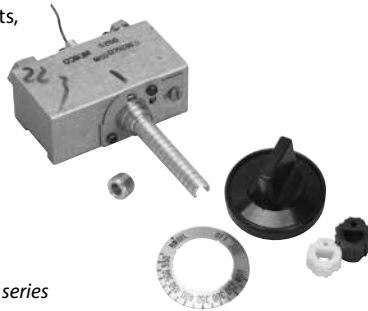

Replaces:  
Most Harper Wyman 5362 series

## Order No. ER5390S0018

2" break-off shaft  
2 outlets  
Standing pilot  
Flange mount  
Horizontal body type

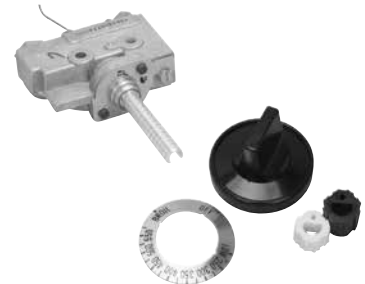

Replaces:  
Most Harper Wyman 5390 series

## Order No. ER5394S0021

2" break-off shaft  
2 outlets  
Spark ignition  
Flange mount  
Horizontal body type

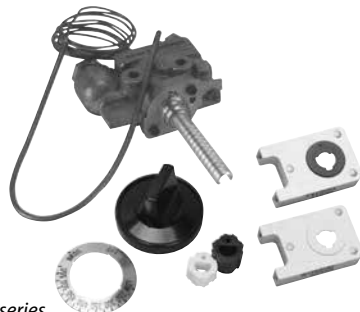

Replaces:  
Most Harper Wyman 5394 series

## Order No. ER5396S0012

2" break-off shaft, 2 outlets  
Spark ignition  
Bolt thru mount  
Horizontal body type

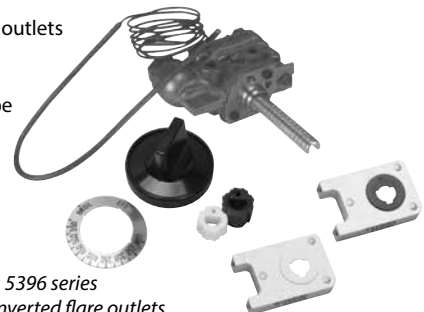

Replaces:  
Most Harper Wyman 5396 series  
thermostats except inverted flare outlets

# GAS OVEN THERMOSTATS

## Gas Oven Thermostat Cross Reference

OEM Part #	ERP #	ERP Kit #
<b>ATHENS</b> <i>See Electrolux</i>		
<b>BROWN</b>		
1802A201*	ER5392G0001	ER5362S0006
1802A202*	ER5396G0017	✗
1802A215*	✗	ER5390S0018
1802A222*	✗	ER5394S0021
1802A241*	ER1802A241	✗
1802A244*	ER5362G0013	✗
1802A290	ER5362G0013	✗
1802A291	ER5396G0017	✗
<b>CROWN</b>		
518740	✗	ER5394S0021
<b>ELECTROLUX</b>		
316052900*	ER5392G0021	ER5362S0006
316279400*	ER5392G0021	ER5362S0006
316935004*	ER5392G0021	ER5362S0006
3204974*	ER5308013927	✗
5300367094*	ER5397G0005	✗
5303131886*	ER5303131886	✗
5303201272*	ER5303201272	✗
5303208045*	ER5303208045	✗
5303285726*	ER5362G0013	ER5362S0006
5303326546*	ER5396G0017	✗
5303935014*	ER5392G0021	ER5362S0006
5303935016*	ER5392G0021	ER5362S0006
5308013927*	ER5308013927	✗
P367064*	ER5393G0001	✗
<b>GE/HOTPOINT</b>		
WB20K10013*	ERB20K10013	✗
WB20K2	ER5392G0012	ER5362S0006
WB20K5010*	✗	ER5396S0099
WB21X374*	ER5390G0003	ER5390G0022
WB21X426*	ERWB21X426	✗
WB21X460*	ER5396G0009	ER5396S0012
WB21X466	✗	ER5396S0099
WB21X471	ER5392G0019	ER5392S0099
WB21X472*	ER5392G3002	ER5392S0099

OEM Part #	ERP #	ERP Kit #
WB21X5231*	ER5394G0022	ER5394S0021
WB21X5314*	✗	ER5362S0006
WB21X5342	ER5362G0013	ER5362S0006
WB21X5343	ER5396G0017	ER5396S0012
WB21X10103	ERWB21X10103	✗
<b>MAGIC CHEF</b> <i>See Whirlpool</i>		
<b>MAYTAG</b> <i>See Whirlpool</i>		
<b>PEERLESS</b>		
1177	ER5394G0005	ER5394G0022
1179*	ER1182	✗
1182	ER1182	✗
1187	ER5391G0007	✗
1192	ER5390G0019	ER5390G0022
1193	ER5394G0022	✗
1194	ER5362G0016	ER5362S0006
1195	ER5396G0020	✗
<b>ROPER</b> <i>See Whirlpool</i>		
<b>SLATTERY</b>		
04008*	ER5390G0005	ER5390G0003
04010*	ER5394G0007	ER5394S0021
<b>WHIRLPOOL</b>		
0086986	ER0086986	✗
0089060*	ER5390G0003	ER5390S0018
0089061*	ER5394G0003	ER5394G0022
07454300*	ER5390G0003	ER5390S0018
07454400*	ER5394G0003	ER5394G0022
07595600*	ERR0711505	✗
306533*	ER306533	✗
321983*	✗	ER5396S0099
323467*	ER5392G3001	ER5392S0099
325660*	✗	ER5396S0099
325661*	ER5392G3001	ER5392S0099
330596*	✗	ER5396S0099
334901*	ER5392G0019	ER5392S0099
336744*	✗	ER5396S0099
1888432*	✗	ER5396S0012
1888434*	✗	ER5362S0006

OEM Part #	ERP #	ERP Kit #
1888443*	✗	ER5362S0006
4314890	ER5396G0010	ER5396S0012
4332667*	ER5396G0001	ER5396S0012
4333531*	ER5396G3002	ER5396S0099
4333882*	ER5392G3001	ER5392S0099
4336370*	✗	ER5396S0099
4337363*	ER5392G3001	ER5392S0099
4337866*	✗	ER5396S0099
4364125	ER5362G0016	ER5362S0006
4371693*	ER5392G0021	ER5362S0006
4372114*	ER5392G0021	ER5362S0006
74002425*	ER5362G0015	ER5362S0006
74006182	ER5362G0019	ER5362S0006
7515P001-60*	✗	ER5362S0006
7515P004-60*	ER5392G0012	ER5362S0006
7515P013-60*	✗	ER5396S0012
7515P022-60*	ER5396G0009	ER5396S0012
7515P023-60*	✗	ER5362S0006
7515P028-60*	ER7515P02860	✗
7515P033-60*	✗	ER5362S0006
7515P036-60	✗	ER5362S0006
7515P038-60*	ER5362G0015	ER5362S0006
7515P041-60*	ER5362G0015	ER5362S0006
98015087	ER5392G0023	ER5362S0006
OC-010-140-99*	EROC01014099	✗
OC-010-141-99*	ER5390G0001	ER5390S0018
OC-010-146-99*	ER5390G0007	ER5390S0018
OC-010-147-99*	✗	ER5394S0021
OC-010-152-99*	✗	ER5396S0012
R0157535*	ER5394G0003	ER5394S0021
R0711025*	ERR0711505	✗
R0711030	ER5362G0002	✗
R0711031	ER5396G0010	✗
R0711508*	ER5390G0003	ER5390S0018
Y07595601	ER5396G0010	✗
Y07720600*	ERR0711505	✗

\* Gas oven thermostat is NLA from OEM - still available at ERP

For up-to-date cross reference, go to [www.erparts.com](http://www.erparts.com)

# SAFETY VALVES

Order No. ER5817S0007

## Universal Kit

14" capillary  
 3/8" cc inlet  
 Includes:  
 (1) 3/8" cc ferrule  
 (1) 3/8" cc nut w/ breakoff ferrule  
 (1) 1/4" cc nut w/ breakoff ferrule  
 (1) 1/4"M x 3/8"cc F nut (installed)  
 Mounting brackets = (1) side (3) bottom  
**Replaces 90% of all 5817 series safety valves**

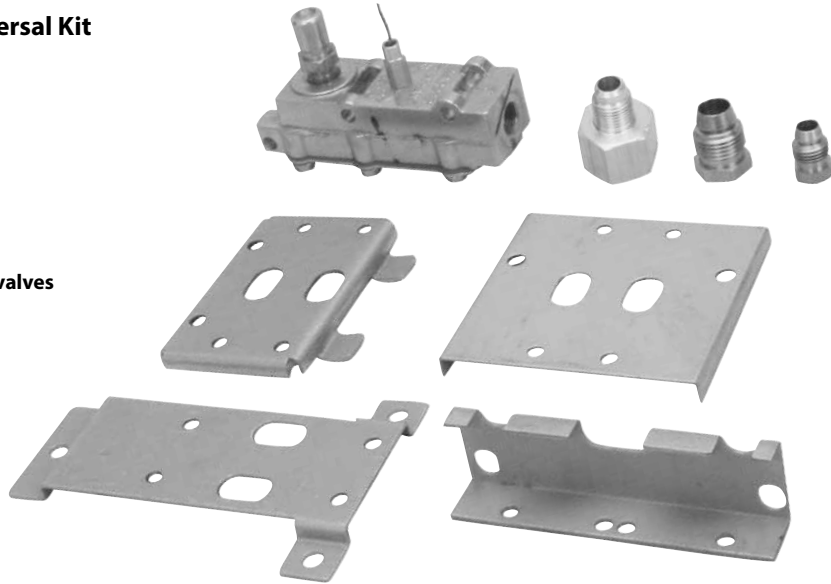

Replaces:  
 Harper Wyman # 5817S0007

Order No. ER1802A155

7/16" inlet



Replaces:  
 Brown #1802A155, #1802A154  
 Harper Wyman # 5813H0129

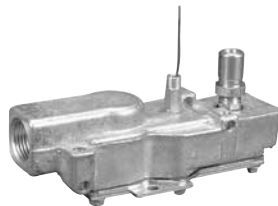

Order No. ER1802A206

3/8" inlet  
 Includes mounting bracket

Replaces:  
 Brown #1802A205, #1802A206  
 Electrolux #5303285749  
 GE #WB21X5344, #WB21X5345  
 Harper Wyman #5817G0004,  
 #5817S0012

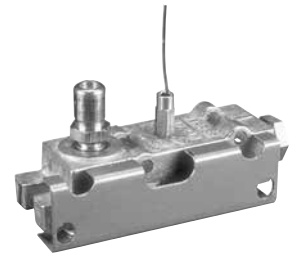

Order No. ER1802A298

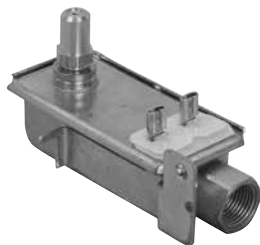

Replaces:  
 Brown #1802A298

Order No. ER3203459



Replaces:  
 Electrolux #3203459  
 Invensys # Y30128-35AF  
 Whirlpool #814412

Order No. ER318087200

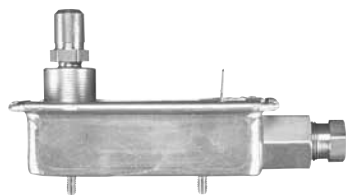

Replaces:  
 Electrolux #318087200

Order No. ER5308008362

3/8" inlet  
 Includes mounting bracket

Replaces:  
 Electrolux #5308008362  
 Harper Wyman # 5817G0001

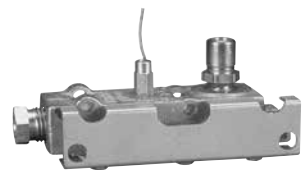



# SAFETY VALVES

## Order No. ER5308009419

3/8" inlet  
1/4" female terminals

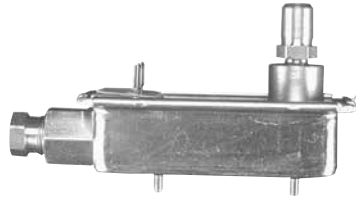

Replaces:  
Electrolux #5308009419

## Order No. ERWB19K12

3/8" inlet  
Includes mounting bracket  
Has special threaded fitting below the orifice outlet



Replaces:  
GE #WB19K12  
Harper Wyman # 5817H0088

## Order No. ERWB19K31

1/4" female terminals

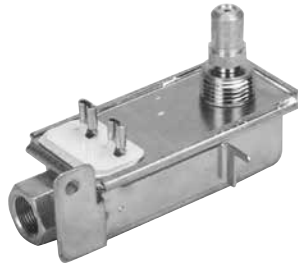

Replaces:  
GE #WB19K31

## Order No. ER1285

3/8" inlet  
Has bottom bracket



Replaces:  
Harper Wyman # 5817G0100, #5817G0119  
Peerless #1282, #1285  
Whirlpool #4364168

## Order No. ER4157094

3/8" inlet  
Includes mounting bracket

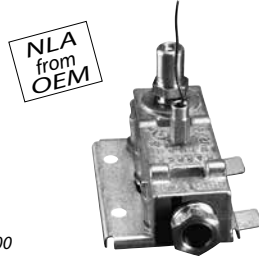

Replaces:  
GE #WB21X5232  
Harper Wyman # 5817H0003  
Whirlpool #4157094, #4371106, #Y07454500

## Order No. ER12002724

3/8" inlet  
Includes mounting bracket

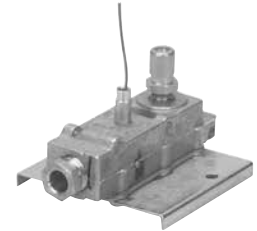

Replaces:  
Harper Wyman # 5817G0121, #5817G0137  
Whirlpool #12002724, #74002428,  
#7501P162-60, #7501P185-60

## Order No. ER4333718

3/8" inverted flare inlet  
Includes mounting bracket

NLA from OEM

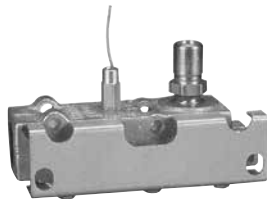

Replaces:  
GE #WB21X474  
Harper Wyman # 5817H0057  
Whirlpool #322814, #321795, #4333718

## Order No. ER5800S0001

7/16" inlet  
14" capillary  
Includes fittings shown

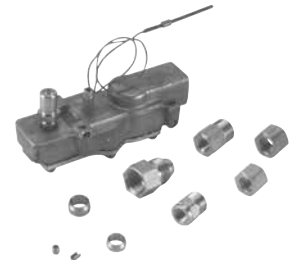

Replaces:  
Brown #1802A154, 1802A155  
Harper Wyman # 5800S0001  
Slattery #04015  
Welbilt #BPF1-9

## Order No. ER5817S0009

Includes special threaded fitting below orifice hood  
14" capillary

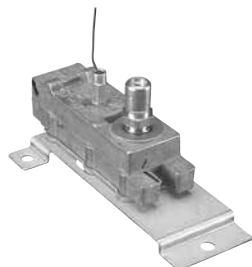

Replaces:  
Electrolux #5303280593, #5303285054  
Harper Wyman # 5817H0090

## Order No. ER5817S0010

3/8" inverted flare inlet kit  
14" capillary  
Includes: (1) 1/4" M x 3/8" cc F inverted flare nut (installed), (1) mounting bracket  
Replaces most 3/8" inverted flare safety valves



Replaces: GE #WB21X474, Harper Wyman # 5817H0057, Whirlpool #4333718

COOKING

# SAFETY VALVES

## Order No. ER5817S0011

14" capillary



Replaces:  
Harper Wyman # 5817G0133D  
Whirlpool #98007444

## Order No. ER7501P13660

3/8" inlet  
1/4" female terminals

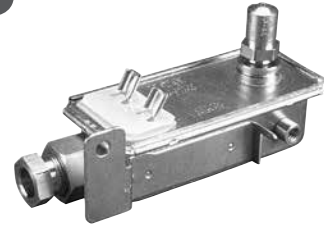

Replaces:  
Whirlpool #7501P13660

## Safety Valve Cross Reference

OEM Part #	ERP #	ERP KIT #
<b>ATWOOD</b>		
56120	ER56120	×
<b>BROWN</b>		
1802A154 - LP*	ER1802A155	ER5800S0001
1802A155*	ER1802A155	ER5800S0001
1802A205 - LP	ER1802A206	×
1802A206	ER1802A206	×
1802A239	ER1802A239	×
1802A298	ER1802A298	×
<b>ELECTROLUX</b>		
318087200	ER318087200	×
3203459	ER3203459	×
5303208027*	ER5303208027	×
5303280593	×	ER5817S0009
5303285054 - LP	ER5303285054 - LP	ER5817S0009
5303285749	ER1802A206	×
5308008362	ER5308008362	ER5817S0007
5308009419	ER5308009419	×
5308013942	ER5308013942	×
<b>GE/HOTPOINT</b>		
164D2575G001	ERWB19K12	ER5817S0008
183D5746G001	ERWB19K31	×
WB19K12	ERWB19K12	×
WB21X351*	ERWB21X351	ER5817S0007
WB21X431	ERWB21X431	×
WB21X474	×	ER5817S0010
WB21X5232*	ERWB21X5253	ER5817S0007
WB21X5274*	ER7501P13660	×
WB21X5344 - LP*	ER1802A206	×
WB21X5345	ER1802A206	×
<b>HARPER WYMAN</b>		
5817G0001	ER5308008362	ER5817S0007

OEM Part #	ERP #	ERP KIT #
5817G0004	ER1802A206	ER5817S0007
5817G0007	ER1802A206	ER5817S0007
5817G0100	ER1282	ER5817S0007
5817G0119	ER1285	ER5817S0007
5817G0121	ER12002724	ER5817S0007
5817G0133-C	ER98005639	×
5817G0133-D	ER98007444	×
5817G0137	ER12002724	ER5817S0007
5817G1108	ER74001018	×
5817H0003	ER4157094	ER5817S0007
5817H0008	ER1279	ER5817S0007
5817H0023	ER04013	ER5817S0007
5817H0057	ER4333718	ER5817S0010
5817H0063	ER4333718	ER5817S0010
5817H0088	ERWB19K12	ER5817S0008
5817H0090	ER5303280593	ER5817S0009
5817H0098	ER7501P00060	ER5817S0007
5817H0105	ER74010590	ER5817S0007
5817H0140	ER74010590	ER5817S0007
<b>MAYTAG See Whirlpool</b>		
<b>PEERLESS PREMIER</b>		
1279	ER1279	×
1280	ER1280	×
1282	ER1282	ER5817S0007
1285	ER1285	ER5817S0007
<b>ROPER See Whirlpool</b>		
<b>SLATTERY</b>		
040-13*	ER04013	×
040-30	ER04030	×
<b>WHIRLPOOL</b>		
12002724	ER12002724	5817S0007
318482*	ER4333718	5817S0010

OEM Part #	ERP #	ERP KIT #
321755*	ER4333718	5817S0010
321795*	ER4333718	5817S0010
322814*	ER4333718	5817S0010
323680*	ER4333718	5817S0010
324078*	ER4333718	5817S0010
4157094	ER4157094	5817S0007
4333718	ER4333718	5817S0010
4364168	ER4364168	5817S0007
4371106*	ER4157094	5817S0007
74001018	ER74001018	×
74002428	ER12002724	5817S0007
74003311*	ER7501P13660	×
74010590	ER74010590	5817S0007
7501P015-60*	ER7501P13660	×
7501P111-60	ER7501P11160	ER5817S0007
7501P121-60*	ER74001018	×
7501P136-60	ER7501P13660	×
7501P162-60*	ER12002724	5817S0007
7501P185-60*	ER12002724	5817S0007
7501P227-60*	ER74010590	×
814412	ER814412	×
98005639	ER98005639	×
98007444	ER98007444	×
Y07454500*	ER4157094	5817S0007

\* Safety Valve is NLA from OEM - still available at ERP

For up-to-date cross reference, go to [www.erparts.com](http://www.erparts.com)

# OVEN PILOTS

## Order No. ER5414S0109

Standing pilot  
Left hand mounting

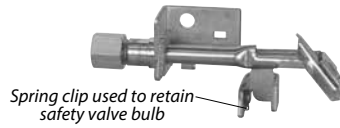

Replaces:  
Harper Wyman # 5414S0109  
Used with Harper Wyman 5817 series safety valves

## Order No. ER5414S0308

Spark igniter bracket attached  
Left hand mount

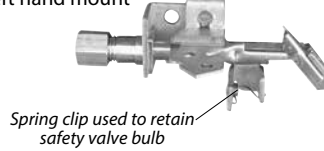

Replaces:  
Harper Wyman # 5414S0308  
Used with Harper Wyman 5817 series safety valves

## Order No. ER5415H0101

Standing pilot  
Right hand mounting

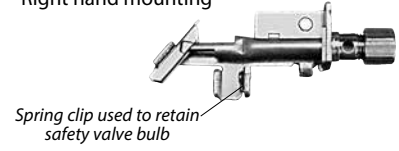

Replaces:  
Harper Wyman # 5415H0101  
Used with Harper Wyman 5817 series safety valves

## Order No. ER1566267

Left hand mounting



Replaces:  
Whirlpool # 1566267  
Robertshaw # 1898-021

## Order No. ER1802A326

Spark Ignition

**NEW!**



Replaces:  
Brown #1802A326

## Order No. ERWB19K10008

Standing pilot  
Used on millivolt system  
with #WB20K10013  
oven thermostat.



Replaces:  
GE # WB19K10008

## Order No. ER74010141

Standing pilot

**NEW!**



Replaces:  
Whirlpool #74010141

## Oven Pilot Cross Reference

OEM Part #	ERP #
<b>BROWN</b>	
1802E67*	ER5414S0109
1802E68	ER5414S0308
1802A326	ER1802A326
<b>ELECTROLUX</b>	
5303285763	ER5414S0109
5303285783	ER5414S0308

\* Oven pilot is NLA from OEM - still available at ERP

OEM Part #	ERP #
5308011474*	ER5414S0109
<b>GE/HOTPOINT</b>	
WB2X8543*	ER5414S0109
WB2X8544	ER5414S0308
WB19K10008	ER19K10008
WB19K10025	ERWB19K10025
WB19K10028	ERWB19K10028
WB2X9015	ER5414S0308
WB19K6	ER5414S0109
WB21X375*	ER5414S0109
WB21X5233	ER5414S0308
WB21X5300*	ER5415H0101
<b>PEERLESS PREMIER</b>	
1283	ER5414S0109
1284	ER5414S0308
<b>SLATTERY</b>	
04019*	ER5414S0109
04020*	ER5414S0308

OEM Part #	ERP #
<b>WHIRLPOOL</b>	
0089063*	ER5414S0109
0089064*	ER5414S0308
1566267	ER1566267
318486*	ER5414S0308
4332674	ER5414S0308
4363363	ER5414S0109
4364127	ER5414S0109
4364169	ER5414S0308
4371098*	ER5414S0308
74006183	ER5414S0109
74006408	ER5415H0101
74010141	ER74010141
7432P05660*	ER5415H0101
7505P01460	ER5414S0308
98004302	ER5414S0109
Y07697200	ER5414S0109
Y07697300	ER5414S0308

For up-to-date cross reference, go to [www.erparts.com](http://www.erparts.com)

# E/G OVEN THERMOSTATS

*Used on gas ranges with glow bar igniter*

## Order No. ER1802A302

7/8" shaft, 2 terminals  
120V, 5 amp, single pole  
36" capillary

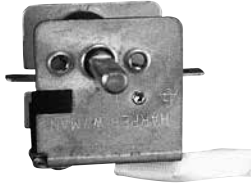

Replaces Brown #1802A302  
Harper Wyman #6460G0018

## Order No. ER1802A305

125V, 5 amp  
2 terminals



Replaces Brown #1802A305

## Order No. ER316032411

125V, 5 amp  
2 terminals



Replaces Electrolux #316032404,  
#316032411, #5303271464

## Order No. ER318059206

125V, 5 amp  
2 terminals

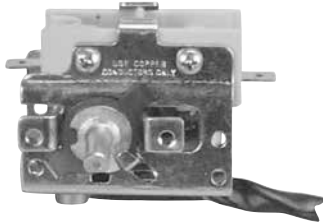

Replaces Electrolux #318059206

## Order No. ER5308013926

120V, 5 amp  
2 terminals

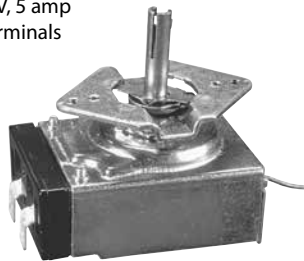

Replaces Electrolux #5308013926

## Order No. ERWB20K5

3/4" shaft, 2 terminals  
120V, 5 amp, single pole  
36" capillary

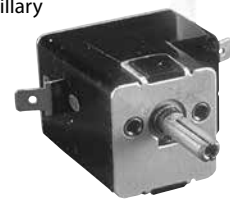

Replaces GE #WB20K5  
Harper Wyman #6440G0008

## Order No. ERWB20K6

3/4" shaft, 2 terminals  
120V, 5 amp, single pole  
36" capillary



Replaces GE #WB20K6  
Harper Wyman #6440G0014

## Order No. ERWB20K8

3/4" shaft, 2 terminals  
120V, 5 amp, single pole  
36" capillary

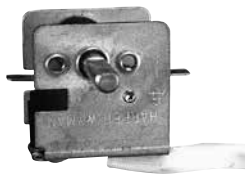

Replaces GE #WB20K8  
Harper Wyman #6460G0003

## Order No. ERWB20K10023

120V, 20 amp  
2 terminals

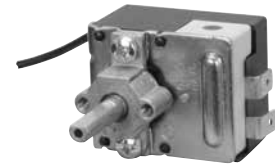

Replaces GE #WB20K10008,  
#WB20K10023

## Order No. ERWB21X5273

125V, 5 amp  
2 terminals



Replaces GE #WB21X5273

## Order No. ER12400034

125V, 5 amp  
2 terminals

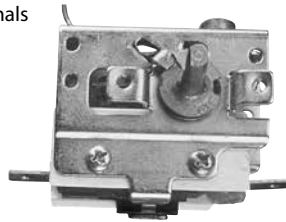

Replaces Whirlpool #12400034,  
#7404P062-60, #7515P019-60

## Order No. ER74002390

125V, 5 amp  
2 terminals

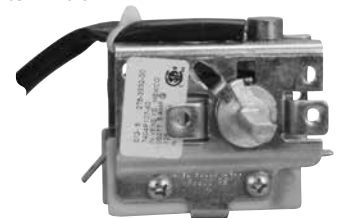

Replaces Whirlpool #74002390

# E/G OVEN THERMOSTATS

**Used on gas ranges with glow bar igniter**

**Order No. ER98003984**

3/4" shaft  
2 terminals  
120V, 5 amp  
Single pole  
36" capillary



Replaces Harper Wyman #6440G0018  
Whirlpool #98003984

**Order No. ERW10252619**

125V, 5 amp  
2 terminals



Replaces Whirlpool #4371308, #W10252619

**Order No. ERY07659500**

120V, 5 amp  
2 terminals



Replaces Whirlpool #Y07659500

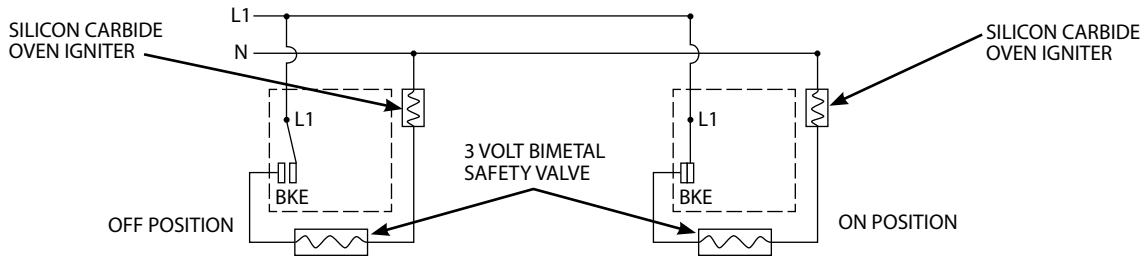

**Electric/Gas Oven Thermostat Cross Reference**

OEM Part #	ERP #
<b>AMANA</b> See Whirlpool	
<b>BROWN</b>	
1802A294	ER1802A302
1802A302	ER1802A302
1802A305	ER1802A305
<b>ELECTROLUX</b>	
316032404*	ER316032411
316032411	ER316032411
318059206	ER318059206
5303271464*	ER316032411
5308013926	ER5308013926
<b>GE/HOTPOINT</b>	
164D2536P001	ER98003984
164D2793P001	ERWB20K6
183D5463P001	ERWB20K8
223C3823P001	ERWB20K10023
223C3823P002	ERWB20K10023
WB20K10008	ERWB20K10023
WB20K10023	ERWB20K10023

OEM Part #	ERP #
WB20K5	ERWB20K5
WB20K6	ERWB20K6
WB20K8	ERWB20K8
WB21X5273	ERWB21X5273
<b>HARPER WYMAN</b>	
6440G0008	ERWB20K5
6440G0014	ERWB20K6
6440G0018	ER98003984
6460G0003	ERWB20K8
6460G0014	ER1802A302
6460G0018	ER1802A302
<b>INVENSYS</b>	
275-2998-00	ERY07659500
275-2998-01	ERY07659500
275-3100-01	ER316032411
275-3100-04	ER316032411
275-3106-00	ERWB21X5273
275-3140-05	ER12400034
275-3321-12	ER318059206

OEM Part #	ERP #
275-3332-00	ER74002390
275-3425-00	ER316032411
275-3426-00	ER318059206
275-3471-00	ER1802A305
275-3550-00	ER316032411
5441-069	ER5308013926
<b>WHIRLPOOL</b>	
12400034	ER12400034
4320594	ERY07659500
4371308	ERW10252619
74002390	ER74002390
7404P062-60	ER12400034
7404P087-60	ER316032411
7515P019-60	ER12400034
98003984	ER98003984
Y07659500	ERY07659500

\* E/G oven thermostat is NLA from OEM - still available at ERP

For up-to-date cross reference, go to [www.erparts.com](http://www.erparts.com)



# OVEN IGNITERS

Made in the USA



## Order No. ERIG0001

Flat style  
12" lead wires  
1-1/2" ceramic block  
Includes male/female two pin quick disconnect  
Stainless enclosure not included



Replaces Whirlpool #31940001

## Order No. ERIG21

Flat style  
8" lead wire  
1-1/2" ceramic block  
Includes male/female two pin quick disconnect

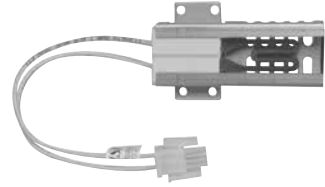

Replaces GE #WB13K21

## Order No. ERIG10016

Flat style  
Has (1) 15" lead wire to disconnect block with additional 12" lead and (1) 8" lead wire  
1-1/2" ceramic block  
Includes male/female two pin quick disconnect and jumper wires with 3/16" & 1/4" female crimped terminals

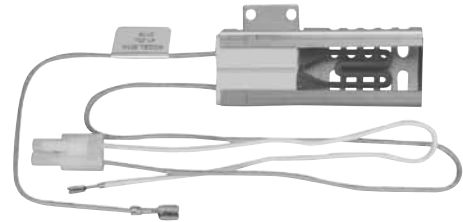

Replaces  
Electrolux #5303131300, GE #WB2X10016, Invensys #41-209

## Order No. ERIG5067

Flat style  
15" lead wires  
3-1/4" ceramic block

Replaces  
Electrolux #316T023P05,  
#5303935067  
GE #WB2X4306  
Invensys #41-202  
Norton #IGN2

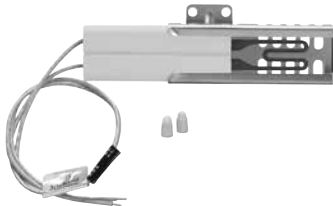

## Order No. ERIG5068

Flat style  
13" lead wires  
5-1/4" ceramic block

Replaces  
Electrolux #5303935068, Invensys #41-207, Norton #IGN7, Whirlpool #9751123

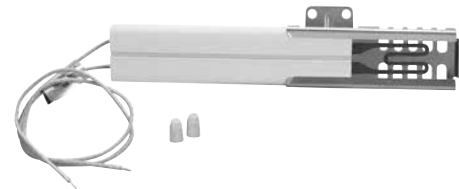

## Order No. ERIG35

Flat style  
8" lead wires  
1-1/2" ceramic block  
Includes male/female two pin quick disconnect, bracket, wires, ceramic wire nuts and insulation

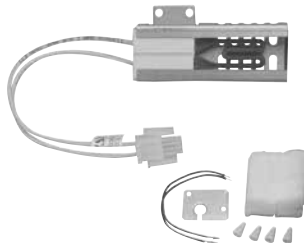

Replaces  
Electrolux #5312400035, GE #WB2X7934, Whirlpool #12400035

## Order No. ERIG5652

Flat style  
10" lead wires  
1-1/2" ceramic block  
Includes male two pin quick disconnect

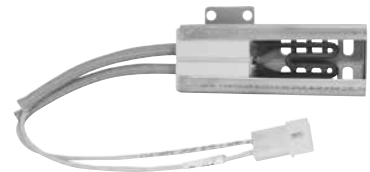

Replaces Whirlpool #98005652

## Order No. ERIG9159

Flat style - 12" lead wires  
5-1/4" ceramic block  
Includes stripped wires and ceramic wire nuts  
Stainless enclosure not included



Replaces Invensys #41-206, Norton #IGN6, Whirlpool #Y0309159

## Order No. ERIG9998

Flat style  
17" lead wires  
1-1/2" ceramic block  
Includes stripped wires and ceramic wire nuts

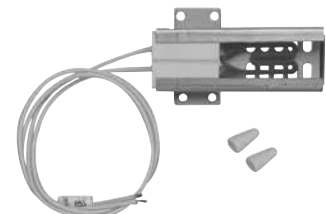

Replaces  
Brown #1802A300, #1802A303, Electrolux #5303935066  
GE #WB2X9998, Invensys #IGN5, Norton #41-205, Whirlpool #814269

# OVEN IGNITERS

## Order No. ERIG9400

Flat style  
16" lead wires  
1-1/2" ceramic block

**NEW!**

Replaces  
Electrolux #316489400



## Order No. ERGR403

Helical style  
3-1/2" overall length  
12" lead wires

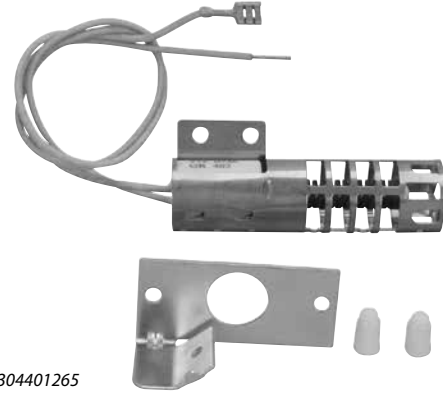

Replaces  
Electrolux #5304401265  
GE #WB2X9154  
Supco #SGR403  
Whirlpool #4342528

## Order No. ERGR205

Flat style  
17-3/4" lead wires  
1-1/2" ceramic block

Replaces  
Brown #1802A344, #1802A345  
Electrolux #5304462632  
Whirlpool #W10140611

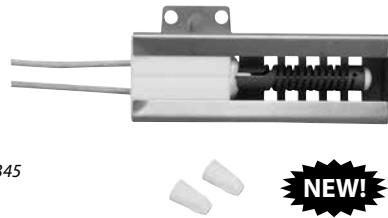

**NEW!**

## Oven Igniter Cross Reference

OEM PN	ERP PN
<b>AMANA</b> <i>See Whirlpool</i>	
<b>BROWN</b>	
1802A190*	ERGR403
1802A300	ERIG9998
1802A303	ERIG9998
1802A344	ERGR205
1802A345	ERGR205
<b>ELECTROLUX</b>	
316489400	ERIG9400
316489402	ERIG10016
5303935066	ERIG9998
5303935067	ERIG5067
5303935068	ERIG5068
5304401265	ERGR403
5304462632	ERGR205
5312400035	ERIG35
<b>GE</b>	
WB13K21	ERIG21
WB13T10001	ERIG9998

OEM PN	ERP PN
WB2X10016	ERIG10016
WB2X4306	ERIG5067
WB2X7934	ERIG35
WB2X9154	ERGR403
WB2X9998	ERIG9998
<b>INVENSYS</b>	
41-201	ERIG5068
41-202	ERIG5067
41-205	ERIG9998
41-206	ERIG9159
41-207	ERIG5068
41-209	ERIG10016
<b>MAYTAG</b> <i>See Whirlpool</i>	
<b>NORTON</b>	
501	ERIG9159
501A	ERIG5068
IGN2	ERIG5067
IGN5	ERIG9998
IGN6	ERIG9159

OEM PN	ERP PN
IGN7	ERIG5068
<b>ROBERTSHAW</b> <i>See Invensys</i>	
<b>SUPCO</b>	
SGR403	ERGR403
SGR408	ERIG9159
SGR412	ERIG9998
<b>WHIRLPOOL</b>	
12400035	ERIG35
31940001	ERIG0001
4342528	ERGR403
74007498	ERIG35
786324	ERIG9159
814269	ERIG9998
9751123	ERIG5068
98005652	ERIG5652
W10140611	ERGR205
Y0309159	ERIG9159

\* Oven igniter is NLA from OEM - still available at ERP

For up-to-date cross reference, go to [www.erparts.com](http://www.erparts.com)

# OVEN SPARK IGNITERS

## Order No. ER545072E01-51

51" lead wire, 2-3/16" porcelain,  
(1) .110" female spade terminal attached

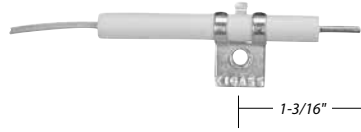

## Order No. ER545073E01-48

48" lead wire, 4-1/4" porcelain,  
(1) .110" female spade terminal



## Order No. ER545088E01-24

24" lead wire, 5" porcelain,  
(1) .110" female spade terminal



## Order No. ER5450S0073-RH

72" lead wire, 4-1/4" porcelain,  
(1) .110" female spade terminal loose  
(1) .250" female spade terminal loose  
Right hand mount



Replaces most 545073E02 series

## Order No. ER5450S0073-LH

72" lead wire, 4-1/4" porcelain,  
(1) .110" female spade terminal loose  
(1) .250" female spade terminal loose



Replaces most 545073E01 series

## Order No. ER545120E01-37

37" lead wire, (1) .110"  
female spade terminal  
attached

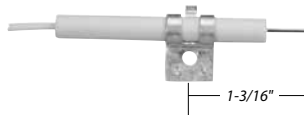

## Order No. ER27045

23" lead wire  
2-1/4" porcelain  
(1) .110" female spade  
terminal  
Has 90° bend at  
85° offset angle

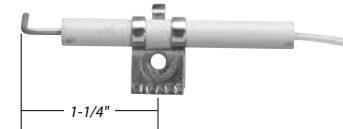

## Spark Igniter Cross Reference

OEM Part #	ERP #
<b>BROWN</b>	
1801B169	ER545120E01-37
1801B175	ER545072E01-51
<b>ELECTROLUX</b>	
5303285781*	ER545120E01-37
5308008368*	ER545072E01-51
5308011455*	ER545073E01-48
<b>GE/HOTPOINT</b>	
WB2X7331*	ER545072E01-51
WB2X9018	ER545072E01-51
WB2X10153*	ER545073E01-48
WB21X349*	ER545073E01-48
WB21X5351	ER545120E01-37

OEM Part #	ERP #
<b>HARPER WYMAN</b>	
545088E02-22	ER545073E01-48
<b>INVENSYS</b>	
41552	ER27045
<b>MAYTAG See Whirlpool</b>	
<b>PEERLESS</b>	
1482	ER545073E01-48
1489	ER27045
1490	ER545088E01-24
<b>ROPER See Whirlpool</b>	
<b>SLATTERY</b>	
27005*	ER545072E01-51
27038*	ER27045

OEM Part #	ERP #
27043*	ER545072E01-51
27045*	ER27045
<b>WHIRLPOOL</b>	
4335201	ER545072E01-51
4364044	ER545088E01-24
4389822*	ER545072E01-51
7432P035-60*	ER545088E02-22
8189500	ER545072E01-51
Y07491300	ER545072E01-51

\* Spark Igniter is NLA from OEM - still available at ERP

For up-to-date cross reference, go to [www.erparts.com](http://www.erparts.com)

# OVEN PROBES

Order No. ER12001655

Oven Probe Kit  
Kit includes two optional blocks  
Fits most applications

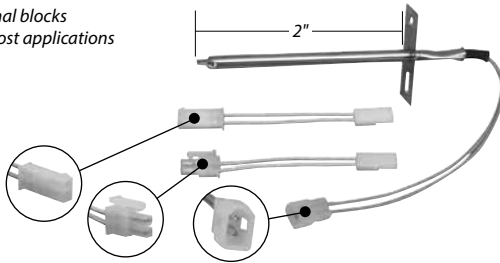

Replaces:  
Whirlpool #12001655

Order No. ER12001656

Oven Probe Kit  
Kit includes two optional blocks  
Fits most applications

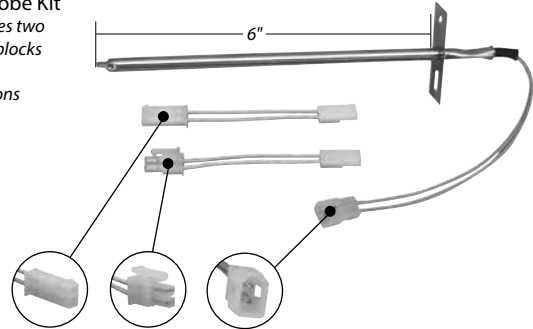

Replaces:  
Whirlpool #12001656

Order No. ER316233902

**NEW!**

Oven Probe

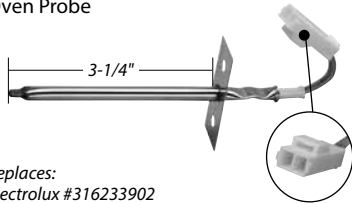

Replaces:  
Electrolux #316233902

Order No. ER8053344

Oven Probe

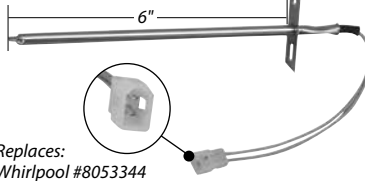

Replaces:  
Whirlpool #8053344

Order No. ERW10181986

**NEW!**

Oven Probe

**PHOTO NOT AVAILABLE  
AT TIME OF PRINTING**

Replaces:  
Whirlpool #W10181986

# DOOR LATCHES & HANDLES

Order No. ERW10107820

Door Latch



Replaces:  
Whirlpool #W10107820

Order No. ERW10107830

Door Latch



Replaces:  
Whirlpool #W10107830

Order No. ER3196113

Solenoid Assembly

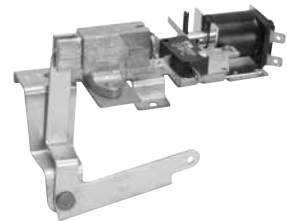

Replaces:  
Whirlpool  
#3196113

Order No. ER316270200

**NEW!**

Oven Door Handle  
29" long x 1-3/8" wide



Replaces:  
Electrolux #316270200

Order No. ER316270201

**NEW!**

Oven Door Handle  
29" long x 1-3/8" wide



Replaces:  
Electrolux #316270201

COOKING

# PRESSURE REGULATORS

## Order No. ERPR1

1/2" x 1/2" NPT  
4"/10" convertible



Replaces:  
Harper Wyman # 4600S0001

## Order No. ERPR2

1/2" x 1/2" NPT  
5"/10" convertible

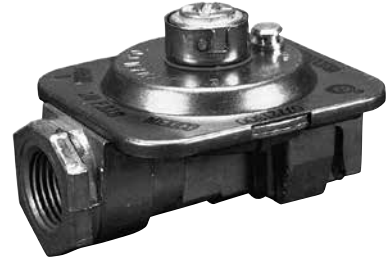

Replaces:  
Harper Wyman # 4600S0002

## Order No. ERPR4

3/4" x 3/4" NPT  
4"/10" convertible



Replaces:  
Harper Wyman # 4600S0004

## Order No. ERPR5

3/4" x 3/4" NPT  
5"/10" convertible



Replaces:  
Harper Wyman # 4600S0005

## Order No. ERPR6

3/4" x 3/4" NPT  
6"/10" convertible



Replaces:  
Harper Wyman # 4600S0006

## Order No. ERPR10

1/2" x 3/8" NPT  
4"/10" convertible  
Includes 3/8" c.c. fine thread  
left hand tubing outlet with  
shutoff



Replaces:  
Harper Wyman # 4600S0010

## Order No. ERPR11

1/2" x 3/8" NPT  
4"/10" convertible  
Includes 3/8" c.c. fine thread male  
tubing outlet with shutoff

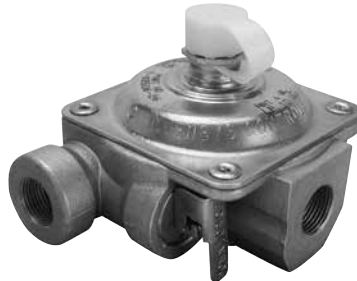

Replaces:  
Harper Wyman # 4600S0011



# PRESSURE REGULATORS

## Pressure Regulator Cross Reference

OEM Part #	ERP #
<b>BROWN</b>	
1801L24 (LP 10")†	ERPR1
1801L33	ERPR1
1801L34 (LP 10")*	ERPR1
1801L43 (LP 10")†	ERPR1
1801L44	ERPR1
1801L45	ERPR2
1801L46 (LP 10")†	ERPR2
1801L49	ERPR1
1801L55	ERPR811
1801L56 (LP 10")†	ERPR811
<b>CHAMBERS</b>	
C305132	ERPR1
<b>DACOR</b>	
82477	ERPR2
82536	ERPR2
82540	ERPR1
<b>DYNAMIC COOKING</b>	
13003	4600S0002
<b>ELECTROLUX</b>	
316054806	ERPR11
316059806*	ERPR11
316091706	ERPR11
316113600*	ERPR1
316416700	ERPR11
318122707	ERPR1
5303016997	ERPR1
5303935125	ERPR11
5308007974	ERPR1
<b>GE/HOTPOINT</b>	
WB2X4844	ERPR2
WB2X4881*	ERPR1
WB19K10004	ERPR1
WB19K27	ERPR10
WB21X465	ERPR1
WB21X516	ERPR1

OEM Part #	ERP #
WB215229*	ERPR2
WB21X5338 (LP 10")†	ERPR1
WB21X5339	ERPR1
<b>HARPER WYMAN</b>	
4670G0031	ERPR1
4670G0078	ERPR2
4670G0089	ERPR2
4670G0099	ERPR6
4673G0005	ERPR5
4673G0010	ERPR4
4742G0005	ERPR1
4742G0006	ERPR2
4742G0014	ERPR4
<b>INVENSYS</b>	
Y68506-26	ERPR11
Y68506-51	ERPR10
<b>KITCHENAID</b> <i>See Whirlpool</i>	
<b>LEEMCO</b>	
A150C12/4-10	ERPR1
A150C12/5-10	ERPR2
A150C34/4-10	ERPR4
<b>MAXITROL</b>	
RV47CL12 4-10	ERPR1
RV47CL12 5-10	ERPR2
<b>MAYTAG</b> <i>See Whirlpool</i>	
<b>PEERLESS PREMIER</b>	
1972	ERPR2
<b>SLATTERY</b>	
02002*	ERPR1
40049*	ERPR4
<b>STAR</b>	
2J-Z0792	ERPR6
<b>THERMADOR</b>	
803815	ERPR1
<b>VIKING</b>	
PA070001	ERPR2

OEM Part #	ERP #
<b>WHIRLPOOL</b>	
0042302*	ERPR1
0069377*	ERPR5
0073930*	ERPR2
3195006	ERPR1
321753*	ERPR1
323023*	ERPR1
324528*	ERPR1
4364159	ERPR2
4364414	ERPR2
4455157	ERPR2
4453033	ERPR2
74006282	ERPR1
74007524 (LP 10")†	ERPR1
7510P00360	ERPR1
7510P00460*	ERPR1
7510P02460*	ERPR1
7510P05360*	ERPR1
7510P05460*	ERPR1
7510P08360	ERPR1
77001246*	ERPR2
98007411	ERPR811
98015762	ERPR811
Y0063684	ERPR2
Y0069636	ERPR1
Y0070976*	ERPR5
Y0088783*	ERPR2
Y02029701*	ERPR2
Y0310244*	ERPR4
Y07721300*	ERPR2
Y704525*	ERPR2
Y704545	ERPR2
Y705894	ERPR2

\* Pressure regulator is NLA from OEM but is still available from ERP.

† Original regulator set for 10" W.C. - cap must be removed from top and inverted to change pressure to L.P. gas setting. Follow the included instruction sheet.

For up-to-date cross reference, go to [www.erparts.com](http://www.erparts.com)

# UNIVERSAL KNOB KITS

ERP's Universal Kit replaces thousands of different knobs for electric and gas ranges. We offer the full selection to replace both surface and thermostat knobs at roughly the same cost as a single exact knob.

## Order No. KN001

Universal Gas Knob Kit  
Kit includes:

**Knobs:** 5

**Inlays:**

4 surface-

CCW to ON/CW to OFF

1 thermostat-

CCW to ON/CW to OFF

**Inserts:** 5 each of

black (.63" high) and white (.40" high)



Replaces: Robertshaw #4590-211, Supco RK203

## Order No. KN002

Universal Electric Knob Kit  
Kit includes:

**Knobs:** 5

**Inlays:**

4 surface CCW, 4 surface CW,

Thermostat 150°-500°

w/ BROIL, 1 CCW to ON,

1 CW to ON

**Inserts:** 5 each of blue, green,

gray, red and yellow



Replaces: Robertshaw #4590-324, Supco RK103

## Order No. KN003

Universal Gas Thermostat  
Knob Kit

Kit includes:

**Knobs:** 1

**Inlays:** 1 thermostat 150°-500°

w/ Broil, CCW to ON / CW to

OFF

**Inserts:** 1 each of

black (.63" high) and  
white (.40" high)



## Order No. KN004

Universal Electric Thermostat Knob Kit  
Kit includes:

**Knobs:** 1

**Inlays:** 1 thermostat 150°-500° w/BROIL,

CCW to ON

1 thermostat 150°-500° w/BROIL,

CW to ON

**Inserts:** 1 each of blue, green,  
gray, red and yellow



Replaces: Robertshaw #4590-324, #4590-339, #4590-526, #4590-724, Supco RK102

## Order No. KN005

Universal Infinite & Oven Knob Kit  
Kit includes:

**Knobs:** 1

**Inlays:** 2 surface-

1 CCW to ON, 1 CW to ON,

1 thermostat 150°-500°

w/BROIL, CCW to ON,

1 thermostat 150°-500°

w/BROIL, CW to ON

**Inserts:** 1 each of blue, green,

gray, red and yellow



Replaces: Supco RK101

## Order No. KN006

Universal Selector Switch Knob Kit  
Kit includes:

**Knob:** 1

**Inlay:** 1 selector - BROIL, BAKE

**Insert:** 1 green



## Order No. KN007

**Commercial Range Burner Knob**  
**Chrome plated metal with set screw**

Replaces: All Points #221013;

Consolidated Commercial Controls #K-133;

Franklin Machine #130-1044;

International Commercial Supply #A-259;

Invensys #40-370; Vulcan Hart #102957, #102957-1,

#113157-1, #2349, #402957, #402957-1, #413157-1



.340

## Order No. ER814362

Universal Knob Kit

9 knobs allow update for complete range.

Replaces #330169, #330170, #330171, #330172, #330173, #330175, #330176,  
#330177, #330178, #330180



Replaces: Supco RK362, Whirlpool #814362

## Order No. KN008

**Commercial Range Burner Knob**  
**Red enamel finished metal with set screw**

Replaces: All Points #221432;

Franklin Machine #130-1084;

International Commercial Supply #A-3914;

Invensys #40-378; Vulcan Hart #102957-2, #102958,

#1954400, #402957-2, #402958, #819544



.340

# KNOBS

KNOBS ARE SHOWN IN SEQUENTIAL PART NUMBER ORDER, "D" POSITION IS WHEN KNOB IS VIEWED FROM BACK IN OFF POSITION  
 "ALSO FITS" ARE FUNCTIONAL REPLACEMENTS; GRAPHIC OR COSMETICS MAY BE DIFFERENT

**BROWN**

Order No. ER1802A247

Thermostat Knob  
(flush shaft)

.340



Order No. ER1802A248

Burner Knob  
(flush shaft)

.340



Order No. ER1802A295

Thermostat Knob  
(1/8" extended shaft)

.256



Order No. ER1802A331

Thermostat Knob  
(flush shaft)

.340



Order No. ER1802A332

Thermostat Knob  
(3/16" extended shaft)

.256



Order No. ER1802A333

Thermostat Knob  
(1/8" extended shaft)

.256



Order No. ER1802A342

Thermostat Knob  
(3/16" extended shaft)

.256



Order No. ER1802A343

Thermostat Knob  
(1/8" extended shaft)

.256



Order No. ER1805D129

Burner Knob  
(5/16" extended shaft)

.340



Order No. ER1805D130

Burner Knob  
(5/16" extended shaft)

.340



Order No. ER1805D135

Burner Knob  
(5/16" extended shaft)

.340



Order No. ER1805D137

Burner Knob  
(3/16" extended shaft)

.256



Order No. ER1805D141

Burner Knob  
(3/16" extended shaft)

.256



Order No. ER1842A40

Thermostat Knob  
(flush shaft)

.256



Electric

Order No. ER1842A58

Thermostat Knob  
(flush shaft)

.256



Electric

\* SEE PAGE 92-93 FOR ADDITIONAL CROSS REFERENCE \*

# KNOBS

KNOBS ARE SHOWN IN SEQUENTIAL PART NUMBER ORDER, "D" POSITION IS WHEN KNOB IS VIEWED FROM BACK IN OFF POSITION  
 "ALSO FITS" ARE FUNCTIONAL REPLACEMENTS; GRAPHIC OR COSMETICS MAY BE DIFFERENT

**Order No. ER1842A60**

Thermostat Knob  
(flush shaft)

**NEW!**

Electric

**Order No. ER1845D33**

Infinite Knob  
(flush shaft)

.256

Electric

**Order No. ER1845D40**

Infinite Knob  
(flush shaft)

.256

Electric

**Order No. ER1845D41**

Infinite Knob  
(flush shaft)

**NEW!**

Electric

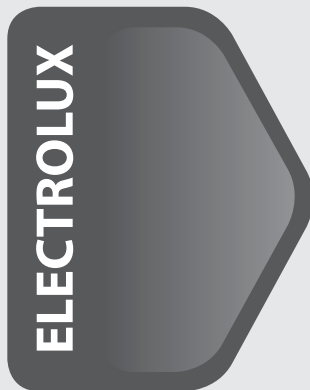

**Order No. ER7331**

Thermostat Knob  
(flush shaft)

.340

NLA from OEM

**Order No. ER3131202**

Thermostat Knob  
(1/2" extended shaft)

.340

**Order No. ER3200539**

Infinite Knob  
(flush shaft)

NLA from OEM

Electric

**Order No. ER3204880**

Thermostat Knob  
(1/16" extended shaft)

.256

Also fits: 5303304808

**Order No. ER316009008**

Burner Knob  
(5/8" extended shaft)

.340

**Order No. ER316009009**

Burner Knob  
(5/8" extended shaft)

.340

**Order No. ER316009107**

Thermostat Knob  
(1/16" extended shaft)

.256

**Order No. ER316009113**

Thermostat Knob  
(1/16" extended shaft)

.340

**Order No. ER316009115**

Thermostat Knob  
(1/2" extended shaft)

.340

**Order No. ER316009117**

Thermostat Knob  
(flush shaft)

Electric

**Order No. ER316016819**

Thermostat Knob  
(5/16" extended shaft)

NLA from OEM

Electric

\* SEE PAGE 92-93 FOR ADDITIONAL CROSS REFERENCE \*

# KNOBS

KNOBS ARE SHOWN IN SEQUENTIAL PART NUMBER ORDER, "D" POSITION IS WHEN KNOB IS VIEWED FROM BACK IN OFF POSITION  
 "ALSO FITS" ARE FUNCTIONAL REPLACEMENTS; GRAPHIC OR COSMETICS MAY BE DIFFERENT

Order No. ER316023009

Burner Knob  
 (5/8" extended shaft)

.340



Order No. ER316023020

Burner Knob  
 (5/8" extended shaft)

.340



Order No. ER316023023

Burner Knob  
 (5/8" extended shaft)

.340



Order No. ER316025106

Infinite Knob  
 (flush shaft)

.256



Order No. ER316025108

Infinite Knob  
 (flush shaft)

.256



Order No. ER316029008

Clock Knob  
 (flush shaft)



Order No. ER316102300

Thermostat Knob  
 (1/16" extended shaft)

.256



Order No. ER316102303

Thermostat Knob  
 (flush shaft)

.256



Order No. ER316102304

Thermostat Knob  
 (1/2" extended shaft)

.340



Order No. ER316102306

Thermostat Knob  
 (1/2" extended shaft)

.340



Order No. ER316108902

Infinite Knob  
 (flush shaft)

.256



Electric

Order No. ER316108917

Infinite Knob  
 (5/16" extended shaft)

.256



Electric

Order No. ER316109002

Burner Knob  
 (3/8" extended shaft)

.340



Order No. ER316109003

Thermostat Knob  
 (1/2" extended shaft)

.340



Order No. ER316109512

Burner Knob  
 (3/8" extended shaft)

.340



Order No. ER316109514

Burner Knob  
 (3/8" extended shaft)

.340



\* SEE PAGE 92-93 FOR ADDITIONAL CROSS REFERENCE \*



# KNOBS

KNOBS ARE SHOWN IN SEQUENTIAL PART NUMBER ORDER, "D" POSITION IS WHEN KNOB IS VIEWED FROM BACK IN OFF POSITION  
 "ALSO FITS" ARE FUNCTIONAL REPLACEMENTS; GRAPHIC OR COSMETICS MAY BE DIFFERENT

Order No. ER316109515

Burner Knob  
 (3/8" extended shaft) **.340**



Order No. ER316123303

Infinite Knob  
 (3/8" extended shaft) **.256**

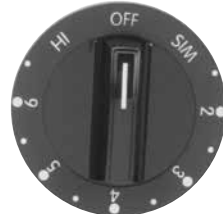

Electric

Order No. ER316123304

Thermostat Knob  
 (3/8" extended shaft) **.340**



Electric

Order No. ER316220002

Burner Knob  
 (1/2" extended shaft) **.340**



Order No. ER316220009

Burner Knob  
 (3/8" extended shaft) **.256**



**NEW!**

Order No. ER316240700

Burner Knob  
 (3/8" extended shaft) **.340**



Order No. ER316240802

Infinite Knob  
 (flush shaft) **.256**



**NEW!**

Order No. ER318016209

Burner Knob  
 (5/16" extended shaft) **.340**



Order No. ER318016823

Thermostat Knob  
 (flush shaft) **.256**



Order No. ER318099100

Burner Knob  
 (3/4" extended shaft) **.340**



Order No. ER318196201

Burner Knob  
 (3/4" extended shaft) **.340**



Order No. ER5303051028

Infinite Knob  
 (flush shaft) **.340**



Electric

Order No. ER5303051030

Thermostat Knob  
 (flush shaft) **.340**



NLA  
 from  
 OEM

Order No. ER5303051405

Infinite Knob  
 (5/8" extended shaft) **.256**

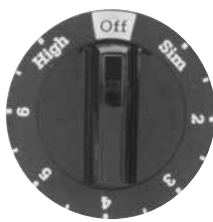

Electric

Order No. ER5303131018

Thermostat Knob  
 (3/8" extended shaft) **.340**



Order No. ER5303211140

Thermostat Knob  
 (1/2" extended shaft) **.340**



\* SEE PAGE 92-93 FOR ADDITIONAL CROSS REFERENCE \*

# KNOBS

KNOBS ARE SHOWN IN SEQUENTIAL PART NUMBER ORDER, "D" POSITION IS WHEN KNOB IS VIEWED FROM BACK IN OFF POSITION  
 "ALSO FITS" ARE FUNCTIONAL REPLACEMENTS; GRAPHIC OR COSMETICS MAY BE DIFFERENT

Order No. ER5303271670

Burner Knob  
 (5/8" extended shaft)

.340



Order No. ER5303272301

Thermostat Knob  
 (flush shaft)

.256



Order No. ER5303284698

Burner Knob  
 (5/8" extended shaft)

.340



Order No. ER5303285724

Thermostat Knob  
 (flush shaft)

.340



Order No. ER5303285939

Infinite Knob  
 (flush shaft)

.256



Electric

Order No. ER5303285940

Thermostat Knob  
 (flush shaft)

.256



Electric

Order No. ER5303288194

Thermostat Knob  
 (flush shaft)

.256



Order No. ER5303297131

Thermostat Knob  
 (1/2" extended shaft)

.340



Order No. ER5303302473

Thermostat Knob  
 (flush shaft)

.256



Order No. ER5303303405

Burner Knob  
 (5/8" extended shaft)

.340



Order No. ER5303303406

Burner Knob  
 (5/8" extended shaft)

.340



Order No. ER5303303408

Thermostat Knob  
 (1/16" extended shaft)

.256



Order No. ER5303303673

Burner Knob  
 (5/8" extended shaft)

.340



Order No. ER5303304242

Burner Knob  
 (5/8" extended shaft)

.340



Order No. ER5303304506

Infinite Knob  
 (flush shaft)

.256



Order No. ER5303305604

Infinite Knob  
 (flush shaft)

.256



Also fits Electrolux #316102307

\* SEE PAGE 92-93 FOR ADDITIONAL CROSS REFERENCE \*

All logos, trademarks, part numbers, photos & illustrations are intended solely for identification.  
 Items offered for sale are not represented to be manufactured by the company that built the original equipment.

# KNOBS

KNOBS ARE SHOWN IN SEQUENTIAL PART NUMBER ORDER, "D" POSITION IS WHEN KNOB IS VIEWED FROM BACK IN OFF POSITION  
 "ALSO FITS" ARE FUNCTIONAL REPLACEMENTS; GRAPHIC OR COSMETICS MAY BE DIFFERENT

Order No. ER5303323278

Burner Knob  
 (5/16" extended shaft) **.340**



Order No. ER5308013889

Burner Knob  
 (1/2" extended shaft) **.340**



Order No. ER5308013896

Thermostat Knob  
 (5/16" extended shaft) **.340**



Order No. ER5308013898

Burner Knob  
 (3/16" extended shaft) **.340**



Also fits Whirlpool #327374, #4335263

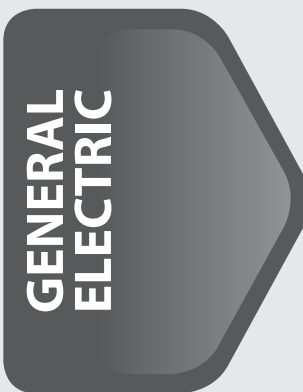

Order No. ERWB3K100

Burner Knob  
 (5/16" extended shaft) **.256**



Order No. ERWB3K5069

Infinite Knob  
 (flush shaft)



Electric  
 Also fits Whirlpool #4333759

Order No. ERWB3K5097

Burner Knob  
 (1/16" extended shaft) **.340**



Also fits Whirlpool #338449, #4342557

Order No. ERWB3K5098

Thermostat Knob  
 (flush shaft) **.340**



NLA  
 from  
 OEM

Order No. ERWB3K5265

Burner Knob  
 (3/8" extended shaft) **.256**



Order No. ERWB03K10006

Thermostat Knob  
 (1/2" extended shaft) **.340**



Order No. ERWB03K10007

Burner Knob  
 (5/16" extended shaft) **.256**



Order No. ERWB03K10034

Burner Knob  
 (5/16" extended shaft) **.256**



Order No. ERWB03K10035

Burner Knob  
 (5/16" extended shaft) **.256**



Order No. ERWB03K10036

Thermostat Knob  
 (1/2" extended shaft) **.256**



Order No. ERWB03K10053

Thermostat Knob  
 (flush shaft) **.375**



\* SEE PAGE 92-93 FOR ADDITIONAL CROSS REFERENCE \*

# KNOBS

KNOBS ARE SHOWN IN SEQUENTIAL PART NUMBER ORDER, "D" POSITION IS WHEN KNOB IS VIEWED FROM BACK IN OFF POSITION  
 "ALSO FITS" ARE FUNCTIONAL REPLACEMENTS; GRAPHIC OR COSMETICS MAY BE DIFFERENT

Order No. ERWB03K10067

Thermostat Knob  
 (1/2" extended shaft) **.340**



Order No. ERWB03K10084

Infinite Knob  
 (flush shaft) **.256**



Electric

Order No. ERWB03K10141

Burner Knob  
 (5/16" extended shaft) **.256**



Order No. ERWB03K10149

Thermostat Knob  
 (1/8" extended shaft) **.256**



Electric

Order No. ERWB03K10201

Infinite Knob  
 (flush shaft) **.256**



**NEW!**

Order No. ERWB03K10204

Thermostat Knob  
 (1/2" extended shaft) **.256**



**NEW!**

Order No. ERWB03K10302

Thermostat Knob  
 (1/8" extended shaft) **.256**



**NEW!**

Order No. ERWB03K10303

Burner Knob  
 (1/2" extended shaft) **.256**



**NEW!**

Order No. ERWB36K10126

Burner Knob  
 (5/16" extended shaft) **.256**



Order No. ERWB3M26

Infinite Knob  
 (flush shaft) **.256**

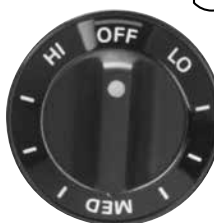

Electric

Order No. ERWB03T10072

Infinite Knob  
 (flush shaft) **.256**

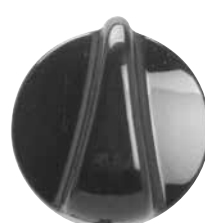

Electric

Order No. ERWB03T10076

Infinite Knob  
 (flush shaft) **.256**



Electric - white color

Order No. ERWB03T10129

Infinite Knob  
 (flush shaft) **.256**



Electric - biscuit color

Order No. ERWB03T10134

Burner Knob  
 (3/8" extended shaft) **.340**



Order No. ERWB03T10171

Burner Knob  
 (3/8" extended shaft) **.256**



**NEW!**

Order No. ERWB03T10207

Infinite Knob  
 (flush shaft) **.256**



**NEW!**

\* SEE PAGE 92-93 FOR ADDITIONAL CROSS REFERENCE \*

# KNOBS

KNOBS ARE SHOWN IN SEQUENTIAL PART NUMBER ORDER, "D" POSITION IS WHEN KNOB IS VIEWED FROM BACK IN OFF POSITION  
 "ALSO FITS" ARE FUNCTIONAL REPLACEMENTS; GRAPHIC OR COSMETICS MAY BE DIFFERENT

Order No. ERWB3X464

Infinite Knob  
 (1/8" extended shaft)

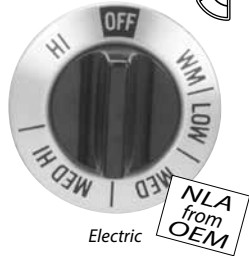

Electric

NLA  
 from  
 OEM

Order No. ERWB3X474

Infinite Knob  
 (1/8" extended shaft)



Electric

NLA  
 from  
 OEM

Order No. ERWB3X694

Thermostat Knob  
 (flush shaft)



.256

Order No. ERWB3X712

Burner Knob  
 (5/8" extended shaft)



.340

Also fits Electrolux #3131306

Order No. ERWB3X714

Burner Knob  
 (5/8" extended shaft)



.340

Order No. ERWB3X716

Thermostat Knob  
 (1/2" extended shaft)



.340

Order No. ERWB3X745

Burner Knob  
 (flush shaft)



.340

Order No. ERWB3X800

Infinite Knob  
 (flush shaft)



Electric

Order No. ERWB3X5699

Clock Knob  
 (3 pack)



.340

Order No. ERWB3X5746

Thermostat Knob  
 (flush shaft)



Electric

.340

Order No. ERWB3X5856

Thermostat Knob  
 (flush shaft)



.340

Order No. ERWB3X5857

Burner Knob  
 (5/16" extended shaft)



.340

NLA  
 from  
 OEM

Order No. ERWB3X5858

Thermostat Knob  
 (flush shaft)



Electric

.256

Order No. ERWB3X5859

Infinite Knob  
 (flush shaft)

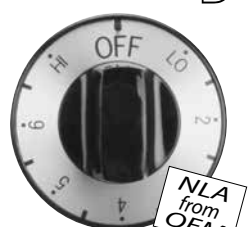

Electric

.256

NLA  
 from  
 OEM

Order No. ERWB03X10030

Infinite Knob  
 (1/8" extended shaft)

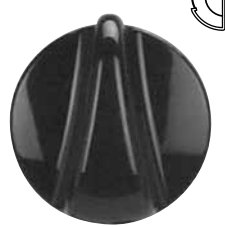

Electric

.256

Order No. ERWB03X10262

Thermostat Knob  
 (flush shaft)



.256

NEW!

\* SEE PAGE 92-93 FOR ADDITIONAL CROSS REFERENCE \*

All logos, trademarks, part numbers, photos & illustrations are intended solely for identification.  
 Items offered for sale are not represented to be manufactured by the company that built the original equipment.



# KNOBS

KNOBS ARE SHOWN IN SEQUENTIAL PART NUMBER ORDER, "D" POSITION IS WHEN KNOB IS VIEWED FROM BACK IN OFF POSITION  
 "ALSO FITS" ARE FUNCTIONAL REPLACEMENTS; GRAPHIC OR COSMETICS MAY BE DIFFERENT

Order No. ERWB03X10272

Burner Knob  
 (5/16" extended shaft) .340



Order No. ERWB03X10273

Thermostat Knob  
 (flush shaft) .340



Order No. ERWB03X10274

Thermostat Knob  
 (1/16" extended shaft) .340



Order No. ERWB03X10275

Thermostat Knob  
 (flush shaft) .256



Order No. ERWB03X10276

Infinite Knob  
 (flush shaft) .256

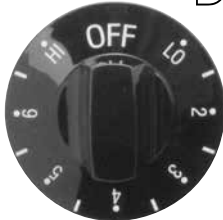

Electric



Order No. ER6251MW

Thermostat Knob  
 (1/8" recessed shaft) .340



Order No. ER6253

Thermostat Knob  
 (flush shaft) .340



Also fits Whirlpool #4364126

Order No. ER6255

Thermostat Knob  
 (flush shaft) .340



Order No. ER6255W

Thermostat Knob  
 (flush shaft) .340



Order No. ER6280MW

Burner Knob  
 (flush shaft) .340



Order No. ER6284

Burner Knob  
 (flush shaft) .256



Also fits Whirlpool #4364129

Order No. ER6286

Burner Knob  
 (flush shaft) .256



Order No. ER6286W

Burner Knob  
 (flush shaft) .256



Order No. ER6376

Thermostat Knob  
 (1/8" recessed shaft) .256



Electric

Order No. ER6376W

Thermostat Knob  
 (1/8" recessed shaft) .256



Electric

\* SEE PAGE 92-93 FOR ADDITIONAL CROSS REFERENCE \*



# KNOBS

KNOBS ARE SHOWN IN SEQUENTIAL PART NUMBER ORDER, "D" POSITION IS WHEN KNOB IS VIEWED FROM BACK IN OFF POSITION  
 "ALSO FITS" ARE FUNCTIONAL REPLACEMENTS; GRAPHIC OR COSMETICS MAY BE DIFFERENT

Order No. ER6476

Infinite Knob  
 (1/8" recessed shaft) .256



Electric

Order No. ER6476W

Infinite Knob  
 (1/8" recessed shaft) .256



Electric



Order No. ER0057299

Thermostat Knob  
 (1/8" extended shaft) .256



**NEW!**

Order No. ER0057300

Infinite Knob  
 (flush shaft) .256



NLA  
 from  
 OEM

Order No. ER07515700

Burner Knob  
 (1/8" extended shaft) .340



NLA  
 from  
 OEM

Order No. ER307458

Infinite Knob  
 (1/16" extended shaft) .256



Electric

Order No. ER309563B

Burner Knob  
 (5/16" extended shaft) .340



Order No. ER3149983

Infinite Knob  
 (1/16" extended shaft) .256



Electric

Order No. ER3149984

Selector Knob  
 (1/16" extended shaft) .256



Electric

Order No. ER3149986

Burner Knob  
 (1/16" extended shaft) .256



Electric

Order No. ER3149987

Thermostat Knob  
 (1/16" extended shaft) .256



Electric

Order No. ER3149988

Thermostat Knob  
 (1/16" extended shaft) .256



Electric

Order No. ER3182567

Burner Knob  
 (3/8" extended shaft) .340



Order No. ER3196027

Infinite Knob  
 (1/8" extended shaft) .256



Electric

Order No. ER3196213

Thermostat Knob  
 (1/8" extended shaft) .256

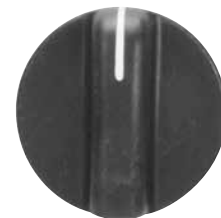

Electric

\* SEE PAGE 92-93 FOR ADDITIONAL CROSS REFERENCE \*

# KNOBS

KNOBS ARE SHOWN IN SEQUENTIAL PART NUMBER ORDER, "D" POSITION IS WHEN KNOB IS VIEWED FROM BACK IN OFF POSITION  
 "ALSO FITS" ARE FUNCTIONAL REPLACEMENTS; GRAPHIC OR COSMETICS MAY BE DIFFERENT

<p><b>Order No. ER3196214</b></p> <p>Thermostat Knob (1/8" extended shaft)</p>  <p><b>NEW!</b></p> <p>Electric</p>	<p><b>Order No. ER3196231</b></p> <p>Infinite Knob (1/8" extended shaft)</p>  <p>Electric</p>	<p><b>Order No. ER3196232</b></p> <p>Infinite Knob (1/8" extended shaft)</p>  <p>Electric</p>	<p><b>Order No. ER330190</b></p> <p>Infinite Knob (flush shaft)</p>  <p>Electric</p>
<p><b>Order No. ER4179282</b></p> <p>Burner Knob (1/8" extended shaft)</p>  <p>.340</p>	<p><b>Order No. ER4179304</b></p> <p>Infinite Knob (flush shaft)</p>  <p>.256</p> <p>Electric</p>	<p><b>Order No. ER4179305</b></p> <p>Thermostat Knob (flush shaft)</p>  <p>.256</p> <p>Electric Also fits Maytag #Y07517601</p> <p>NLA from OEM</p>	<p><b>Order No. ER4315513</b></p> <p>Infinite Knob (flush shaft)</p>  <p>.256</p> <p>Electric Also fits Maytag #Y0311518</p>
<p><b>Order No. ER4315516</b></p> <p>Burner Knob (1/8" extended shaft)</p>  <p>.340</p>	<p><b>Order No. ER4327244</b></p> <p>Burner Knob (flush shaft)</p>  <p>.340</p> <p>NLA from OEM Also fits GE #293337</p>	<p><b>Order No. ER4333767</b></p> <p>Thermostat Knob (5/16" extended shaft)</p>  <p>.340</p> <p>NLA from OEM</p>	<p><b>Order No. ER4371476</b></p> <p>Burner Knob (5/8" extended shaft)</p>  <p>.340</p> <p>NLA from OEM Also fits Electrolux #5303284698</p>
<p><b>Order No. ER4371492</b></p> <p>Burner Knob (5/8" extended shaft)</p>  <p>.340</p> <p>NLA from OEM</p>	<p><b>Order No. ER4371663</b></p> <p>Burner Knob (5/8" extended shaft)</p>  <p>.340</p> <p>Also fits Electrolux #5303304242</p>	<p><b>Order No. ER4372287</b></p> <p>Thermostat Knob (flush shaft)</p>  <p>.256</p>	<p><b>Order No. ER4372386</b></p> <p>Thermostat Knob (1/2" extended shaft)</p>  <p>.340</p>

\* SEE PAGE 92-93 FOR ADDITIONAL CROSS REFERENCE \*

# KNOBS

KNOBS ARE SHOWN IN SEQUENTIAL PART NUMBER ORDER, "D" POSITION IS WHEN KNOB IS VIEWED FROM BACK IN OFF POSITION  
 "ALSO FITS" ARE FUNCTIONAL REPLACEMENTS; GRAPHIC OR COSMETICS MAY BE DIFFERENT

Order No. ER71001641

Burner Knob  
 (5/8" extended shaft)

.340



**NEW!**

Order No. ER74002352

Thermostat Knob  
 (flush shaft)

.256



Order No. ER74002353

Thermostat Knob  
 (3/8" extended shaft)

.256



Order No. ER74002444

Thermostat Knob  
 (flush shaft)

.256



Order No. ER74002445

Burner Knob  
 (3/8" extended shaft)

.256



Order No. ER74003280

Burner Knob  
 (flush shaft)

.256



Electric

Order No. ER74003296

Thermostat Knob  
 (1/8" extended shaft)

.340

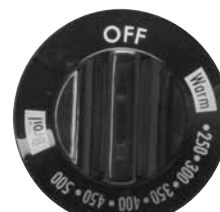

Order No. ER74003297

Burner Knob  
 (1/8" extended shaft)

.256



Order No. ER74003712

Burner Knob  
 (flush shaft)

.256



NLA  
 from  
 OEM

Also fits Whirlpool #74003611

Order No. ER74003713

Burner Knob  
 (flush shaft)

.256



NLA  
 from  
 OEM

Also fits Whirlpool #74003612

Order No. ER74003909

Thermostat Knob  
 (flush shaft)

.256



Order No. ER74007733

Burner Knob  
 (1/4" extended shaft)

.256



**NEW!**

Order No. ER74007918

Burner Knob  
 (1/2" extended shaft)

.256



Order No. ER74009773

Burner Knob  
 (1/4" extended shaft)

.256



**NEW!**

Order No. ER74010132

Thermostat Knob  
 (3/4" extended shaft)

.340



**NEW!**

Order No. ER74010839

Burner Knob  
 (1/4" extended shaft)

.256



**NEW!**

\* SEE PAGE 92-93 FOR ADDITIONAL CROSS REFERENCE \*

# KNOBS

KNOBS ARE SHOWN IN SEQUENTIAL PART NUMBER ORDER, "D" POSITION IS WHEN KNOB IS VIEWED FROM BACK IN OFF POSITION  
 "ALSO FITS" ARE FUNCTIONAL REPLACEMENTS; GRAPHIC OR COSMETICS MAY BE DIFFERENT

Order No. ER74011260

Burner Knob  
 (1/2" extended shaft) **.256**



**NEW!**

Order No. ER74011287

Burner Knob  
 (1/4" extended shaft) **.256**



**NEW!**

Also fits Whirlpool #74007794

Order No. ER7711P13560

Burner Knob  
 (1/4" extended shaft) **.340**



Order No. ER7711P15260

Thermostat Knob  
 (1/8" extended shaft) **.340**



Order No. ER7711P31160

Thermostat Knob  
 (flush shaft) **.256**



Electric

Order No. ER7711P31460

Infinite Knob  
 (flush shaft) **.256**



Electric

Order No. ER7711P39460

Thermostat Knob  
 (1/8" extended shaft) **.340**



NLA  
 from  
 OEM

Order No. ER7731P01360

Thermostat Knob  
 (flush shaft) **.340**



Order No. ER7731P04060

Thermostat Knob  
 (flush shaft) **.256**



NLA  
 from  
 OEM

Order No. ER7731P09460

Thermostat Knob  
 (1/4" extended shaft) **.340**



NLA  
 from  
 OEM

Order No. ER7733P01460

Burner Knob  
 (flush shaft) **.340**



NLA  
 from  
 OEM

Order No. ER7733P01560

Burner Knob  
 (flush shaft) **.340**



Order No. ER7733P02760

Burner Knob  
 (1/4" extended shaft) **.340**



NLA  
 from  
 OEM

Order No. ER7733P06260

Burner Knob  
 (1/4" extended shaft) **.340**



NLA  
 from  
 OEM

Order No. ER7733P072-60

Burner Knob  
 (flush shaft) **.340**



**NEW!**

Order No. ER7739P048-60

Selector Knob  
 (flush shaft) **.256**



**NEW!**

\* SEE PAGE 92-93 FOR ADDITIONAL CROSS REFERENCE \*

All logos, trademarks, part numbers, photos & illustrations are intended solely for identification.  
 Items offered for sale are not represented to be manufactured by the company that built the original equipment.

# KNOBS

KNOBS ARE SHOWN IN SEQUENTIAL PART NUMBER ORDER, "D" POSITION IS WHEN KNOB IS VIEWED FROM BACK IN OFF POSITION  
 "ALSO FITS" ARE FUNCTIONAL REPLACEMENTS; GRAPHIC OR COSMETICS MAY BE DIFFERENT

**Order No. ER8053595**

Burner Knob  
 (1/8" extended shaft) **.340**

**Order No. ER8272762**

Burner Knob  
 (1/16" extended shaft) **.340**

**Order No. ER8272765**

Burner Knob  
 (1/8" extended shaft) **.256**

**Order No. ER8272802**

Infinite Knob  
 (1/16" extended shaft)

Electric

**Order No. ER8273103**

Burner Knob  
 (1/8" extended shaft) **.256**

**Order No. ER8273104**

Burner Knob  
 (1/8" extended shaft) **.256**

**Order No. ER8273111**

Burner Knob  
 (1/8" extended shaft) **.256**

**Order No. ER8273115**

Burner Knob  
 (1/8" extended shaft) **.256**

**Order No. ER8273116**

Burner Knob  
 (1/8" extended shaft) **.256**

**Order No. ER8286034BL**

Infinite Knob  
 (flush shaft)

**NEW!**

**Order No. ER9761962**

Infinite Knob  
 (1/8" extended shaft)

**NEW!**

**Order No. ER98006102**

Burner Knob  
 (1/8" extended shaft) **.256**

**Order No. ER98006104**

Burner Knob  
 (1/4" extended shaft) **.256**

**Order No. ER98008321**

Thermostat Knob  
 (3/8" extended shaft) **.256**

**NEW!**

**Order No. ERY0055029**

Thermostat Knob  
 (flush shaft) **.340**

**Order No. ERY0057293**

Thermostat Knob  
 (flush shaft) **.340**

Also fits GE #WB3X5648, #WB3X652

\* SEE PAGE 92-93 FOR ADDITIONAL CROSS REFERENCE \*



# KNOBS

KNOBS ARE SHOWN IN SEQUENTIAL PART NUMBER ORDER, "D" POSITION IS WHEN KNOB IS VIEWED FROM BACK IN OFF POSITION  
 "ALSO FITS" ARE FUNCTIONAL REPLACEMENTS; GRAPHIC OR COSMETICS MAY BE DIFFERENT

Order No. ERY0089057

Thermostat Knob  
 (flush shaft)

.340

NLA  
 from  
 OEM



Order No. ERY0310525

Thermostat Knob  
 (flush shaft)

.340



Order No. ERY0310526

Infinite Knob  
 (flush shaft)

.256

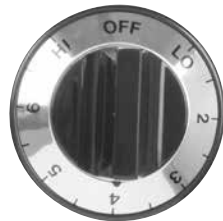

Order No. ERY0310527

Thermostat Knob  
 (flush shaft)

.256



Order No. ERY07440901

Burner Knob  
 (flush shaft)

.340

NLA  
 from  
 OEM



Order No. ERY07506601

Thermostat Knob  
 (flush shaft)

.340



Order No. ERY07507301

Burner Knob  
 (1/8" extended shaft)

.340



Order No. ERY07589200

Burner Knob  
 (1/8" extended shaft)

.340



Order No. ERY07708202

Burner Knob  
 (1/8" extended shaft)

.340



Order No. ERY700854

Burner Knob  
 JENN-AIR (flush shaft)

.256



Electric

\* SEE PAGE 92-93 FOR ADDITIONAL CROSS REFERENCE \*

All logos, trademarks, part numbers, photos & illustrations are intended solely for identification.  
 Items offered for sale are not represented to be manufactured by the company that built the original equipment.



# KNOBS

## KNOB CROSS REFERENCE

OEM Part #	ERP #	PG
<b>AMANA</b> <i>See Whirlpool</i>		
<b>BROWN</b>		
1802A247	ER1802A247	77
1802A248	ER1802A248	77
1802A295	ER1802A295	77
1802A331	ER1802A331	77
1802A332	ER1802A332	77
1802A333	ER1802A333	77
1802A342	ER1802A342	77
1802A343	ER1802A343	77
1805D129	ER1805D129	77
1805D130	ER1805D130	77
1805D135	ER1802D135	77
1805D137	ER1805D137	77
1805D141	ER1805D141	77
1842A40	ER1842A40	77
1842A58	ER1842A58	77
1842A60	ER1842A60	78
1845D33	ER1845D33	78
1845D40	ER1845D40	78
1845D41	ER1845D41	78
<b>ELECTROLUX</b>		
3131202*	ER3131202	78
3131306*	ERWB3X712	84
316009008	ER316009008	78
316009009*	ER316009009	78
316009107*	ER316009107	78
316009113	ER316009113	78
316009115	ER316009115	78
316009117	ER316009117	78
316016819*	ER316016819	78
316023009	ER316023009	79
316023020	ER316023020	79
316023023	ER316023023	79
316025106	ER316025106	79
316025108	ER316025108	79
316029008	ER316029008	79
316102300	ER316102300	79
316102303	ER316102303	79

OEM Part #	ERP #	PG
316102304	ER316102304	79
316102306	ER316102306	79
316102307	ER5303305604	81
316108902	ER316108902	79
316108917	ER316108917	79
316109002	ER316109002	79
316109003	ER316109003	79
316109511*	ER316109515	80
316109512	ER316109512	79
316109514	ER316109514	79
316109515	ER316109515	80
316123300	ER316016819	78
316123303	ER316123303	80
316123304	ER316123304	80
316220002	ER316220002	80
316220009	ER316220009	80
316240700	ER316240700	80
316240802	ER316240802	80
318016209	ER318016209	80
318016816*	ER318016823	80
318016823	ER318016823	80
318099100	ER318099100	80
318196201	ER318196201	80
3200539*	ER3200539	78
3204880	ER3204880	78
5300227455	ER5308013889	82
5303051028	ER5303051028	80
5303051030*	ER5303051030	80
5303051405	ER5303051405	80
5303131018	ER5303131018	80
5303210272	ER316009117	78
5303211140	ER5303211140	80
5303271670	ER5303271670	81
5303272301	ER5303272301	81
5303280587	ER316102304	79
5303284698	ER5303284698	81
5303285724	ER5303285724	81
5303285939	ER5303285939	81
5303285940	ER5303285940	81

OEM Part #	ERP #	PG
5303288194	ER5303288194	81
5303297131	ER5303297131	81
5303302473	ER5303302473	81
5303303405	ER5303303405	81
5303303406	ER5303303406	81
5303303408	ER5303303408	81
5303303673	ER5303303673	81
5303304242	ER5303304242	81
5303304506	ER5303304506	81
5303304808*	ER3204880	78
5303305604	ER5303305604	81
5303323278	ER5303323278	82
5308013889*	ER5308013889	82
5308013896*	ER5308013896	82
5308013898	ER5308013898	82
7331*	ER7331	78
<b>GE/HOTPOINT</b>		
293337*	ER4327244	87
WB03K10006	ERWB03K10006	82
WB03K10007	ERWB03K10007	82
WB03K10034	ERWB03K10034	82
WB03K10035	ERWB03K10035	82
WB03K10036	ERWB03K10036	82
WB03K10053	ERWB03K10053	82
WB03K10061	ERWB03K10061	82
WB03K10067	ERWB03K10067	83
WB03K10084	ERWB03K10084	83
WB03K10141	ERWB03K10141	83
WB03K10149	ERWB03K10149	83
WB03K10201	ERWB03K10201	83
WB03K10204	ERWB03K10204	83
WB03K10302	ERWB03K10302	83
WB03K10303	ERWB03K10303	83
WB3K100	ERWB3K100	82
WB3K5069	ERWB3K5069	82
WB3K5097	ERWB3K5097	82
WB3K5098*	ERWB3K5098	82
WB3K5265	ERWB3K5265	82
WB36K10126	ERWB36K10126	83

OEM Part #	ERP #	PG
WB3M26	ERWB3M26	83
WB03T10072	ERWB03T10072	83
WB03T10076	ERWB03T10076	83
WB03T10129	ERWB03T10129	83
WB03T10134	ERWB03T10134	83
WB03T10171	ERWB03T10171	83
WB03T10207	ERWB03T10207	83
WB03X10030	ERWB03X10030	84
WB03X10262	ERWB03X10262	84
WB03X10272	ERWB03X10272	85
WB03X10273	ERWB03X10273	85
WB03X10274	ERWB03X10274	85
WB03X10275	ERWB03X10275	85
WB03X10276	ERWB03X10276	85
WB3X464	ERWB3X464	84
WB3X474*	ERWB3X474	84
WB3X652*	ERY0057293	90
WB3X694	ERWB3X694	84
WB3X712	ERWB3X712	84
WB3X713	ER5303303406	81
WB3X714	ERWB3X714	84
WB3X716	ERWB3X716	84
WB3X745	ERWB3X745	84
WB3X760*	ER4179282	87
WB3X800	ERWB3X800	84
WB3X5647*	ER4179282	87
WB3X5684	ERWB3X474	84
WB3X5699	ERWB3X5699	84
WB3X5746	ERWB3X5746	84
WB3X5856	ERWB3X5856	84
WB3X5857*	ERWB3X5857	84
WB3X5858	ERWB3X5858	84
WB3X5859*	ERWB3X5859	84
<b>MAGIC CHEF</b> <i>See Whirlpool</i>		
<b>MAYTAG</b> <i>See Whirlpool</i>		
<b>PEERLESS PREMIER</b>		
6251MW	ER6251MW	85
6253	ER6253	85
6255	ER6255	85

\* Knob is NLA from OEM - still available at ERP

For up-to-date cross reference, go to [www.erparts.com](http://www.erparts.com)

## KNOB CROSS REFERENCE

OEM Part #	ERP #	PG
6255W	ER6255W	85
6280MW	ER6280MW	85
6284	ER6284	85
6286	ER6286	85
6286W	ER6286W	85
6376	ER6376	85
6376W	ER6376W	85
6476	ER6476	85
6476W	ER6476W	86
WHIRLPOOL		
0057299	ER0057299	86
0057300*	ER0057300	86
07515700*	ER07515700	86
307458	ER307458	86
309563B	ER309563B	86
3149983	ER3149983	86
3149984	ER3149984	86
3149986	ER3149986	86
3149987	ER3149987	86
3149988	ER3149988	86
3182567	ER3182567	86
3196027	ER3196027	86
3196213	ER3196213	86
3196214	ER3196214	87
3196231	ER3196231	87
3196232	ER3196232	87
327374*	ER5308013898	82
330190	ER330190	87

OEM Part #	ERP #	PG
337360*	ERWB3K5069	82
338449*	ERWB3K5097	82
4179282	ER4179282	87
4179283	ERY07506601	91
4179304	ER4179304	87
4179305*	ER4179305	87
4315513	ER4315513	87
4315516*	ER4315516	87
4327244*	ER4327244	87
4333759*	ERWB3K5069	82
4333767*	ER4333767	87
4342557*	ERWB3K5097	82
4371476*	ER4371476	87
4371492*	ER4371492	87
4371663	ER4371663	87
4372287	ER4372287	87
4372386*	ER4372386	87
71001641	ER71001641	88
74002352	ER74002352	88
74002353	ER74002353	88
74002444	ER74002444	88
74002445	ER74002445	88
74003280	ER74003280	88
74003296	ER74003296	88
74003297	ER74003297	88
74003611	ER74003712	88
74003612	ER74003713	88
74003712*	ER74003712	88

OEM Part #	ERP #	PG
74003713*	ER74003713	88
74003909	ER74003909	88
74007733	ER74007733	88
74007794	ER74011287	89
74007918	ER74007918	88
74009773	ER74009773	88
74010132	ER74010132	88
74010839	ER74010839	88
74011260	ER74011260	89
74011287	ER74011287	89
7711P13560	ER7711P13560	89
7711P15260	ER7711P15260	89
7711P31160	ER7711P31160	89
7711P31460	ER7711P31460	89
7711P39460*	ER7711P39460	89
7731P01360	ER7731P01360	89
7731P04060*	ER7731P04060	89
7731P09460*	ER7731P09460	89
7733P01460*	ER7733P01460	89
7733P01560	ER7733P01560	89
7733P02760*	ER7733P02760	89
7733P06260*	ER7733P06260	89
7733P072-60	ER7733P072-60	89
7739P048-60	ER7739P048-60	89
8053595	ER8053595	90
8272762	ER8272762	90
8272765	ER8272765	90
8272802	ER8272802	90

OEM Part #	ERP #	PG
8273103	ER8273103	90
8273104	ER8273104	90
8273103	ER8273103	90
8273104	ER8273104	90
8273111*	ER8273111	90
8273115	ER8273115	90
8273116	ER8273116	90
8286034BL	ER8286034BL	90
9761962	ER9761962	90
98006102	ER98006102	90
98006104	ER98006104	90
98008321	ER98008321	90
Y700854	ERY700854	91
Y0055029	ERY0055029	90
Y0057293*	ERY0057293	90
Y0089057*	ERY0089057	91
Y0310525	ERY0310525	91
Y0310526	ERY0310526	91
Y0310527	ERY0310527	91
Y0311518	ER4315513	87
Y07440901*	ERY07440901	91
Y07506601	ERY07506601	91
Y07507301	ERY07507301	91
Y07517601*	ER4179305	87
Y07589200	ERY07589200	91
Y07708202	ERY07708202	91

\* Knob is NLA from OEM - still available at ERP

**To quickly search for a knob  
using a mold number,  
check out the xref tab on  
[www.erparts.com](http://www.erparts.com)**

For up-to-date cross reference, go to [www.erparts.com](http://www.erparts.com)

# OVEN RACKS

Why clean, when ERP supplies an Exact Replacement oven rack at an ERP price. Welded frame, nickel plated construction makes ERP racks durable and highly resistant to corrosion.

## Order No. ER1802G35

Replacement for Brown  
23-3/4" wide  
15-3/4" deep

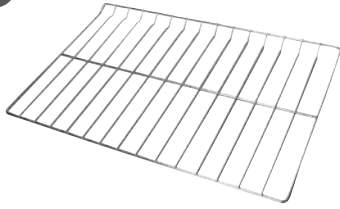

## Order No. ER1802G38

Replacement for Brown  
15-3/4" wide  
15-3/4" deep



## Order No. ER1802G39

Replacement for Brown  
18-3/4" wide  
15-3/4" deep

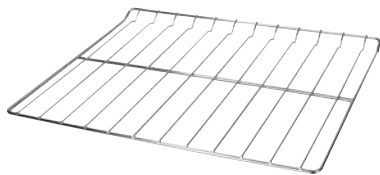

## Order No. ER3016158

Replacement for Electrolux  
15-3/4" wide  
16-11/16" deep

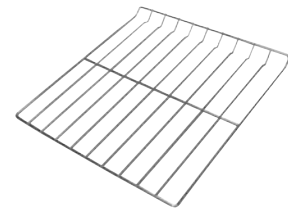

## Order No. ER316067902

Replacement for Electrolux  
22-13/16" wide  
16-1/8" deep

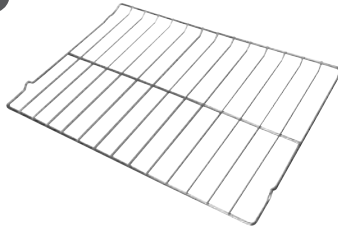

## Order No. ER5303015714

Replacement for Electrolux  
22-13/16" wide  
16-5/8" deep

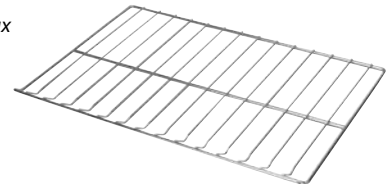

## Order No. ER5303311539

Replacement for Electrolux  
22-3/4" wide  
15-5/8" deep

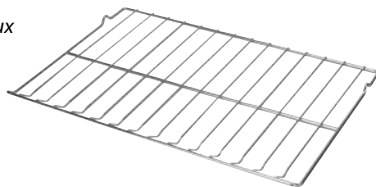

## Order No. ERWB48T10095

Replacement for GE  
23-3/4" wide  
17-1/2" deep  
Also fits:  
GE #WB48K5019

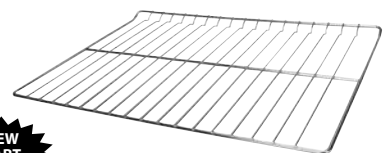

## Order No. ERWB48X137

Replacement for GE  
15-7/8" wide  
17-3/4" deep  
Also fits:  
Whirlpool #7801P01960



## Order No. ERWB48X5094

Replacement for GE  
15-3/4" wide  
15-3/4" deep  
Also fits:  
Frigidaire #5303285927  
Slattery #13001



# OVEN RACKS

## Order No. ERWB48X5099

Replacement for GE  
22-7/8" wide  
16" deep



## Order No. ER7470

Replacement for Peerless Premier  
16-1/4" wide  
16-1/4" deep

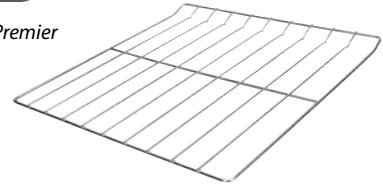

## Order No. ER7472

Replacement for Peerless Premier  
18-7/8" wide  
16-1/4" deep

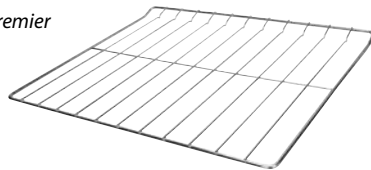

## Order No. ER13002

Replacement for Slattery  
19-3/4" wide  
16" deep

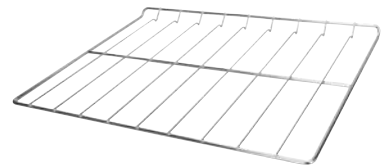

NLA  
from  
OEM

## Order No. ER4334809

Replacement for Whirlpool  
22-3/8" wide  
16-1/8" deep  
Also fits:  
GE #WB48M4

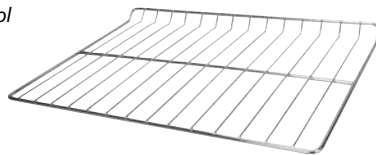

## Order No. ER4364210

Replacement for Whirlpool  
16-1/4" wide  
16-1/4" deep

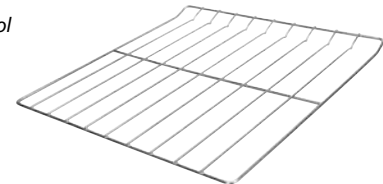

NLA  
from  
OEM

## Order No. ER4364462

Replacement for Whirlpool  
18-7/8" wide  
16-3/8" deep  
Also fits:  
Frigidaire #5303016128

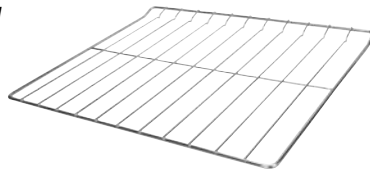

NLA  
from  
OEM

## Order No. ER4372439

Replacement for Whirlpool  
22-13/16" wide  
16-1/8" deep

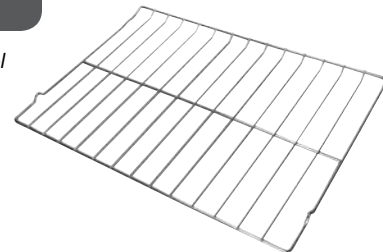

NLA  
from  
OEM

## Order No. ERW10256908

Replacement for Whirlpool  
24" wide  
16" deep

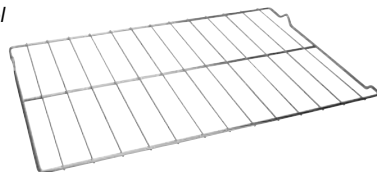

**NEW!**

## Order No. ERY0088540

Replacement for Whirlpool  
15-15/16" wide  
17-3/8" deep  
Also fits:  
GE #WB48X149  
Whirlpool #4157927



NLA  
from  
OEM

# OVEN RACKS

## Order No. ERY0088671

Replacement for Whirlpool  
23-7/8" wide  
17-1/4" deep  
Also fits:  
GE #WB48X5071  
Whirlpool #4157102

NLA  
from  
OEM

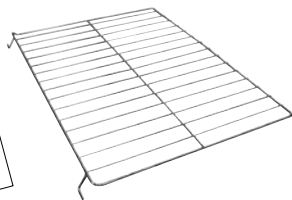

## Order No. ERY0312235

Replacement for Whirlpool  
19-7/8" wide  
17-13/16" deep

NLA  
from  
OEM

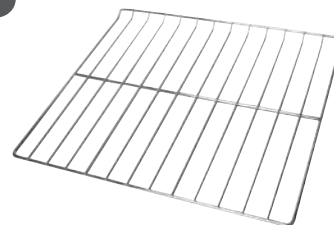

## Order No. ERY07671000

Replacement for Whirlpool  
15-15/16" wide  
17-7/8" deep

NLA  
from  
OEM

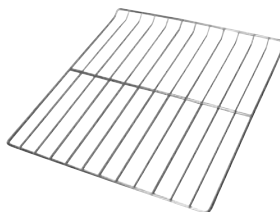

## Oven Rack Cross Reference

OEM Part #	ERP #
<b>BROWN</b>	
1802G35	ER1802G35
1802G38	ER1802G38
1802G39	ER1802G39
<b>ELECTROLUX</b>	
3016158*	ER3016158
316067902	ER316067902
5303016128	ER5303016128
5303015714	ER5303015714
5303285756	ER5303285756
5303285927	ERWB48X5094
5303311539	ER5303311539
5308013913	ER5303016128
<b>GE</b>	
WB48K5019	ERWB48T10095
WB48M4	ER4334809
WB48T10095	ERWB48T10095

OEM Part #	ERP #
WB48X137*	ERWB48X137
WB48X149*	ERY0088540
WB48X5071*	ERY0088671
WB48X5094	ERWB48X5094
WB48X5112	ERWB48X5112
WB48X5099	ERWB48X5099
WB48X5100*	ERY0088540
<b>MAGIC CHEF</b> See Whirlpool	
<b>MAYTAG</b> See Whirlpool	
<b>PEERLESS PREMIER</b>	
7470	ER7470
7472	ER7472
<b>SLATTERY</b>	
13001*	ERWB48X5094
13002*	ER13002
<b>WHIRLPOOL</b>	
4157102*	ERY0088671

OEM Part #	ERP #
4157927*	ERY0088540
4334809	ER4334809
4364085	ER4364085
4364210*	ER4364210
4364462*	ER4366462
4372439*	ER4372439
7801P01960	ERWB48X137
W10256908	ERW10256908
Y0088540*	ERY0088540
Y0088671*	ERY0088671
Y0312235*	ERY0312235
Y07671000*	ERY07671000

\* Oven Rack is NLA from OEM - Still available at ERP

For up-to-date cross reference, go to [www.erparts.com](http://www.erparts.com)

# OVEN DOOR HINGES

## Order No. ER316007002

Used on 30" models with oven window or full glass oven door



Replacement for Electrolux

## Order No. ER5303204670



Replacement for Electrolux

## Order No. ER5303204672



Replacement for Electrolux

## Order No. ER4364072

Used on 30" & 36" models with solid door, 24" models with oven door window



Replacement for Whirlpool

## Order No. ER4364472

Used on 24" models with plain solid door

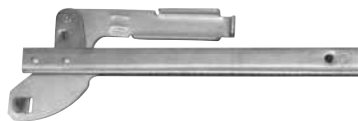

Replacement for Whirlpool

## Order No. ER98006897

NLA from OEM



Replacement for Whirlpool

- Order No. ER4455523 *Blue spring*
- Order No. ER4455524 *Red spring*
- Order No. ER4455525 *Black spring*
- Order No. ER4455526 *Yellow spring*



Replacement for Whirlpool

- Order No. ER8053807 *Red spring*
- Order No. ER8053809 *Blue spring*



Replacement for Whirlpool

## Order No. ERY07580401

10-7/8" length  
Used on 20-24" models with plain oven door

NLA from OEM



Arm color is blue

Replacement for Whirlpool

## Oven Door Hinge Cross Reference

OEM PN	ERP #
<b>ELECTROLUX</b>	
3205894	ER5303204670
3205895	ER5303204672
316007002	ER316007002
318348800	ER5303204670
318348801	ER5303204672
5303204670	ER5303204670
5303204672	ER5303204672
5304402777†	ER5304402777

OEM PN	ERP #
5304402777†	ER5304402778
5304417140	ER5304417140 †
<b>GE</b>	
WB10X5220†	ERWB10X5220
WB10X5221†	ERWB20X5221
<b>WHIRLPOOL</b>	
4315464*	ERY07580401
4364472	ER4364472
4455523	ER4455523
4455524	ER4455524

OEM PN	ERP #
4455525	ER4455525
4455526	ER4455526
8053807	ER8053807
8053809	ER8053809
98006897	ER98006897
Y0052778	ERY07580401
Y0054679*	ERY07580401
Y0086790*	ERY0086790
Y0311397*	ERY07580401
Y07580401	ERY07580401

\* Oven Door Hinge is NLA from OEM - Still available at ERP  
† ERP # not pictured in catalog - refer to pricelist



# OVEN DOOR GASKETS

Exact Replacement Oven Door Gaskets are manufactured with 100% precision extruded silicone for OEM quality and fit. Universal Oven Gaskets are available in a variety of lengths to fit a wide range of Gas and Electric oven doors. Gaskets feature pre-assembled heat treated hook/clips in gasket ends for quick and easy installation.

- Order No. ERG1012** 10" - 12"
- Order No. ERG1214** 12" - 14"
- Order No. ERG1416** 14" - 16"
- Order No. ERG1618** 16" - 18"
- Order No. ER1802156** 13-1/2"
- Order No. ERG1820** 18" - 20"
- Order No. ERG2022** 20" - 22"
- Order No. ERG2224** 22" - 24"
- Order No. ERG2427** 24" - 27"

Gasket is measured from end to end or clip to clip

"Stretch Seal" Type Oven Door Gaskets



Profile end

Flush steel spring clips attached

- Order No. ER1802144** 11"
- Order No. ER1802145** 15-1/2"
- Order No. ER1802165** 16-3/4"
- Order No. ER1802166** 18-1/2"
- Order No. ER1802167** 21"
- Order No. ER1802168** 14"

Gasket is measured from clip to clip

"Stretch Seal" Type Oven Door Gaskets



Profile end

Recessed steel spring clips attached

**Order No. ER7728**

"Stretch Seal" Type Oven Door Gasket  
24-1/2"  
2 recessed mounting clips



Profile end

Gasket is measured from clip to clip

**Order No. ER316239700**

"Formed U-Shaped" Oven Door Gasket  
50-1/2"  
12 mounting clips



Profile end

Replaces Electrolux #316239700

**Order No. ER5303051069**

"Formed U-Shaped" Oven Door Gasket  
14-1/4"  
4 mounting clips



Profile end

Replaces Electrolux #5303051069

**Order No. ER5303202011**

"Formed U-Shaped" Oven Door Gasket  
51"  
12 mounting clips



Profile end

Replaces Electrolux #5303202011

**Order No. ERWB2X7891**

"Stretch Seal" Type Oven Door Gasket  
13-3/8"  
2 mounting clips



Profile end

Replaces GE #WB2X7891

**Order No. ERWB2X7892**

"Stretch Seal" Type Oven Door Gasket  
14-5/8"  
2 mounting clips



Profile end

Replaces GE #WB2X7892

# OVEN DOOR GASKETS

## Order No. ERWB32K3

"Formed U-Shaped"  
Oven Door Gasket  
54"  
16 mounting clips

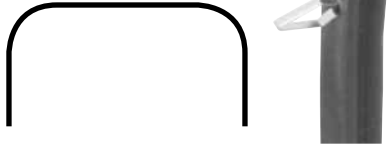

Replaces GE #WB32K3

Profile end

## Order No. ER7212P043-60

"Formed U-Shaped"  
Oven Door Gasket  
52"  
12 mounting clips

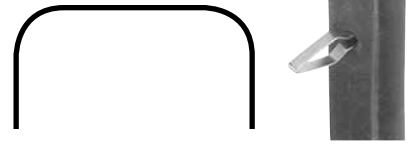

Replaces Whirlpool #7212P043-60

Profile end

## Order No. ERWB2X1522

"Tuck-in Fit" Type  
Oven Door Gasket  
64-1/4"



Replaces GE #WB2X1522

Profile end

## Order No. ERWB2X2058

"Tuck-in Fit" Type  
Oven Door Gasket  
43-1/2"  
No clips



Replaces GE #WB2X2058

Profile end

## Order No. ERG72 6' bulk

## Order No. ERWB2X5103 44-1/2"

"Tuck-in Fit" Type  
Oven Door Gaskets  
No clips



Replaces GE #WB2X5103

Profile end

## Order No. ERWB32K5051

"Tuck-in Fit" Type  
Oven Door Gasket  
50"  
No clips



Replaces GE #WB32K5051

Profile end

## Order No. ER7212P001-60 62"

## Order No. ER7212P002-60 72"

"Tuck-in Fit" Type  
Oven Door Gaskets  
No clips



Profile end

## OVEN DOOR GASKET CROSS REFERENCE

OEM Part #	ERP #
<b>ATHENS</b> See Electrolux	
<b>BROWN</b>	
1802144	ER1802144
1802145	ER1802145
1802156	ER1802156
1802165	ER1802165
1802166	ER1802166
1802167	ER1802167
1802168	ER1802168
<b>ELECTROLUX</b>	
7728*	ER7728
316239700	ER316239700
5303051069	ER5303051069
5303202011	ER5303202011
<b>GE</b>	
WB2X10139*	ERG1618
WB2X1522	ERWB2X1522
WB2X2058	ERWB2X2058

OEM Part #	ERP #
WB2X5103	ERWB2X5103
WB2X7314*	ERG1416
WB2X7315*	ERG2022
WB2X7891	ERWB2X7891
WB2X7892	ERWB2X7892
WB2X7901	ER5303202011
WB32K3	ERWB32K3
WB32K5051	ERWB32K5051
<b>MAYTAG</b> See Whirlpool	
<b>PEERLESS PREMIER</b>	
7870	ERG1618
7872	ERG2224
7874	ERG1820
7875	ERG1214
<b>SUPCO</b>	
DG1012	ERG1012
DG1214	ERG1214
DG1416	ERG1416

OEM Part #	ERP #
DG1618	ERG1618
DG1820	ERG1820
DG2022	ERG2022
DG2224	ERG2224
DG2427	ERG2427
DG5103	ERWB2X5103
DG72	ERG72
<b>WHIRLPOOL</b>	
4364083	ERG2224
4364084	ERG1618
4364208	ERG1214
4364461*	ERG1820
4371128*	ER5303202011
7212P001-60	ER7212P001-60
7212P002-60*	ER7212P002-60
7212P014-60	ERG1618
7212P016-60*	ERG2022
7212P043-60	ER7212P043-60

OEM Part #	ERP #
Y0056494*	ERG1618
Y07623602	ERG2224
Y07623603	ERG1416

\* Oven door gasket is NLA from OEM - still available at ERP

For up-to-date cross reference, go to [www.erparts.com](http://www.erparts.com)

# SMALL APPLIANCE PARTS & ACCESSORIES

## Order No. 0288

- Small Appliance Cord
- 7 foot, black, 16/2
  - Polarized ring terminals
  - Replacement for non-polarized irons and appliances

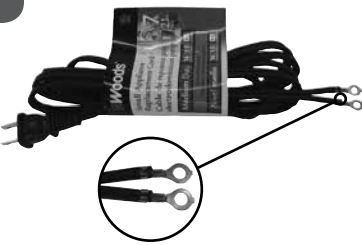

## Order No. 0290

- Small Appliance Cord
- 6 foot, black, 16/2
  - Fits all standard brand roasters, broilers and deep fryers using pin spacing 1-11/16"



## Order No. 0291

- Small Appliance Cord
- 6 foot, black, 18/2
  - Fits all kitchen appliances using 11/16" spacing between contacts such as waffle irons, grills and bottle warmers



## Order No. 0293

- Small Appliance Cord
- 2 foot, black, 18/2
  - Slotted miniature plug fits electric coffee makers, fry pans and other small kitchen appliances with 1/2" spacing between contacts

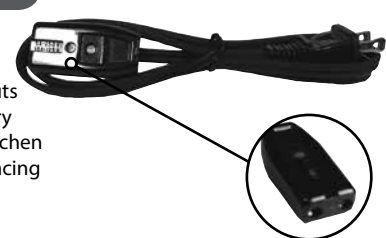

## Order No. 0294

- Small Appliance Cord
- 6 foot, black, 18/2
  - Slotted miniature plug fits electric coffee makers, fry pans and other small kitchen appliances with 1/2" spacing between contacts



## Order No. 0295

- Small Appliance Cord
- 6 foot, brown, 18/2
  - For use with pin-type construction such as mixers, electric knives, warming trays & calculators using 5/16" spacing between contacts

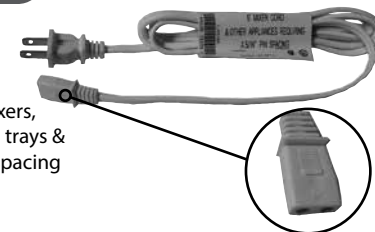

## Order No. PR100

- Thermostatic Probe Control
- Universal probe to replace units with standard size sensor and 1-3/8" pin spacing
  - Fits Sunbeam, New Presto, Dominion, Merit, Mirro, Son Chief, Lasko, Montgomery Ward, Universal West Bend, Kenmore, Sears, GE Griddles, Nelson, Thermo Wave*



## Order No. PR3F

- Thermostatic Probe Control
- Universal probe to replace units with extra wide pin spacing, 1-9/16"
  - Fits West Bend, Toastmaster, Dormeyer, Mirro (old style), Farber*



## Order No. TOP135

- Percolator Tops
- Fits percolators with size 13/16" to 1-1/2"



## Order No. TOP246

- Percolator Tops
- Fits percolators with size 1-1/2" to 2-1/2"



## Order No. ER9704230

- Blender Coupler
- Replacement for KitchenAid

**NEW!**



# SMALL APPLIANCE PARTS & ACCESSORIES

## Order No. TOP579 (pkg of 2)

- Pot Knobs
- Standard top
  - Fits most pot and pan covers, canisters, bread boxes and cookie cutters



## Order No. TOP1345 (pkg of 2)

- Appliance Knobs
- Fits all shafts to 1/4" dia.
  - Heat resistant
  - For any appliance using rotary control
  - Tightens on shaft with set screw



## Order No. TOP782 (pkg of 2)

- Pot Handles
- Two handles for one pot
  - Fits most pots from 6" to 11"
  - Heat resistant & dishwasher safe



## Order No. TOP1090

- Pan Handle
- Fits most sauce and fry pans
  - Heat resistant



## SEAL RINGS for Mirro Pressure Cookers



### Order No. S-9882

- Fits models:
- |            |            |
|------------|------------|
| #M-0312    | #M-0522-11 |
| #M-312-35  | #M-0526    |
| #M-0406    | #M-0526-11 |
| #M-0512    | #M-0528    |
| #M-0512-11 | #M-0622    |
| #M-0522    |            |

### Order No. S-9885

- Fits models:
- |            |            |
|------------|------------|
| #M-0404    | #M-0592-11 |
| #M-0534    | #M-0594-11 |
| #M-0534-03 | #M-0644    |
| #M-0534-11 | #M-0644-34 |
| #M-0534-50 | #M-1954    |
| #M-0592    |            |

### Order No. S-9891

- Fits models:
- |         |
|---------|
| #M-0396 |
| #M-0398 |

### Order No. S-9892

- Fits models:
- |            |            |            |
|------------|------------|------------|
| #M-0296    | #M-0498-35 | #M-0598    |
| #M-0296-35 | #M-0536    | #M-0598-03 |
| #M-0296-37 | #M-0536-03 | #M-0598-11 |
| #M-0296-39 | #M-0536-11 | #M-0646    |
| #M-0436    | #M-0596    | #M-0646-34 |
| #M-0436-35 | #M-0596-11 | #M-1952    |
| #M-0436-37 | #M-0596-35 | #M-1956    |
| #M-0436-39 | #M-0596-37 |            |
| #M-0498    | #M-0596-39 |            |

## Order No. 09911

- Automatic Air Vent (82060, 393, 82058)  
Fits all Presto pressure cookers and canners manufactured before 1977



## Order No. 09915

- Overpressure Plug for Presto Replacement  
For models: #PE3, #PE6, #PA4, #PA4H, #PA6, #PA6H, #PS4, #PS6, #C13, #C22, #CG22, #02111, #02151, #0210, #01221, #01240, #01250, #01260, #01261, #01310, #01340, #01350, #01360, #01780, #01770, #01750, #01740, #01710, #01751, #01781, #01241, #01264, #01282, #01341, #01362, #01363, #01364, #01370



COOKING

# SMALL APPLIANCE PARTS & ACCESSORIES

## SEAL RINGS

for Presto Pressure Cookers & Automatic Air Vent Replacement



09901



09903

### Order No. 09901

- Includes automatic air vent
- Replaces #2295, #33014
- Automatic air vent replaces #393, #82058

*Fits models: #01/PCC6, #01/PCC6A, #01/PCC6AM, #01/PCC6AD, #01/PCC6D, #01/PCC6H, #01/PCC6HD, #01/PCC6HM, #01/PCE6, #01/PCE6A, #01/PCE6H, #02/PCE6H, #106, #206, #40(6QT), #406, #603(CAN), #A601, #A603A, #A603AD, #A603AT, #A607A, #608A, #A609A, #A610A, #A611A, #A612A, #A613A, #A614A, #A615A, #A616A, #A617A, #A618A, #A619A, #A620A, #A621A, #A622A, #A623A, #KE03A, #KE03AT, #PB02A, #PB06A, #PB08A, #PB09A, #PB10A, #PB11A*

### Order No. 09902

- Includes automatic air vent & overpressure plug
- Replaces #50077, #33008, #1379

*Fits models: #01/PA6, #01/PA6H, #01/PCA6, #01/PE6, #0125\*\*, #0125001, #0125002, #0125004, #0125005, #01251\*\*, #01261\*\*, #0126101, #0126102, #0126104, #0126105, #02/PCA6, #02/PCA6H, #0215101, #0215102, #700(6QT), #706, #B601A, #B602A, #B604A, #B605A, #S-60, #S-66, #SC-35*  
\*\* Can be any number

### Order No. 09903

- Includes overpressure plug
- Replaces #50296

*Fits models: #01/PA4, #01/PA4H, #01/PE3, #01210\*\*, #0121001, #0121002, #0121004, #02111\*\*, #01221\*\*, #0122101, #0122102, #0122104, #0124001, #0124102, #0211101*  
\*\* Can be any number

### Order No. 09905

- Includes automatic air vent & overpressure plug
- Replaces #85141#1379

*Fits models: #01/C13, #01/C17, #01/C22, #01/CAA12H, #01/CAA20H, #01/CG22, #01710\*\*, #0171001, #0171002, #0171003, #01740\*\*, #0174001, #01750\*\*, #0175001, #0175002, #0175003, #0175004, #0175005, #0175006, #01770\*\*, #0177001, #01780\*\*, #0178001, #0178002, #0178003, #0178004, #0178005, #0178006, #02/CAA12H, #02/CAA16H, #02/CAA20H*  
\*\* Can be any number

### Order No. 09906

- Includes automatic air vent
- Replaces #33020

*Fits models: #01/PCS4, #01/PCS6, #02/PCS4, #02/PCS6, #803B, #804, #804B, #806, #833, #C301A, #C301B, #C401A, #C401B, #C601A, #C603A*

### Order No. 09907

- Includes automatic air vent
- Replaces #1075
- Automatic air vent replaces #393, #82058

*Fits models: #01/CA16A, #01/CA16H, #01/CA21A, #01/CA21H, #21, #21AV, #21B, #21S, #7, #7AV, #7B, #7S, #CA16, #CA16H, #CA21, #CA21H,*

### Order No. 09908

- Includes automatic air vent
- Replaces #1758
- Automatic air vent replaces #393, #82058

*Fits models: #50, #60, #603, #604*

### Order No. 09909

- Includes automatic air vent
- Replaces #1071
- Automatic air vent replaces #393, #82058

*Fits models: #01/PCC4, #01/PCC4A, #01/PCC4A, #01/PCC4A01, #01/PCC4D, #01/PCC4H, #01/PCC4HM, #01/PCD4, #01/PCD4H, #01/PCE4, #01/PCE4A, #01/PCE4H, #103, #104, #204, #40(2.5QT), #40(4QT), #403, #404, #A401, #A403A, #A403AD, #A403AT, #A409, #A409A, #A40T, #A410A, #A411A, #A412A, #A413A, #A414A, #A415A, #A416A, #KE02A, #KE02AT, #KE2AT, #PB01A, #PB05A, #PB07A*

### Order No. 09918

- Includes automatic air vent
- Replaces #50076, #33015

*Fits models: #700(3QT), #700(4QT), #733, #744, #B301A, #B301B, #B401A, #B401B*

### Order No. 09919

- Includes automatic air vent
- Replaces #50078

*Fits models: #01/PCA4, #02/PCA4, #02/PCA4H, #B302A, #B403A*

### Order No. 09924

- Includes overpressure plug

*Fits models: #0126306, #0128202, #0128303*

### Order No. 09936

- Replaces #09904, #50295

*Fits models: #01/PS4, #01/PS6, #0126002, #0126407, #0131001, #0131004, #0134001, #0134103, #0134104, #0135001, #0135004, #0136001, #0136102, #0136203, #0136304*



# COOKING MISCELLANEOUS

## Order No. ER5303051079

Oven door spring used with hinges  
#ER5303204670 and #ER5303204672



Replacement for Electrolux #5303051079

## Order No. ER12002

6-1/4" overall length  
Oven door spring (heavy)  
Used on 30" ranges with glass door or window



Replacement for Slattery #12002

## Order No. ER12005

6-1/4" overall length  
Oven door spring (medium)  
Used on 24", 30" & 36" ranges



Replacement for Slattery #12005

## Order No. ERWB2X7909

Anti Tip Kit  
51-1/2" chain  
length



Replacement for GE #WB2X7909

## Order No. ERR382

Diastat clip



Replacement for Peerless #4770;  
Whirlpool #0088050

## Order No. ER5303284616

Diastat clip



Replacement for Electrolux #5303284616

## Order No. ER5303201275

Pilot Cap



Replacement for  
Electrolux #5303211191,  
#5303201275  
GE #WB2X9086, #WB2K21  
Whirlpool #4330078, #4371075

## Order No. ER581241A01

Orifice hood fitting  
Used with 9701B series orifice  
hoods and 9724B series jets  
Used on H/W 5811, 5813 and  
5817 series safety valves



### NAT. GAS

9701B1647 #47  
9701B1648 #48  
9701B1649 #49  
9701B1650 #50  
9701B1654 #54  
9701B1655 #55  
9701B1656 #56

### LP GAS

9701B1661 #61  
9701B1669 #69

Orifice hoods



## Order No. ER581035D0178

Nat. gas pilot orifice  
.016" drill size  
Used on H/W 5412, 5414,  
5415 series pilot assemblies



## Order No. ERWB28K8

Zinc orifice

## Order No. ERWB28K7 #55

## Order No. ERWB28K10033 #59

Brass orifice



## Order No. 980068H04

Ferrule/Nut  
3/8" break-off (A)

(A)



## Order No. 986752H02

Ferrule/Nut  
3/16" break-off (B)

(B)



## Order No. ER1845G66

Indicator Light  
9" lead wires



Replacement for Brown #1845G66

## Order No. ERWB2X1608

Indicator Light  
8" lead wires



Replacement for GE #WB2X1608

## Order No. ERTA48

Heating pocket  
dial thermometer  
0°F to 220°F



# COOKING MISCELLANEOUS

## Order No. ER0088640

Indicator Light  
6" lead wires



Replacement for Whirlpool #0088640, #0088777, #4157976

## Order No. ERW10201322

Blower Motor



Replacement for Whirlpool #W10201322

## Order No. ERWB28K31

Pilot tubing  
1/4" cc mount



Replacement for GE #WB28K31

## Order No. ERWB28K10010

Tube assembly  
1/4" cc mount  
Replacement for GE #WB28K10010



## Order No. ERWB28K10009

Tube assembly  
1/4" cc mount  
Replacement for GE #WB28K10009



## Order No. ERWB28K10011

Tube assembly  
1/4" cc mount  
Replacement for GE



Replacement for GE #WB28K10011

## Order No. ERWB28K10012

Tube assembly  
1/4" cc mount  
Replacement for GE



Replacement for GE #WB28K10012

## Order No. ER316051400

Right front burner tubing  
1/4" cc mount



Replacement for Electrolux #316051400

## Order No. ERWB2X8550

Dual top pilot harness  
19-5/8" length  
1/8" NPT screw in mount



Replacement for  
Brown #1801B148  
Electrolux: #5303285728

## Order No. 5303285718

Shield, Pilot  
Also fits: Electrolux #5303285718



## Order No. ER316051401

Left front burner tubing  
1/4" cc mount



Replacement for Electrolux #316051401

## Order No. ERWB19K5

Dual top pilot harness  
20" overall length  
1/4" sleeve  
Bolt thru mount



Replacement for GE #WB19K5

## Order No. WB2K21

Cup, Pilot  
Also fits: GE #WB2K21



# COOKING MISCELLANEOUS

**Order No. ER1805F222** *left*  
**Order No. ER1805F223** *right*

Backguard endcaps  
 Used on 24", 30" & 36" models

Replacement for Brown #1805F222  
 (Left), #1805F223 (Right)



Left Right

**Order No. ER1805F224** *left*  
**Order No. ER1805F225** *right*

Backguard endcaps  
 Used on 20" models  
 High temperature resistant

Replacement for Brown #1805F224  
 (Left), #1805F225 (Right)



Left Right

**Order No. ERWB7K187** *left*  
**Order No. ERWB7K186** *right*

Oven door handle endcaps  
 Used with #WB15X5174  
 oven door handle

Replacement for GE #WB7K187  
 (Left), #WB7K186 (Right)

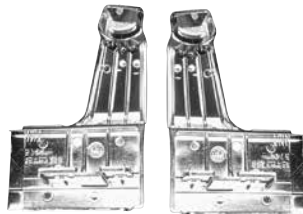

Left Right

**Order No. 58128** *almond/white*  
**Order No. 58129** *stainless steel*

Wall Splatter Shield

- 30" W x 24"H, metal
- Protects wall from grease splatter
- Durable, appliance finish, easy to clean
- Installs with 4 screws (not included)
- Made USA

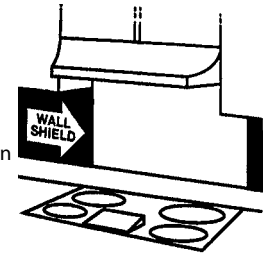

**Order No. GGC-300** 22 oz.

Gas Grate Cleaner

- Ideal for cleaning baked on food from drip bowls and broiler pans
- Safe for stainless steel and porcelain sinks
- Environmentally safe



**Order No. 50334010**

Cooktop Magic Wipes

- Recommended for all glass or ceramic smooth top surfaces
- One side scrubs, one side wipes
- Cuts through grease and removes burnt on deposits



**Order No. ERTA54**

Hanging oven thermometer  
 100°F to 600°F



**Order No. 03083**

Range Cord

- 6 foot, 3 wire, gray
- 50 amps/250 volt, 12,500 watts
- 3 closed ring end connectors
- Strain relief included
- #6/2 - 8/2 Gauge wire
- UL listed

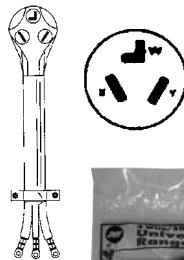

**Order No. 03096**

Range Cord

- 4 foot, 4 wire, black
- 50 amps/250 volt, 12,500 watts
- 4 closed ring end connectors
- Strain relief included
- #6/2 - 8/2 Gauge wire
- UL listed



**Order No. SE906T**

Counter Connector

- 20" L x 1-1/4" W
- Eliminates unsightly gaps between counter and range
- Prevents drips & spills between range and counter; refrigerator and counter
- Manufactured of heatproof aluminum and includes magnetic strips to hold in place



# Over The Range FILTERS

## UNIVERSAL CUT-TO-FIT RANGE HOOD FILTERS

- Order No. 1518C *Universal Charcoal Smoke & Odor Filter*
- Order No. 1518G *Universal Aluminum Grease Filter*
- Order No. 1518GC *Universal, Combination Grease & Smoke/Odor Filter (Aluminum/Charcoal)*
- Order No. 1518DIS *24-Piece Counter Display*

- Replace thousands of sizes
- Trim to exact size
- Easy to assemble
- Made in the USA
- Universal 24-piece counter display (#1518DIS) contains six 1518C, fifteen 1518G and three 1518GC

*Replace any filter up to 15" x 18" with a frame thickness as small as 11/32"*



#1518DIS

## Over The Range FILTER TYPES for Over-The-Range Microwave Ovens & Range Hoods

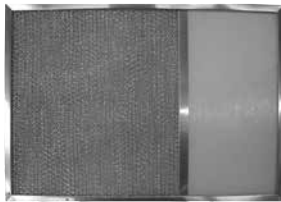

*Aluminum Grease Filter with Light Lens*



*Rectangular Aluminum Grease Filter*



*Round Aluminum Grease Filter*



*Charcoal Filter*



*Frameless Charcoal Filter*



*Combination Grease & Charcoal Filter*

# Over The Range FILTERS

## CROSS REFERENCE BY TYPE/SIZE

Length	Width	Thickness		ERP #
Aluminum Grease with Light Lens				
10-1/2"	10-1/2"	3/8"	3" lens	8512
11-1/4"	10"	1/8"	4" lens	QB1110
11-3/8"	11"	3/8"	4" lens	8515
11-13/16"	10-13/16"	3/8"	4" lens	8213
11-7/8"	10"	1/8"	4" lens	8241
12"	9"	3/8"	3" lens	QB912
12"	9"	3/8"	4" lens	8201
12"	11"	3/8"	4" lens	8577
13-7/16"	11-3/4"	3/8"	4" lens	8572
15-5/8"	10-7/8"	3/8"	5" lens	8571
16-9/16"	10-1/8"	3/8"	6" lens	8212
16-9/16"	10-1/2"	3/8"	5" lens	8570
17"	11"	3/8"	6" lens	8519
17-3/8"	17"	3/8"	6" lens	8520
Aluminum Grease				
7-3/8"	6-1/2"	3/8"		ERWB2X1559
7-9/16"	5"	1/8"	(2 pk)	ERWB06X10309
7-5/8"	5-1/8"	1/8"		FLTR012
7-5/8"	7-5/8"	3/8"		8547
7-3/4"	6"	1/8"		80QBP2031
8"	5-15/16"	1/8"		80QBP1796
8"	8"	1/8"		8140
8-3/4"	8-1/8"	1/8"		8143
8-7/8"	8-7/8"	3/8"		8505
9"	6-7/16"	1/8"		80QBP1137
9"	7-11/16"	1/8"		80QBP9083
9"	7-3/4"	1/8"		ERWB6X486
9"	9"	3/8"		8513
9-1/4"	4-15/16"	3/8"		8105
9-1/2"	7-1/4"	1/8"		8548
9-1/2"	8"	1/8"		8503
9-1/2"	8"	3/8"		ER99010033
9-1/2"	8-1/2"	1/8"		8147
9-1/2"	8-1/2"	3/8"		8176
9-1/2"	8-3/4"	3/8"		8141
9-9/16"	6-3/8"	3/32"		ERWB6X60
9-9/16"	7-1/4"	3/8"		8130
9-11/16"	5-1/4"	1/8"		80QBP1146
9-3/4"	7-1/4"	3/8"		8579
9-3/4"	9"	1/8"		8156
9-3/4"	9-3/4"	1/8"		8154
10"	7-1/4"	1/8"		80QBP1361
10"	8"	3/8"		8582
10"	9-1/2"	1/8"		8158

Length	Width	Thickness		ERP #
10"	10"	1/8"		8169
10"	10"	3/8"		8511
10-1/8"	6-3/8"	3/8"		8569
10-1/8"	9"	3/8"		8510
10-1/4"	10-1/4"	1/8"		8598
10-5/16"	10-1/8"	1/8"		8532
10-5/16"	10-1/8"	1/8"	Basket style	8167
10-3/8"	9-3/8"	3/8"		8525
10-1/2"	8-3/4"	1/8"		8504
10-1/2"	8-3/4"	3/8"		8148
10-1/2"	9"	1/8"		8150
10-1/2"	10-1/2"	1/8"	Basket style	8168
10-1/2"	10-1/2"	3/8"		8163
10-5/8"	10-5/8"	3/8"		8538
10-3/4"	5-3/4"	3/8"		ER786235
10-3/4"	6"	1/8"		ER8206229A
10-15/16"	10-1/8"	3/8"		8534
11"	8"	3/8"		8506
11"	8-1/2"	3/8"		8146
11"	8-5/8"	3/8"		8508
11"	9"	3/8"		8522
11"	10-1/4"	1/8"		8311
11"	11"	1/8"		8328
11"	11"	3/8"		8590
11-1/4"	8-1/4"	3/8"		8507
11-1/4"	8-7/16"	1/8"	Basket style	QB800
11-1/4"	8-7/16"	3/8"		8583
11-3/8"	10-3/8"	3/8"		8164
11-7/16"	10-7/16"	3/8"		8516
11-1/2"	10"	3/8"		8302
11-1/2"	10-1/4"	3/8"		8312
11-1/2"	11"	3/8"		8172
11-1/2"	11-1/2"	3/8"		8321
11-9/16"	9-13/16"	3/8"		8529
11-9/16"	10-3/4"	3/8"		8539
11-5/8"	6-5/8"	3/8"		8502
11-5/8"	11"	1/8"	Bend 5x11	8170
11-11/16"	3-7/8"	1/8"		80QBP1362
11-11/16"	9-1/16"	3/8"		8523
11-11/16"	11-11/16"	3/8"		8595
11-3/4"	8-15/16"	3/8"		8588
11-3/4"	9-1/2"	3/8"		8173
11-3/4"	10"	3/8"		8303
11-3/4"	10-3/4"	3/8"		8558
11-3/4"	11"	1/8"		8327

For up-to-date cross reference, go to [www.erparts.com](http://www.erparts.com)

# Over The Range FILTERS

## CROSS REFERENCE BY TYPE/SIZE

Length	Width	Thickness		ERP #
11-3/4"	11-1/4"	3/8"		QB10316
11-3/4"	11-1/2"	3/8"		ERR610045
11-29/32"	3-1/2"	1/8"		8108
12"	4"	1/8"		8103
12"	10"	3/8"		QB0916 2PK
12"	10-1/2"	3/8"		8313
12"	11"	3/8"		8329
12"	12"	3/8"		8180
12-1/8"	11-3/4"	3/8"		8596
12-3/8"	3-13/16"	1/8"		85QBP0107
12-7/16"	12-7/16"	3/8"		8345
12-1/2"	5"	1/8"		8542
12-1/2"	10"	3/8"		8160
12-3/4"	10"	3/8"		8304
12-7/8"	3"	3/8"		8531
13"	4-11/16"	1/8"		ERWB06X10288
13"	10"	3/8"		8307
13"	11-3/4"	3/8"		ERWB2X8422
13-1/4"	3-1/4"	1/8"		80QBP1446
13-1/4"	6-3/8"	1/2"		8564
13-1/4"	10"	3/8"		8161
13-3/8"	3-1/2"	1/8"		8540
13-3/8"	5-7/8"	1/8"		FLTR196
13-3/8"	10"	3/8"		8543
13-7/16"	8-15/16"	3/8"		8589
13-1/2"	10"	3/8"		8305
13-5/8"	10-1/2"	3/8"		8535
13-3/4"	6"	3/8"		8561
13-3/4"	10"	3/8"		8306
13-3/4"	11"	3/8"		8517
14"	10"	3/8"		8308
14"	10-1/2"	3/8"		8536
14"	11-3/8"	1/8"		8518
14"	11-1/2"	3/8"		8322
14-5/16"	11-7/8"	3/8"		QB10299 (2 pack)
14-1/2"	3-1/2"	3/8"		8541
14-3/4"	9"	3/8"		QB0915
14-15/16"	7-11/16"	3/16"	Basket style	85QBP0103
15"	4"	1/8"		8106
15"	7-5/8"	1/8"		ERR0130608
15"	8-3/4"	3/8"		8585
15"	8-13/16"	3/8"		8586
15-7/16"	13-7/16"	3/8"		8348
15-1/2"	12-3/8"	3/8"		8344
15-9/16"	6-7/8"	1/8"		8514

Length	Width	Thickness		ERP #
15-3/4"	12-1/2"	3/8"		8341
15-3/4"	16-3/4"	3/8"		ERKA240
16"	10"	3/8"		8166
16-1/8"	14-3/4"	3/8"		8185
16-3/8"	11-1/8"	3/8"		8325
16-1/2"	9"	1/8"		ERY706012
16-1/2"	11-3/4"	1/8"		8597
16-3/4"	11-3/8"	3/8"		8545
16-3/4"	15-3/4"	3/8"		8349
17"	11"	3/8"		8330
17"	12"	3/8"		8346
17-1/4"	9-1/2"	7/16"		QB0909
17-1/4"	11"	3/8"		8591
17-3/4"	9-1/2"	3/8"		8526
18-1/4"	8-3/4"	3/8"		ERWB13X5004
18-1/4"	11-3/4"	3/8"		ERWB13X5002
18-1/4"	11-3/4"	3/8"		8174
18-3/8"	11"	3/8"		8592
18-3/8"	11-1/4"	3/8"		8323
18-7/8"	9-3/4"	3/8"		8153
19"	10"	3/8"		8309
19"	18-1/2"	1/8"		8196
19-3/8"	11-1/4"	3/8"		8324
19-5/8"	12-1/2"	3/8"		8182
19-3/4"	12-1/2"	3/8"		8342
19-7/8"	3-7/8"	1/8"		80QBP1418
19-7/8"	9-1/2"	3/8"		8528
19-7/8"	12-1/2"	3/8"		8343
19-15/16"	10-5/16"	3/8"		8162
19-15/16"	11-3/4"	3/8"		8326
20"	4"	1/8"		8107
20"	10"	3/8"		8310
20"	11-7/16"	3/8"		8594
20"	13"	1/2"		QB1301
20"	18-1/2"	3/8"		8187
20"	18-1/2"	7/16"		8181
20-3/8"	10-13/16"	3/8"		8537
21-1/8"	11-1/4"	1/8"		8593
21-3/8"	13-1/2"	3/8"		8347
21-3/8"	18"	3/8"		8350
21-3/4"	5-3/4"	3/8"		8557
22-1/4"	14"	3/8"	7-7/8" wings	8194
23-1/16"	10-11/16"	3/8"		8521
23-1/2"	6-1/2"	3/8"		8724
24"	15-1/4"	3/8"		8186

For up-to-date cross reference, go to [www.erparts.com](http://www.erparts.com)



# Over The Range FILTERS

## CROSS REFERENCE BY TYPE/SIZE

Length	Width	Thickness		ERP #
24-1/4"	10-3/4"	3/8"	3" wings	8193
26-3/4"	6-1/2"	3/8"		8566
27"	4-7/8"	3/8"		8565
27"	5-1/2"	3/8"		8555
28-1/4"	6-1/4"	3/8"		8568
28-1/2"	4"	3/8"		8562
29-1/2"	8"	1/8"		8175
29-9/16"	5-3/16"	3/8"		8553
29-3/4"	4-1/2"	3/8"		ER788221
30"	9-1/2"	3/8"	8" wings	8192
Dia.	Hole	Thickness		ERP #
<b>Aluminum Grease Round</b>				
7-1/2"	3/8"	4-1/2" ctr to ctr holes		QB8730
6"	5/16"	1/8"		8530
9-1/2"	No Hole	1/8"		8599
9-1/2"	1/2"	1/8"		8501
10-1/2"	1/2"	1/8"		8580
10-1/2"	2-1/2" Dome Depth			8509
10-1/2"	3-1/2" Dome Depth			8546
11-1/2"	1/2"	1/8"		8581
Length	Width	Thickness		ERP #
<b>Charcoal</b>				
5-3/8"	5-1/8"	3/8"		ER8206230A
6"	4"	3/8"		ERWB02X11124
6-1/8"	3-7/8"	3/8"		ER5304455657
6-7/8"	2-1/4"	1/8"		6120
6-7/8"	2-5/8"	1/8"		6121
7"	4-5/8"	3/8"		6229
7-1/2"	7"	3/8"		6160
7-5/8"	4-13/16"	3/8"		ERWB02X10776
7-5/8"	2-7/8"	1/8"		6123
7-11/16"	4-13/16"	3/8"		85QBP0104
7-3/4"	7-3/4"	1/8"		6227
8-1/2"	7-1/2"	3/8"		6233
8-21/32"	4"	3/8"		ERWB02X10956
8-3/4"	6-1/8"	3/8"		ERWB02X10733
8-3/4"	8-3/4"	3/8"		6248
8-15/16"	8-15/16"	3/8"		6107
9"	8"	3/8"		6209
9-3/8"	8-7/8"	3/8"		6247
9-7/16"	5-3/4"	3/8"		80QBP1139
9-7/16"	8-13/16"	3/8"		6106
9-1/2"	8"	3/8"		6104
9-1/2"	9"	3/8"		6244
9-1/2"	9-1/2"	3/8"		6243

Length	Width	Thickness		ERP #
9-3/4"	9"	3/8"		6246
9-7/8"	7-3/4"	3/8"		6103
9-15/16"	4-13/16"	3/8"		6155
10"	4-3/4"	3/8"		80QBP3728
10"	8-5/16"	3/8"		6109
10"	9-1/2"	3/8"		6238
10"	10"	3/8"		6111
10-1/8"	9"	3/8"		6140
10-1/4"	10-1/4"	3/8"		6143
10-3/8"	10-3/8"	3/8"		6257
10-1/2"	6-1/2"	3/8"		6101
10-1/2"	8-3/4"	3/8"		6105
10-1/2"	9"	3/8"		6236
10-1/2"	10-1/2"	3/8"		6254
10-7/8"	10-7/8"	3/8"		6258
10-15/16"	10-1/8"	3/8"		6255
11"	2-1/2"	3/8"		85QBP0101
11"	2-5/8"	3/4"		80QBP1376
11"	2-11/16"	1/8"		QB-230
11"	6-1/8"	3/8"		ERWB2X9883
11"	8"	3/8"		6108
11"	8-5/8"	3/8"		6136
11"	11"	3/8"		6264
11-1/8"	7-3/32"	3/8"		6228
11-1/4"	8-5/16"	3/8"		6110
11-1/4"	8-7/16"	3/8"		6207
11-3/8"	10-1/16"	3/8"		6252
11-3/8"	10-7/16"	3/8"		6112
11-1/2"	8"	3/8"		6245
11-1/2"	10-1/4"	3/8"		6253A
11-1/2"	10-1/2"	3/8"		6131
11-1/2"	11-1/4"	3/8"		6232
11-9/16"	7-1/16"	3/8"		80QBP1144
11-9/16"	10-3/8"	3/8"		6144
11-5/8"	5-1/2"	3/8"		QB775
11-5/8"	5-7/8"	3/8"		6102
11-5/8"	7-1/16"	3/8"		QB-220
11-5/8"	9-1/8"	3/8"		6235
11-11/16"	9-3/8"	3/8"		6237
11-3/4"	7-1/2"	3/8"		6134
11-3/4"	9-1/2"	3/8"		6141
11-3/4"	10"	3/8"		6142
11-3/4"	10-7/8"	3/8"		6147
11-7/8"	11-1/2"	3/8"		6265
12"	12"	3/8"		6271

For up-to-date cross reference, go to [www.erparts.com](http://www.erparts.com)

# Over The Range FILTERS

## CROSS REFERENCE BY TYPE/SIZE

Length	Width	Thickness	ERP #
12-1/8"	12-1/8"	3/8"	6272
12-1/4"	5-3/4"	3/8"	ER6800
12-1/4"	11-3/4"	3/8"	6150
12-3/8"	11"	3/8"	6231
12-3/8"	12-3/8"	3/8"	6273
12-5/8"	7"	3/8"	80QBP0992
12-15/16"	10-13/16"	3/8"	6256
13"	11"	3/8"	6262
13-7/16"	8-15/16"	3/8"	6139
13-1/4"	3-3/4"	3/8"	6219
13-1/2"	11"	3/8"	6261
13-5/8"	5-5/8"	3/8"	6224
13-5/8"	8-5/8"	3/8"	QB-210
13-3/4"	11"	3/8"	6113
14-3/4"	11-1/2"	3/8"	6266
14-7/8"	11-5/8"	3/8"	6267
14-15/16"	9-3/16"	3/8"	6251
16-7/16"	1-7/8"	3/8"	QB-CF208
16-3/4"	11-3/8"	3/8"	6132
17"	11"	3/8"	6148
17"	11-3/8"	3/8"	6114
17-1/2"	6"	3/8"	ERWB2X4267
18-3/4"	8"	3/8"	QB-200
18-15/16"	8-15/16"	3/8"	6151
19-3/4"	7-1/4"	3/8"	6133
19-15/16"	12-9/16"	3/8"	6276
19-15/16"	12-5/8"	3/8"	6275
20"	10-3/4"	3/8"	6145
20"	11-3/8"	3/8"	6149
20"	13"	3/8"	6280
21-3/4"	5-3/4"	3/8"	6127
22-3/4"	11"	3/8"	6263
23-5/32"	4-7/8"	3/8"	6222
23-13/16"	10-11/16"	3/8"	6115
24-1/4"	11-1/32"	3/8"	6268
24-3/4"	4-1/2"	3/8"	6240
26"	6"	3/8"	6226
26-1/2"	12-3/4"	3/8"	6274
26-3/4"	4-3/4"	3/8"	6242
26-3/4"	6-3/8"	3/8"	6129
27"	4-7/8"	3/8"	6125
27"	5-3/8"	3/8"	6223
27"	5-7/8"	3/8"	6126

Length	Width	Thickness	ERP #	
28"	5"	3/8"	6250	
28-1/8"	6-1/4"	3/8"	6128	
28-9/32"	3-29/32"	1/8"	6208	
28-3/8"	4-1/8"	1/8"	6241	
28-1/2"	4"	1/8"	6124	
38-1/16"	6-3/16"	1/8"	6225	
<b>Charcoal Frameless</b>				
12-13/16"	1-5/8"	1/8"	QB-250	
12-7/8"	2-1/4"	1/8"	QB-240	
11-1/2"	1-5/8"	3/16"	FLTR090	
10-1/2"	7-3/4"	1/8"	ER883151 (3PK)	
<b>Charcoal with Light Lens</b>				
11-3/4"	11-3/8"	3/8"	3" lens	QB1111
11-3/4"	11-1/2"	3/8"	2" lens	8222
11-3/4"	11-1/2"	3/8"	3" lens	8223
11-3/4"	11-1/2"	3/8"	4" lens	8224
<b>Combination Aluminum Grease/Charcoal</b>				
7-5/8"	5"	3/8"	7512	
9"	7-3/4"	3/8"	7521	
9-1/2"	8"	3/8"	7503	
10-1/8"	9-1/2"	3/8"	7507	
10-1/2"	8-3/4"	3/8"	7506	
10-1/2"	8-15/16"	3/8"	Basket style	ERWB02X10700
10-1/2"	9"	1/8"	5107	
11"	8-5/8"	3/8"	7505	
11-1/8"	6-1/8"	3/8"	7501	
11-1/4"	8-7/16"	3/8"	7504	
11-7/16"	10-7/16"	3/8"	7508	
11-5/8"	7-1/8"	3/8"	7502	
11-5/8"	11"	3/8"	7509	
11-3/4"	11-1/4"	3/8"	QB10317	
11-3/4"	11-3/8"	3/8"	ER883149	
12-7/16"	12-3/8"	3/8"	7511	
13-3/8"	10-7/8"	3/8"	QB10308 (2 pack)	
16-3/8"	10-7/8"	1/8"	QB10309	
17"	11-7/16"	3/8"	7510	
24-1/8"	11"	3/8"	3409	
25-3/16"	4-1/8"	3/8"	7522	
<b>Combination Aluminum Grease/Charcoal with Light Lens</b>				
10-3/4"	11-3/4"	3/8"	4" lens	ERR610050
11-13/16"	11-7/16"	3/8"	3-1/4" lens	7515
12"	10"	1/8"	2-3/4" lens	7301

For up-to-date cross reference, go to [www.erparts.com](http://www.erparts.com)

# Over The Range FILTERS

## CROSS REFERENCE BY OEM PART#

OEM #	ERP#
AMF	
RBF0801	8504
RBF0901	8504
RBF1001	8167
RBF1002	8168
RCP0201	6120
RCP0202	6121
RCP0203	6123
RCP0209	6139
RCP0301	6208
RCP0302	6219
RCP0401	6124
RCP0402	6125
RCP0403	6241
RCP0404	6240
RCP0405	6242
RCP0406	6229
RCP0407	6222
RCP0408	80QBP3728
RCP0409	6155
RCP0501	6250
RCP0503	6127
RCP0504	6102
RCP0602	6223
RCP0603	6129
RCP0604	6101
RCP0606	6224
RCP0607	6225
RCP0608	6128
RCP0609	6226
RCP0610	ERWB2X9883
RCP0611	ERWB2X9883
RCP0701	6133
RCP0702	6134
RCP0703	6103
RCP0704	6160
RCP0705	6227
RCP0706	6228
RCP0707	ER883151
RCP0708	80QBP1144
RCP0709	QB-220

OEM #	ERP#
RCP0710	6233
RCP0801	6104
RCP0802	6108
RCP0803	6110
RCP0804	6109
RCP0805	6136
RCP0806	6105
RCP0807	6247
RCP0808	6107
RCP0809	6139
RCP0810	6151
RCP0811	6245
RCP0812	6207
RCP0813	6136
RCP0814	6248
RCP0815	6106
RCP0816	6106
RCP0817	6151
RCP0818	QB-210
RCP0901	6140
RCP0902	6235
RCP0903	6141
RCP0904	6244
RCP0905	6243
RCP0906	6246
RCP0907	6236
RCP0908	6237
RCP0909	6238
RCP0910	6251
RCP1001	6111
RCP1002	6142
RCP1004	6252
RCP1005	6143
RCP1008	6112
RCP1009	6115
RCP1010	6145
RCP1011	6147
RCP1012	6112
RCP1014	6257
RCP1015	6258
RCP1016	6253A

OEM #	ERP#
RCP1017	6254
RCP1018	6255
RCP1019	6256
RCP1061	6144
RCP1101	6113
RCP1102	6148
RCP1103	6132
RCP1105	6149
RCP1106	6114
RCP1107	6150
RCP1108	6264
RCP1109	6114
RCP1110	6262
RCP1111	6261
RCP1112	6263
RCP1113	6265
RCP1114	6266
RCP1115	6267
RCP1116	6268
RCP1201	6275
RCP1202	6271
RCP1203	6272
RCP1204	6274
RCP1205	6273
RCP1206	6276
RCP1301	6280
RDF1003	8509
RDF1004	8546
RHF0301	8531
RHF0303	8540
RHF0304	8541
RHF0313	80QBP1362
RHF0314	8108
RHF0403	8562
RHF0404	ER788221
RHF0408	8105
RHF0409	8565
RHF0501	8542
RHF0502	8553
RHF0503	FLTR012
RHF0505	8555

For up-to-date cross reference, go to [www.erparts.com](http://www.erparts.com)

# Over The Range FILTERS

## CROSS REFERENCE BY OEM PART#

OEM #	ERP#
RHF0506	8557
RHF0512	80QBP1146
RHF0518	ER786235
RHF0519	80QBP1796
RHF0602	8561
RHF0604	8568
RHF0606	8569
RHF0607	8566
RHF0608	8502
RHF0610	8514
RHF0619	ERWB6X60
RHF0620	ERWB2X1559
RHF0621	8502
RHF0625	80QBP2031
RHF0702	8548
RHF0705	8547
RHF0706	8579
RHF0708	8548
RHF0715	ERWB6X486
RHF0801	8503
RHF0802	ER99010033
RHF0803	8582
RHF0804	8506
RHF0805	8507
RHF0807	8583
RHF0808	8508
RHF0810	8148
RHF0811	8584
RHF0814	8505
RHF0815	8588
RHF0816	8589
RHF0821	8146
RHF0822	8196
RHF0825	8508
RHF0827	8140
RHF0836	8147
RHF0838	8146
RHF0844	8141
RHF0902	8510
RHF0903	8522
RHF0904	8523

OEM #	ERP#
RHF0905	8141
RHF0906	8525
RHF0908	8173
RHF0909	QB0909
RHF0910	8526
RHF0911	8528
RHF0912	8528
RHF0913	8153
RHF0914	8529
RHF0916	8513
RHF0920	8156
RHF0922	8150
RHF0938	8154
RHF1001	8511
RHF1002	8160
RHF1003	8161
RHF1004	8543
RHF1005	8305
RHF1006	8162
RHF1012	8516
RHF1013	8535
RHF1014	8536
RHF1015	8538
RHF1016	8521
RHF1018	8539
RHF1019	8537
RHF1020	8169
RHF1022	8302
RHF1023	QB0916
RHF1024	QB0916
RHF1025	8308
RHF1026	8598
RHF1027	8311
RHF1028	8163
RHF1030	8168
RHF1032	8303
RHF1033	8304
RHF1034	8307
RHF1035	8306
RHF1036	8166
RHF1037	8309

OEM #	ERP#
RHF1038	8310
RHF1039	8534
RHF1040	8532
RHF1041	8312
RHF1043	8313
RHF1045	8558
RHF1101	8590
RHF1102	8517
RHF1103	8330
RHF1104	8591
RHF1105	8325
RHF1107	8593
RHF1109	8518
RHF1110	8545
RHF1112	8594
RHF1113	8595
RHF1114	8596
RHF1115	8596
RHF1116	8326
RHF1117	8328
RHF1118	8172
RHF1119	8170
RHF1120	8327
RHF1124	8595
RHF1125	8329
RHF1130	8594
RHF1131	8321
RHF1133	8322
RHF1138	8323
RHF1140	8324
RHF1143	8174
RHF1201	8180
RHF1204	8346
RHF1211	8345
RHF1212	8341
RHF1213	8182
RHF1214	8343
RHF1217	ERWB13X5002
RHF1222	8344
RHF1223	8342
RHF1301	QB1301

For up-to-date cross reference, go to [www.erparts.com](http://www.erparts.com)

# Over The Range FILTERS

## CROSS REFERENCE BY OEM PART#

OEM #	ERP#
RHF1311	8348
RHF1312	8347
RHF1501	8186
RHF1503	8349
RHF1803	8350
RHP0601	7501
RHP0701	7502
RHP0801	7503
RHP0802	7504
RHP0803	7505
RHP0804	7507
RHP0807	5107
RHP0808	ERWB02X10700
RHP0901	7508
RHP1101	7509
RHP1102	7510
RHP1201	7511
RLF0901	8201
RLF1001	8214
RLF1003	8212
RLF1004	8512
RLF1007	8571
RLF1011	8570
RLF1016	8213
RLF1102	8519
RLF1103	8519
RLF1109	8577
RLF1115	8572
RLF1119	8515
RLF1701	8520
RLP1102	7315
RRF0601	8530
RRF0701	QB8730
RRF0902	8599
RRF0903	8501
RRF1002	8580
RRF1102	8581
RWF0901	8192
RWF1001	8193
RWF1401	8194
BOSCH	
368815	8192

OEM #	ERP#
830865	8170
883058	8583
BROAN	
97005683	8529
97005684	8523
97005687	6105
97006931	8504
97006981	8510
97007355	8565
97007576	6105
97007662	QB7662
97007696	6105
97007807	6140
97007808	6129
97007809	6125
97007893	8502
97007894	QB0916
97008537	6102
97008729	8536
97008730	QB8730
97009562	8503
97009563	6120
99010032	8585
99010033	ER99010033
99010036	6145
99010037	6145
99010039	8597
99010040	8555
99010042	8501
99010045	6126
99010046	8581
99010049	8596
99010087	8537
99010088	6150
99010098	8594
99010099	6149
99010101	6141
99010103	QB0909
99010108	8516
99010109	8571
99010111	6147
99010112	6127

OEM #	ERP#
99010113	6112
99010115	8557
99010118	6134
99010121	8504
99010122	8546
99010123	6105
99010135	6129
99010136	8566
99010138	8510
99010152	8528
99010159	8502
99010181	6104
99010182	6110
99010183	6109
99010184	6136
99010185	6106
99010186	6107
99010187	6112
99010188	6113
99010191	8241
99010193	8512
99010194	8572
99010195	8519
99010196	8583
99010197	8508
99010198	8505
99010199	8510
99010200	8523
99010201	8516
99010202	8517
99010212	8562
99010213	8503
99010214	8582
99010216	8535
99010221	8546
99010222	6123
99010223	6124
99010224	6143
99010239	8525
99010240	8530
99010242	8514
99010243	8518

For up-to-date cross reference, go to [www.erparts.com](http://www.erparts.com)



# Over The Range FILTERS

## CROSS REFERENCE BY OEM PART#

OEM #	ERP#
99010244	QB1301
99010245	6275
99010299	QB10299 (2 PK)
99010308	QB10308 (2 PK)
99010309	QB10309
99010315	QB10317
99010316	QB10316
99010317	QB10317
99530078	6148
<b>DACOR</b>	
82025	8153
82026	8105
82766	8103
82767	8106
82768	8107
<b>ELECTROLUX</b>	
5304408977	ERWB6X486
5304409641	ERWB2X9883
5304455657	ER5304455657
<b>GE</b>	
PM2X9883DS	ERWB2X9883
WB02X10700	ERWB02X10700
WB02X10733	ERWB02X10733
WB02X10708	QB10309
WB02X10776	ERWB02X10776
WB02X10932	8103
WB02X10943*	85QBP0101
WB02X10956	ERWB02X10956
WB02X11124	ERWB02X11124
WB2X1434	8547
WB2X1559	ERWB2X1559
WB2X1666	8542
WB2X2052	8546
WB2X2158	8591
WB2X2189	8543
WB2X2266	7510
WB2X2290	6114
WB2X2891	7508
WB2X2892	7510
WB2X2893	8516
WB2X3409	3409

OEM #	ERP#
WB2X3998	8529
WB2X4263	8548
WB2X4267	ERWB2X4267
WB2X4993	8565
WB2X6731	8541
WB2X6786	8540
WB2X7358	8520
WB2X8391	8504
WB2X8400	8546
WB2X8406	ERWB02X10700
WB2X8422	ERWB2X8422
WB2X9760	7506
WB2X9761	7510
WB2X9883	ERWB2X9883
WB06X10125	ERWB6X486
WB06X10288	ERWB06X10288
WB06X10309	ERWB06X10309
WB06X10359	FLTR012
WB06X10596	ERWB06X10596
WB06X10654	FLTR012
WB06X10823	ERWB02X11124
WB6X486	ERWB6X486
WB6X60	ERWB6X60
WB6X10288	ERWB06X10288
WB6X10359	FLTR012
WB13X5002	ERWB13X5002
<b>GEMLINE</b>	
RF204	8546
<b>KENMORE</b>	
11909	80QBP1446
13783	80QBP2031
16866	80QBP1137
84127	80QBP0992
500768	7522
503407	80QBP1144
503550	80QBP1146
46-115320-3	80QBP1139
<b>KITCHENAIRE</b>	
KA240	ERKA240
<b>MIAMI-CAREY</b>	
247VP	8501

OEM #	ERP#
320VP	8583
325VP	7504
332VP	8558
3V-3732	8532
531VP	8510
541VP	8532
<b>NUTONE</b>	
13916-000	8546
41F	6105
BP29	8504
K0790-000	8506
K0791-000	8539
K0793-000	8583
K0796-000	6108
K0798000	6110
K0799-000	6160
K3595-000	7504
K5509000	7504
K6388000	QB800
LL62F	8583
<b>PANASONIC</b>	
A400B5000AP	80QBP1418
NN-CF203	7512
NN-CF208P	QB-CF208
<b>RANGEAIRE</b>	
610004	8507
610038	8170
610039	8546
610045	ERR610045
610050	ERR610050
<b>SHARP</b>	
PFIL-0018MRE0	80QBP1361
PFIL-A003WRE0	80QBP1362
PFIL-B002MRE0	80QBP1796
PFIL-B006MRE0	QB-240
PFIL-B008MRE0	8143
PFIL-B009MRE0	FLTR090
RK200	QB-200
RK210	QB-210
RK220	QB-220
RK230	QB-230

For up-to-date cross reference, go to [www.erparts.com](http://www.erparts.com)

# Over The Range FILTERS

## CROSS REFERENCE BY OEM PART#

OEM #	ERP#
RK240	QB-240
RK250	QB-250
WHIRLPOOL	
6800	ER6800
6802	FLTR196
6802A	FLTR196
2390-0001	8540
2390-0002	3409
2390-0003	8548
2390-0004	ERWB2X4267
4158352	8579
4341970	6105
4341977	8504
4341999	6105
4342003	8529
4358003	7502
4358030	80QBP1146
4358853	FLTR012
4359331	80QBP3728

OEM #	ERP#
4378581	7506
4378584	6104
4378588	8546
4393761	ER6800
4396292	QB10309
4396389	8529
47001076	6105
53001442	80QBP1376
56001069	FLTR012
56001084	80QBP3728
707929	8518
71002111	8514
715290	8514
715526	8530
786235	ER786235
788221	ER788221
788245	6124
8169645	ER6800
8206229A	ER8206229A

OEM #	ERP#
8206230A	ER8206230A
830190	8529
830192	8505
830195	6107
830371	7509
830731	8583
830732	8345
830733	6109
830865	8170
883058	7505
883149	ER883149
883151	ER883151
R0130608	ERR0130608
R0131462	85QBP0101
R0710162	8548
R0710163	ERWB2X9883
Y0042024	8557
Y706012	ERY706012
Y05200253	ERWB2X9883

## Over The Range FILTERS MADE TO ORDER

Order using the following # system

ERP  
Part # **S** **O** **A** **14** – **1/2** X **08** – **15/16** **B**

Special Order A = Alum. Grease or Charcoal Full inches Fraction of inches Full inches Fraction of inches Thickness A = 1/8" B = 3/8"

Examples: SOA8-15/16X3-3/8B  
SOC14X9-1/2A

PRICING - See Pricelist

ERP Part # for pricing purpose

### Aluminum Grease Filter

0 - 99 sq. inches  
100 - 174 sq. inches  
175 - 250 sq. inches

ERP Part # for pricing purpose

AGFLTR0-99  
AGFLTR100-174  
AGFLTR175-250

### Charcoal Filter

0 - 99 sq. inches  
100 - 174 sq. inches  
175 - 250 sq. inches

CHFLTR0-99  
CHFLTR100-174  
CHFLTR175-250

For up-to-date cross reference, go to [www.erparts.com](http://www.erparts.com)

# REPLACEMENT BULBS

## APPLIANCE BULBS

Order No. ER15A15 15 watts  
Order No. ER25A15 25 watts  
Order No. ER40A15 40 watts  
Order No. ER60A15 60 watts  
Order No. ER60A15BT 60 watts

Appliance bulb  
120V  
Frosted, general purpose  
med. base  
(BT: blue tint)



Order No. ER40A15CLR

Appliance bulb  
40 watt, 130V  
Clear, General purpose,  
Med. base



Order No. ER4C7

Ice/Water Dispenser bulb  
4 watt, 120V  
Clear, candelabra base

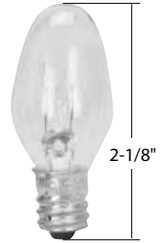

Order No. ER6S6 120V  
Order No. ERWR02X12208 12V

Straight side bulb  
6 watt  
Clear, candelabra base

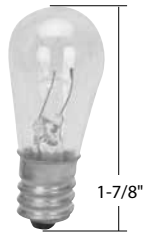

Order No. ER6S6DC

Straight side bulb  
6 watt, 130V  
Clear, bayonet double contact base



Order No. ER7C7 7 watt  
Order No. ER10C7 10 watt

Cone shape bulb  
130V  
Clear, candelabra base

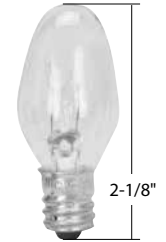

Order No. 26QB1316

Cone shape dryer bulb  
7 watt, 130V  
Blue tint, candelabra base

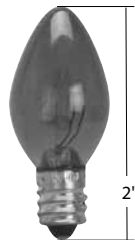

Order No. ER7C7DC

Cone shape bulb  
7 watt, 120V  
Clear, bayonet double  
contact base



Order No. ER10S6120 120V  
Order No. ER10S6230 230V

Straight side bulb  
10 watt  
Clear, candelabra base



Order No. ER10C7DC

Cone shape bulb  
10 watt, 130V  
Clear, bayonet double  
contact base



Order No. ER10S6DC

Straight side bulb  
10 watt, 120V  
Clear, bayonet double contact base



Order No. ER15T7C

Tubular shape bulb  
15 watt, 130V  
Clear, candelabra base



# REPLACEMENT BULBS

## APPLIANCE BULBS

**Order No. ER15T8** 15 watt  
**Order No. ER25T8** 25 watt

Tubular shape bulb  
120V  
Clear, candelabra base

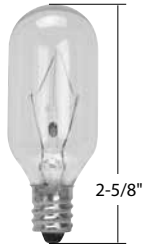

**Order No. ER15T6** 15 watt  
**Order No. ER25T6** 25 watt

Tubular shaped bulb  
120V  
Clear, candelabra base



**Order No. ER15T7N** 15 watt  
**Order No. ER25T7N** 25 watt

Tubular shape bulb  
120V  
Clear, intermediate base



**Order No. ER15T8E14**

Appliance bulb  
15 watt, 120V  
Clear, European base



**Order No. ER15T7DC** 15 watt  
**Order No. ER25T7DC** 25 watt

Tubular shape bulb  
120V  
Clear, bayonet double contact base

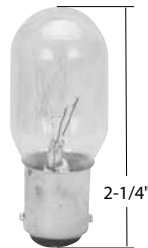

**Order No. ER20T61/2** 20 watts  
**Order No. ER25T61/2** 25 watts  
**Order No. ER40T61/2** 40 watts

Tubular shape bulb  
120V  
Clear, intermediate base

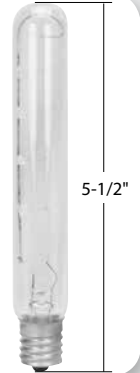

**Order No. ER25T8N**

Tubular shape bulb  
25 watt, 120V  
Clear, intermediate base

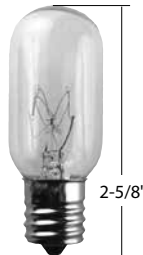

**Order No. ER25T8DC**

Tubular shape bulb  
25 watt, 120V  
Clear, bayonet double contact base



**Order No. ER25T61/2DC**

Tubular shape bulb  
25 watt, 130V  
Bayonet double contact base

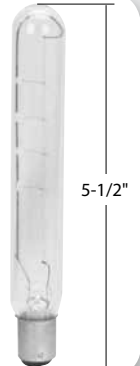

**Order No. ER40T10** clear  
**Order No. ER40T10F** frosted

Tubular shape bulb  
40 watt, 120V  
Medium base

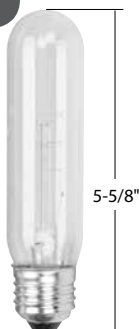

**Order No. ER40R14**

Reflector bulb  
40 watt, 130V  
Clear, medium base



**Order No. ERS4911** 120V  
**Order No. ERS4912** 130V

Reflector bulb  
50 watt  
Clear, medium base



**Order No. ERHC-H0609**

Bulb adapter  
Adapts candelabra base to a European base.

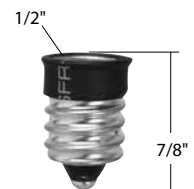

COOKING

# REPLACEMENT BULBS

## MICROWAVE BULBS

### Order No. 26QBP0930

20 watts, 120V,  $a=2-1/4"$

### Order No. 26QBP4033

20 watts, 240V,  $a=2-1/2"$

### Order No. 26QBP0932

25 watts, 130V,  $a=2-1/2"$

### Order No. 26QBP4076

30 watts, 120V,  $a=2-3/16"$   
for Sharp, Whirlpool

### Order No. 26QBP4085

30 watts, 125V,  $a=2-5/8"$

### Order No. 26QBP4093

40 watts, 130V,  $a=2-1/4"$

### Order No. 26QBP3236

40 watts, 130V,  $a=2-1/2"$

### Order No. 26QBP0936

40 watts, 130V,  $a=2-7/8"$   
Clear, intermediate base

### Order No. 26QBP4087

40 watts, 130V,  $a=3"$

Clear, intermediate base



### Order No. 26QBP0264

40 watt, 130V  
Clear, candelabra base  
*Replaces Broan #B02300264*



### Order No. 26QBP0546

25 watts, 120V  
Clear, candelabra base



### Order No. 26QBP1110

30 watt, 125V  
Clear, DC base  
for Sharp



### Order No. 26QBP0542

25 watts, 120V,  $a=2-1/4"$

### Order No. 26QBP1119

30 watts, 120V,  $a=2-5/16"$

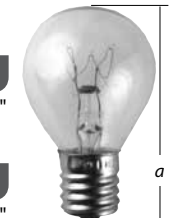

### Order No. 26QBP0544

40 watts, 120V,  $a=2-5/16"$   
*# 26QBP0544R = self-serve package*

Clear, intermediate base

### Order No. 26QBP1109

20 watts, 125V,  $a=2-5/8"$   
terminals: 1/4" apart

### Order No. 26QBP4059

25 watts, 125V,  $a=2-5/8"$   
terminals: 3/4" apart

### Order No. 26QBP4074

25 watts, 125V,  $a=2-7/8"$   
terminals: 1/4" apart

### Order No. 26QBP1108

40 watts, 130V,  $a=3-1/4"$   
terminals: 1/4" apart



### Order No. HC-H6230

25 watts, 120V,  $a=3-1/4"$

### Order No. HC-H6231

40 watts, 120V,  $a=4-5/16"$

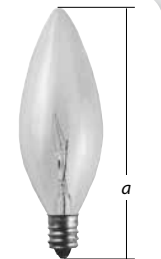

Clear, candelabra base

### Order No. 26QBP4090

20 watts, 125V,  $a=2-3/8"$

### Order No. 26QBP4082

75 watts, 250V,  $a=2-5/8"$

Bulb/base combo  
Terminals:  
3/16" male, 1/4" apart



### Order No. 26QBP1121

20 watt, 125V,  $a=2-1/2"$

### Order No. 26QBP4061

30 watts, 125V,  $a=3"$

Base/bulb combo  
Terminals: 3/16" male, 1/4" apart



### Order No. 26QBP1125

20 watts, 125V  
Bulb/base combo  
Terminals: 3/16" & 1/4" male,  
1/4" apart



### Order No. 26QBP4094

20 watt, 110V,  $a=2-3/4"$   
Terminals: 3/16" male,  
7/16" apart  
Base/bulb combo



### Order No. 26QBP0029

Lamp Socket

**NEW!**



# REPLACEMENT BULBS

## HALOGEN BULBS

### Order No. 26QBP0348

5 watts, 12V,  $a=1-13/16"$   
Width: 5/16", Pin-pin: 3/16"

### Order No. 26QBP0239

20 watts, 12V,  $a=1-3/16"$   
Width: 5/16", Pin-pin: 3/16"

### Order No. 26QBP4079

35 watts, 120V,  $a=1-11/16"$   
Width: 5/8", Pin-pin: 5/16"  
for Goldstar, Maytag

### Order No. 26QBP0177

10 watts, 12V,  $a=1-13/16"$   
Width: 5/16", Pin-pin: 3/16"

### Order No. 26QBP0213

20 watts, 120V,  $a=1-5/8"$   
Width: 5/8", Pin-pin: 5/16"

### Order No. 26QBP10007

35 watts, 130V,  $a=1-13/16"$   
Width: 1/2", Pin-pin: 1/4"

### Order No. 26QBP4092

25 watts, 120V,  $a=1-3/4"$   
Width: 1/2", Pin-pin: 1/4"

### Order No. 26QBP10021

50 watts, 130V,  $a=1-3/4"$   
Width: 1/2", Pin-pin: 5/16"

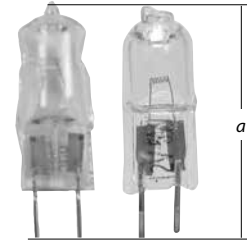

### Order No. 26QBP4395

20 watts, 12V,  $a=1-3/8"$   
Width: 1-3/8", Pin-pin: 1/8"

### Order No. 26QBP10002

20 watts, 12V,  $a=1-3/4"$   
Width: 2", Pin-pin: 1/4"

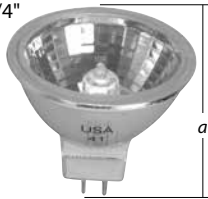

Reflector bulb

### Order No. 26QBP4091

Reflector bulb  
50 watts, 120V  
Width: 2", Pin-pin: 1/4"  
Has button style pins



### Order No. E27-50 50 watt

### Order No. E27-75 75 watt

Reflector bulb  
120V  
Clear, medium base



## FLUORESCENT BULBS

### Order No. HC-H6191

13 watts, 120V, 21" length

### Order No. HC-H6196

8 watts, 130V, 12" length

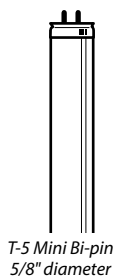

T-5 Mini Bi-pin  
5/8" diameter

### Order No. HC-10702

26 watts, 120V, 26" length

### Order No. HC-H6296

15 watts, 120V, 18" length

### Order No. HC-L6162

18 watts, 120V, 24" length

### Order No. HC-L6166

18 watts, 120V, 28" length

### Order No. QB-70826

18 watts, 120V, 26" length

### Order No. QB-70836

30 watts, 120V, 36" length



T-8 Med. Bi-pin  
1" diameter

### Order No. QB-10730

18 watts  
10,000 avg. hrs.

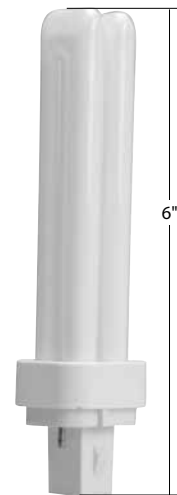

Deluxe D  
G24 base

### Order No. QB-71224

20 watts, 120V, 24" length

### Order No. QB-71228

25 watts, 120V, 28" length

### Order No. QB-71233

25 watts, 120V, 33" length

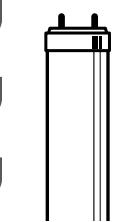

T-12 Med. Bi-pin  
1-1/2" diameter

## COMPACT FLUORESCENT



# REPLACEMENT BULBS

## Replacement Bulb Cross Reference

OEM Part #	ERP#
<b>BOSCH</b>	
070779*	ER15T8E14 (If mol.2.25" ok)
150188*	26QBP0177
157311	26QBP0177
187385	26QBP0177
189351*	26QBP0239
415426*	ER40A15
487506*	ER10S6120
<b>BROAN/NUTONE</b>	
97010730*	QB-10730
B02300264*	26QBP0264
B02300722	26QBP0239
B02300891*	26QBP0239
SV02544	ERS4911
V02544*	ERS4911
<b>DACOR</b>	
62351	E27-75
82089*	ER40A15
86573*	26QBP0177
92348*	E27-75
<b>ELECTROLUX</b>	
08027430	ER15T7DC
10506	ER7C7
13682-0	ER7C7
3001080	ER6S6
3131275*	QB-70826
63179-1*	ER7C7
215764500	ER6S6
218284900	ER6S6
240436702*	ER40A15
241552801*	26QBP0936
241689401	ER6S6
5300187180	ER6S6
5303013071*	ER40A15
5303018501	26QBP0544
5303212801*	26QBP0544
5303310286	ER40A15
5303310288*	ER4C7
5303314148*	ER40A15

OEM Part #	ERP#
5303319566*	26QBP0932
5304408949*	26QBP0936
5304421616*	ER6S6
5304440031*	26QBP0930
5305514148*	ER40A15
5308027430*	ER15T7DC
F58261	ER15T7DC
G000187180	ER6S6
G177728	ER6S6
K1307904	ER15T7DC
Q000007421	ER15T7DC
Q000007429	ER15T7DC
Q000007430	ER15T7DC
Q000016751	ER15T7DC
R000901003	ER6S6
WQ7429	ER15T7DC
WQ16751	ER15T7DC
<b>GE</b>	
10692	ER25T7N
111257	ER40A15
11367*	ER6S6
11779*	ER7C7
11975*	ER10C7
11994*	ER10C7DC
13453*	ER15T7DC
13494*	ER15T7C
14741*	ER25T7DC
14791*	ER25T8N
15199	ER40A15
15740*	ER40T61/2
25T7*	ER25T7
25T7DC*	ER25T7DC
25T7N	ER25T7N
293547	ER40A15
30T7N*	ER30T7N
630610	ER40A15
65973	ER40A15
69651	ER40A15
8004738	ER40A15
8004883	ER40A15

OEM Part #	ERP#
F26T8-CW-4*	QB-70826
WB01X10239*	26QBP0239
WB02X3551	ER40A15
WB02X4235	26QBP1119
WB02X4253	26QBP0936
WB08T10007	26QBP10007
WB08T10021*	26QBP10021
WB08T10022	ER40A15
WB08T10023*	26QBP10007
WB08X10002*	26QBP10002
WB08X10012*	26QBP4074
WB08X10014	26QBP10002
WB08X10028*	E27-50
WB08X10045	26QBP0239
WB08X10050	26QBP0213
WB08X10051	26QBP1108
WB08X10057*	26QBP1108
WB2X3551*	ER40A15
WB2X4235*	26QBP1119
WB2X4253*	26QBP0544
WB2X4611	ER25T8N
WB2X9057*	26QBP0930
WB6X15	26QBP0544
WB8K8	QB-70826
WB8X10002	26QBP10002
WB8X10014	26QBP10002
WB8X10028	E27-50
WB18X10012*	26QBP1109
WB25X10019*	26QBP0213
WB36X0003	26QBP0936
WB36X0936	26QBP0936
WB36X10002*	26QBP4059
WB36X10003*	26QBP0936
WB36X10005*	26QBP1109
WB36X10057*	26QBP1108
WB36X10061	26QBP4059
WB36X10063*	26QBP1109
WB36X10131*	26QBP1121
WB36X10132	26QBP4076
WB36X10163*	26QBP0177

OEM Part #	ERP#
WB36X10176	26QBP0239
WB36X10177	26QBP0177
WB36X10194*	26QBP4074
WB36X10213	26QBP0213
WB36X10223*	26QBP0936
WB36X10246	26QBP0213
WB36X10292*	26QBP4076
WB36X10294*	26QBP1119
WB36X10328	26QBP0936
WB36X3	26QBP0936
WB36X805*	ER25T8N
WB36X822	26QBP0936
WB36X849*	ER25T8N
WB36X863	ER25T8N
WB36X904	26QBP4074
WB36X952	26QBP4074
WB36X936	26QBP0936
WE04X10014	ER7C7
WE04X10045*	ER7C7
WE1M323	ER7C7
WE4M305*	ER10S6120
WE4X718	ER10S6120
WR02X10675	ERWR02X12208
WR02X10851*	ER15T7C
WR02X12208*	ERWR02X12208
WR2X10675	ERWR02X12208
WR2X10851	ER15T7C
WX4X10	ER40A15
WX12X20	ER40A15
WX12X79*	ER10C7DC
WX12X85*	ER25T8DC
WX12X109	ER40A15
WX12X120	ER7C7
WX12X1452	ER7C7
WX12X1456*	ER10C7DC
WX12X1510*	ER40A15
WX12X1560*	ER25T8DC
WX12X2607*	HC-L6166
WX61X2	ER7C7

\* Current OEM part numbers

For up-to-date cross reference, go to [www.erparts.com](http://www.erparts.com)

# REPLACEMENT BULBS

OEM Part #	ERP#
<b>GEMLINE</b>	
LT001*	ER6S6
LT002*	ER6S6DC
LT003*	ER7C7
LT004*	ER10C7
LT005*	ER10C7DC
LT006*	ER15T7C
LT007*	ER15T7DC
LT008*	ER25T61/2
LT009*	ER25T61/2DC
LT010*	ER25T8N
LT011*	ER25T8DC
LT012*	ER40A15
LT013*	ER40T61/2
LT014*	ER40T10
LT016*	ER60A/RS
LT018*	ER40T10F
<b>LG</b>	
6912JB2004K*	ER60A15BT (blue tint bulb)
<b>LITTON</b>	
M9D107*	HC-H6231
M9D109*	ER15T6
M9D98*	ER25T8
<b>MAYTAG/WHIRLPOOL</b>	
0053437	26QBP0544
0056142	QB-70826
0068901	ER25T8DC
0071927	QB-70826
0087273	ER25T8DC
0090395	ER25T8DC
01060018	ER25T8DC
01060024	ER25T8DC
01060028	ER25T8DC
040672-01	ER25T8N
040672-02	ER40A15
040672-04	ER25T8N
040672-05	ER25T8N
045606-01	ER25T8N
05200136*	26QBP1119
05200137	26QBP0544

\* Current OEM part numbers

OEM Part #	ERP#
05200256	ER25T8N
09100073	ER25T8N
0B00500399	QB-70826
1060024	ER25T8DC
14001558	26QBP0213
14200025	26QBP3236
14200220	26QBP0213
14200559	ER10C7
14201037	26QBP0213
14201091	ER10C7
14201152	ER60A15
14202213	QB-70826
14202454	ER25T8DC
14203519	26QBP1316
14205551	26QBP3236
14206369	ER25T8N
14206945	QB-70826
14210279	ER10C7
14210536	QB-70826
14214978	ER40A15 (orig. blue daylight bulb)
14218316	ER25T8N
14218317	26QBP3236
14218420	ER10C7
14218428	QB-70826
14218606	26QBP1316
14218659	ER25T8N
14218667	26QBP3236
1447200	QB-70826
17512*	ER10C7
18445	ER10C7
19447	ER40A15
19950037	ER40A15CLR
20174-1	26QBP3236
20174-2	ER25T8N
20174-3	26QBP3236
20174-4	26QBP3236
20174-5	ER25T8N
202479	ER25T8DC
2031415101	HC-H6231
208654	ER40T61/2

OEM Part #	ERP#
21074	ER10C7
21120	ER10C7
22002263*	ER10C7
2252970	ER40A15
2255743*	ER40A15 (orig. blue daylight bulb)
231178	ER40A15
2311792	ER40A15 (orig. blue daylight bulb)
233051	QB-70826
245289	QB-70826
245535	ER10C7
262465	ER10C7
263313	ER10C7
2635-0004	26QBP0544
28329	ER10C7
30283-A	ER25T8DC
307100	26QBP1316
31001575	ER10S6DC
311255	ER40A15
313969*	HC-H6230
3178521	ER15T8E14 (If mol 2.25" ok)
3178641	ER10C7
31956*	ER40A15
3395618*	ER25T8
3406124	ER10C7
3406125	ER10C7
35001138*	ER10C7
40407P01*	ER25T8
4158344	26QBP0544
4159007	ER10C7
4164470	26QBP0936
4173175*	ER15T8E14 (If mol 2.25" ok)
4173328	ER10C7
4173948	QB-70826
4174608	26QBP0544
4174873	26QBP0936
4179348	HC-10702
422581	QB-70826
4312826	26QBP0936

OEM Part #	ERP#
4323686	ER10C7
4324154	ER40A15
4338591	ER40A15
4343345	ER40A15
4343660	ER40A15
4343796	ER40T61/2
4343839	ER10C7
4344740	ER10C7
4350095	ER10C7
4352209	ER10C7
4358971	26QBP0936
4359625	26QBP0544
4359741	26QBP1109
4371201	QB-70826
4371303	ER40A15
4375348	26QBP0348
4393681	26QBP0544
4452164*	26QBP0348
4452166	ER15T8E14 (If mol 2.25" ok)
44865P01*	ER15T6
4713-001013	26QBP3236
4713-001165*	26QBP0213
4713-001172	ER25T8N
4713-001199	ER10C7
49001047	26QBP4091
49001187*	ER40R14
503006	ER40T61/2
504714	ER40T61/2
504757	ER40T61/2
520224	ER25T8DC
526921	ER40T61/2
527949	ER40A15
528513	ER10C7
53001359	ER25T8N
53001420	26QBP4079
53001773	ER25T8N
53001905*	26QBP4079
53-0177	ER25T8DC
53-0570	ER25T8DC
54001046	26QBP3236

For up-to-date cross reference, go to [www.erparts.com](http://www.erparts.com)

# REPLACEMENT BULBS

OEM Part #	ERP#
547225	ER40T61/2
548049*	ER40T61/2
550017	QB-70826
550871	QB-70826
55771	ER60A15
55771-1	ER60A15
55771-2	ER60A15
56001070*	Socket NLA can use 26QBP1113 for 20W, 26QBP4059 for 25W, 26QBP4061 for 30W & 26QBP1108 for 40W bulb @ 125V
56001071	26QBP0544
56001089*	26QBP0544
58001043	26QBP3236
58001101*	ER25T8N
58001310	ER25T8N
60954	26QBP1316
61001787*	ER60A15
61003236*	26QBP3236
61004862	26QBP3236
63179-1	26QBP1316
63179-1A	ER7C7
6521	ER25T8N
661555*	ER25T8DC
67001316*	26QBP1316
67001316A	ER7C7
68001062	ER25T8N
68123-1	ER40A15
701247	ER25T8DC
707319	ER40A15
71003600	QB-70826
74004458*	26QBP0177
74009925	26QBP4092
7407P004-60	QB-70826
7407P037-60*	QB-70826
7407P103-60*	ER40A15CLR
786594	QB-70826
790170	ER25T8DC

OEM Part #	ERP#
8009*	ER40A15
816389	ER40A15
8170385	ER60A15
8183592	26QBP4061
8183993*	26QBP4076
8186287*	26QBP0348
8190269*	26QBP0936
8204670*	26QBP0177
8204855	26QBP0544
8205586	26QBP0544
8206232*	26QBP4093
8206443*	26QBP0544
831294	ER40T61/2
878799	QB-70826
90051	26QBP3236
92045-1	26QBP3236
95292*	QB-70826
A0278301	ER25T8DC
A0282803	ER40A15
A0282806	ER40A15
A0282807	ER60A15
A0352501	ER25T8DC
A3073101*	ER25T8N
A3079001	26QBP3236
A3079001Q	26QBP3236
A3079002	26QBP3236
A3079003	26QBP3236
A3079007	26QBP3236
A307901	26QBP3236
A3167501*	ER25T8DC
DE07-00006A	26QBP4074
M0360001	26QBP1316
M0360001Q	26QBP1316
M0360302	QB-70826
M9D1	ER40A15
R0130823*	ER25A15
R0131024	26QBP4061
R0165010	QB-70826
R0213161	ER25T8N
R0605087	26QBP1316

OEM Part #	ERP#
R0662001	ER25T8N
R0713504	Socket NLA can use 26QBP1113 for 20W, 26QBP4059 for 25W, 26QBP4061 for 30W & 26QBP1108 for 40W bulb @ 125V
R0713676*	26QBP3236
R0812001	ER25T8N
R0812005	ER25T8N
R9900292	ER25T8N
R9900310	26QBP0544
W10114395*	26QBP4395
Y0053437*	26QBP0544
Y0056142	QB-70826
Y0067945*	HC-L6166
Y0068901	ER25T8DC
Y0071927	QB-70826
Y0087273	ER25T8DC
Y0090395	ER25T8DC
Y01060008	ER25T8DC
Y01060018	ER25T8DC
Y01060024	ER25T8DC
Y01060028	ER25T8DC
Y0315927	QB-70826
Y04067201	ER25T8N
Y04067204	ER25T8N
Y09100073	ER25T8N
Y0B00500399	QB-70826
Y307100	26QBP1316
Y520224	ER25T8DC
Y60954	26QBP1316
Y701247	ER25T8DC
Y90395	ER25T8DC
<b>QB</b>	
HC-D0504*	ER25A15
HC-H6161*	ER20T61/2
HC-H6163*	ER25T61/2DC
HC-H6205*	ER25T8DC
HC-H6234*	ER6S6

OEM Part #	ERP#
HC-H6235*	ER6S6DC
HC-H6237*	ER25T8
HC-H6247*	ER25T6
HC-H6248*	ER25T61/2DC
HC-H6264*	ER15T7C
HC-H6266*	ER25T8N
HC-H6268*	ER7C7
HC-H6270*	ER15T7N
HC-H6271*	ER15T7DC
HC-H6272*	ER15T6
HC-H6273*	ER25T61/2
HC-H6276*	ER15T8
HC-H6281*	ER15T7N
HC-H6284*	ER40T10
HC-H6285*	ER40T10F
HC-H6289*	ER40A15
HC-H6291*	ER10C7
HC-H6700*	ER40T61/2
HC-W9062*	ER7C7DC
HC-W9063*	ER10C7DC
<b>SHARP</b>	
RLMPTA086WRZZ	26QBP0930
<b>SUB ZERO</b>	
3030030*	ER40A15
3030040*	ER40T61/2
3030060*	ER25T8N
<b>SUPCO</b>	
10C7*	ER10C7
10C7DC*	ER10C7DC
15T7C*	ER15T7C
15T7DC*	ER15T7DC
25T61/2*	ER25T61/2
25T61/2DC*	ER25T61/2DC
25T8DC*	ER25T8DC
25T8N*	ER25T8N
40A15*	ER40A15
40T10*	ER40T10
40T10IF*	ER40T10F
6S6*	ER6S6
6S6DC*	ER6S6DC
7C7*	ER7C7

\* Current OEM part numbers

For up-to-date cross reference, go to [www.erparts.com](http://www.erparts.com)

# MICROWAVE OVEN OPERATION

## How a Microwave Operates

The microwave oven produces RF energy in the form of Radio Waves that cycle 2450 million cycles per second. These MICRO-WAVES have 3 main characteristics. They can penetrate certain materials as if it wasn't even there, materials like glass, mica, paper and some plastics. Secondly, there are materials like metal that the microwaves cannot penetrate and basically just bounce off of. And thirdly, there are materials like FOOD that micro-waves do penetrate and basically are absorbed in the material.

The food absorbs the microwaves and the microwaves cause the molecules in the food to move rapidly creating friction between them which creates the heat that cooks the food. The microwaves only penetrate the outer portion of the food but the heat is conducted inwards to cook the food completely.

It is the MAGNETRON in the microwave oven that produces the microwaves. The magnetron needs approx. 4000 Volts to go into oscillation to generate the microwaves. The microwave oven has basically 2 sections, the low voltage section which actually controls the unit and the high voltage section whose components include the magnetron and the components that power up the magnetron. The high voltage transformer or the new style inverter is the component that separates the 2 sides.

The low voltage (control section) takes the 120 volts, passes it through all the safety devices like the interlock switches, thermal fuses and powers up the control device. On the older models the control device was the timer which told the triac to close and send power to the high voltage transformer; on the new units it is the PCB control board that performs that function. The fans, turntable motors and lights are also powered from the low voltage section.

The high voltage section consists of the high voltage transformer, the doubling circuit and the magnetron. The transformer takes the 120 volts from the low voltage section and increases it to approx. 2000 volts and feeds it to the doubling circuit. The doubling circuit consists of the HV Capacitor and the HV diode. The HV diode converts the voltage to DC and the capacitor discharges the 2000 volts and sends it to the magnetron. This adds to the 2000 volts that comes direct from the HV transformer and gives the magnetron the 4000 Volts needed to go into oscillation. On some of the new models this is all done by the inverter board.

The microwaves leave the magnetron through its antenna and goes into the waveguide where they bounce around the metal waveguide and into the oven cavity until they are absorbed by the food. Some models have stirrer blades to direct the microwaves randomly in the cavity to reduce uneven heating. Some models use a rotating tray to reduce uneven heating. The glass tray is used so microwaves can enter the bottom of the food for complete penetration.

Typical Microwave Oven Schematic

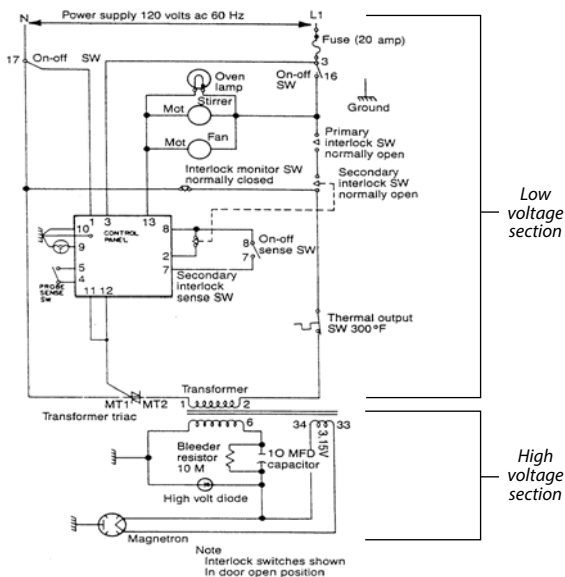

Microwave Cooking

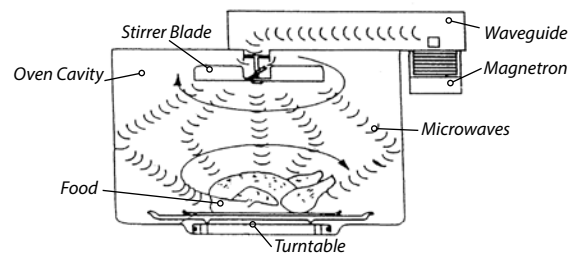

1. Microwaves produced by magnetron enters the metal waveguide.
2. Microwaves travel down the waveguide and are stirred up by the stirrer blade as they enter the oven cavity.
3. As they enter the metal oven cavity they bounce around until they are absorbed into food.
4. Microwaves absorbed in food set the molecules in such a frenzied motion that they heat through friction.

Does the food in a microwave oven cook from the inside out?

Contrary to popular belief, microwaved food does not cook from the inside out. Instead, the microwaves penetrate the first 1" to 1-1/2" of the food, and heat is then drawn to the center by conduction. The theory of food cooking from the inside out comes from the fact that because the air in the microwave is cool, heat dissipates off the surface of the food quickly.

# MICROWAVE OVEN OPERATION

## Microwave Control Panel Parts

1. Control Panel
2. Door Choke
3. Door Frame
4. Door Latch Key
5. Door Open Button
6. Inner Door Sheet
7. LCD Display & PCB Control Board
8. Outer Door Glass
9. Outer Door Panel
10. PCB, Power Supply
11. Select Button
12. Touch Pad
13. LCD Holder

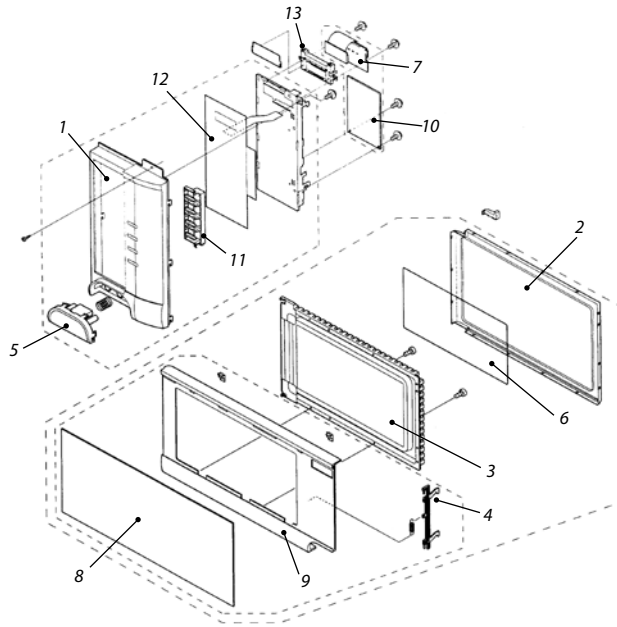

Please note that not all parts shown are used in all models of microwaves.

## Microwave Oven & Cabinet Parts

1. Body Latch Board
2. Charcoal Filter
3. Cooling Fan Motor
4. Door Open Lever
5. Door Switches
6. Exhaust Blower Motor Assembly
7. Fuse
8. Fuse Holder
9. Glass Tray
10. Grease Filters
11. High Voltage Capacitor
12. High Voltage Diode/Rectifier
13. High Voltage Transformer
14. Magnetron
15. Magnetron High Limit Thermostat
16. Mounting Plate
17. Oven Lamp
18. Rangehood Lamp
19. Thermostats
20. Turntable Motor
21. Turntable Support
22. Vent Louver
23. Waveguide Cover

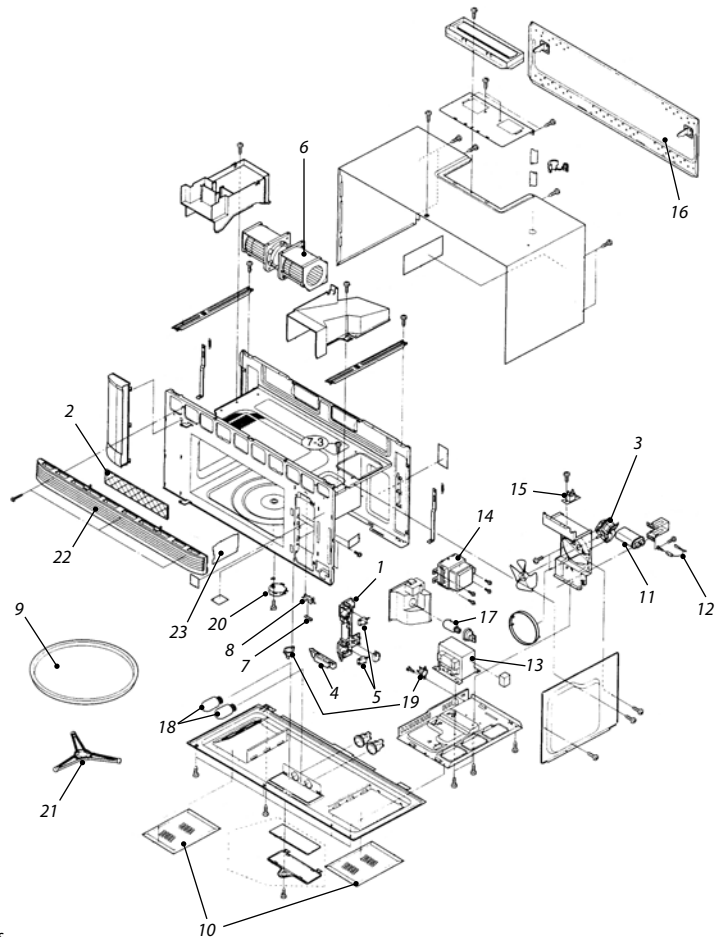

Please note that not all parts shown are used in all models of microwaves.



# HIGH VOLTAGE CAPACITORS

All ERP capacitors are built with an internal bleeder resistor and will replace non-bleeder types. The bleeder resistor is a safety device built into the capacitor to discharge the capacitor when the unit is turned off. Capacitors rated at 2100V will replace capacitors rated up to 2500V when used in any home microwave (non-commercial) rated at 1,000 watts or less.



Available with 1/4" or 3/16" male terminals

## UNIVERSAL 2100V FOR DOMESTIC APPLICATIONS

**Universal High Voltage Capacitors with 1/4" male terminals** Each capacitor is equipped with four 1/4" male quick disconnect terminals. Case temperature rating 70°C. Rated at 2100V.

**Popular Direct Replacement High Voltage Capacitors with 3/16" male terminals** (depicted with a -1) Rated @2100V with 3/16" male quick disconnect terminals. Commonly used in Panasonic and Quasar microwaves. For values not shown, use our 1/4" terminal capacitors and our 13QBPADAPTR Adapter Kit.

**High Voltage Capacitor Kits** (depicted with a K at the end of the part #) Replacement for Sanyo HV capacitors with internal diode (or without internal diode) and special mounting brackets. One kit replaces both base and side mount brackets. Reduces inventory. Available in four most common values.

## 2500V FOR COMMERCIAL APPLICATIONS

For commercial applications using 2500V capacitors.

Choose your capacitor nearest to your original value. Standard Mfg. tolerance is 6% ±3% (i.e. If you have .88 MFD capacitor use 13QBP21090 - .90MFD)

### FYI: Capacitors' nomenclature for ease of ordering

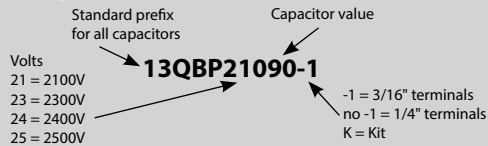

### Terminal Reducer Adapter Kit

Reduces 1/4" terminals to 3/16". Allows you to substitute universal 1/4" HV capacitors in Panasonic & other applications using 3/16" terminals. Eliminates the need to convert wire terminals.

**ERP #13QBPADAPT**  
(Kit of 2 adapters)

ERP #	Volt	Value	Height	Width	Depth	Terminal	Kit #
<b>Domestic</b>							
13QBP20075	2000	.75	2.50"	2.00"	1.25"	1/4" male	
13QBP21055	2100	.55	2.50"	2.00"	1.25"	1/4" male	
13QBP21065	2100	.65	2.50"	2.00"	1.25"	1/4" male	13QBP21065K
13QBP21080	2100	.80	2.50"	2.00"	1.25"	1/4" male	
13QBP21085	2100	.85	3.00"	2.00"	1.25"	1/4" male	13QBP21085K
13QBP21090	2100	.90	3.00"	2.00"	1.25"	1/4" male	
13QBP21090-1	2100	.90	3.00"	2.00"	1.25"	3/16" male	
13QBP21095	2100	.95	3.00"	2.00"	1.25"	1/4" male	
13QBP21095-1	2100	.95	3.50"	2.00"	1.25"	3/16" male	
13QBP21097	2100	.97	3.00"	2.00"	1.25"	1/4" male	13QBP21097K
13QBP21100	2100	1.00	3.00"	2.00"	1.25"	1/4" male	13QBP21100K
13QBP21105	2100	1.05	3.00"	2.00"	1.25"	1/4" male	
13QBP21110	2100	1.10	3.00"	2.00"	1.25"	1/4" male	
<b>Commercial</b>							
13QBP25075	2500	.75	3.75"	2.00"	1.25"	1/4" male	
13QBP25085	2500	.85	4.00"	2.00"	1.25"	1/4" male	
13QBP25090	2500	.90	4.75"	2.00"	1.25"	1/4" male	
13QBP25097	2500	.97	4.75"	2.00"	1.25"	1/4" male	
<b>Popular Exact Replacements</b>							
13QBP23100	2300	1.00	4.12"	2.00"	1.25"	1/4" male	
13QBP24094	2400	.94	1.50"	2.00"	1.25"	1/4" male	



# DIODES

## Order No. 11QBUNIV

Universal Diode Kit  
Length: 3-5/8"  
kV: 12 mA: 350

Stock this one diode and replace the majority of diodes commonly used. Diode uses two 1/4" female quick disconnect terminals. Just select correct terminal adapter and attach to correct side of diode.



**NOTE:** Due to the high resistance of a HV diode, it cannot be tested with just any V.O.M. The V.O.M. must be set on the highest resistance setting, and the V.O.M. must be an analog meter using a 9V battery or have an R x 10m scale. Digital meters reduce the 9V to operate the meter and cannot be used.

## Order No. 11QB0234

Length: 3-3/8" kV: 12 mA: 350  
Terminals:  
Banded side= #8 ring  
Non-banded= 3/16" female quick disconnect



Fits: GE, Panasonic, Quasar & many other brands

## Order No. 11QB0235

Length: 3-1/2" kV: 12 mA: 350  
Terminals:  
Banded side= #8 ring  
Non-banded= 1/4" male quick disconnect



Fits: Amana, Whirlpool & many other brands

Banded side Non-banded side



The silver band indicates the direction of current flow. Current flows from the non-banded side to the banded side.

## Order No. 11QB0236

Length: 3-1/2" kV: 12 mA: 350  
Terminals:  
Banded side= #8 ring  
Non-banded= 1/4" female quick disconnect



Fits: GE, Electrolux, Emerson & many other brands

## Order No. 11QB0237

Length: 3-5/16" kV: 12 mA: 350  
Terminals:  
Banded side= #8 ring  
Non-banded= 1/4" female quick disconnect wrapped in heat shrink tubing



Fits: GE, Goldstar, Maytag & many other brands

## Order No. 11QB0526

Length: 10-5/8" kV: 12 mA: 350  
Terminals:  
Banded side= #8 ring  
Non-banded= 2-1/4" female quick disconnect



Fits: Kenmore, Sanyo & many other brands

## Order No. 11QB0527

Length: 3-5/16" kV: 12 mA: 350  
Terminals:  
Banded side= 1/4" female quick disconnect  
Non-banded= 1/4" female flag quick disconnect



Fits: Whirlpool & many other brands

## Order No. 11QB0528

Length: 3-5/8" kV: 12 mA: 350  
Terminals:  
Banded side= 3/16" female quick disconnect  
Non-banded= 1/4" female quick disconnect



Fits: Electrolux, Whirlpool & many other brands

## Order No. 11QB0529

Length: 6" kV: 12 mA: 350  
Terminals:  
Banded side= #8 ring  
Non-banded= 3/4" female quick disconnect



Fits: Jenn-Air, Maytag & many other brands

## Order No. 11QB0530

Length: 12" kV: 12 mA: 350  
Terminals:  
Banded side = #8 ring  
Non-banded = 2-1/4" female quick disconnect on "Y" lead



Fits: GE, Goldstar, Electrolux, Kenmore, Sharp & many other brands

## Order No. 11QB0531

Length: 3" kV: 15 mA: 750  
Terminals:  
Banded side = 1/4" male quick disconnect  
Non-banded = 1/4" male quick disconnect



Fits: GE & many other brands

# DOOR HANDLES

## Order No. 25QBP0513

Almond  
10-1/8" L x 1-1/4" W  
8-1/2" on center holes  
*Replacement for Goldstar, LG, Kenmore*



## Order No. 25QBP0514

Black  
9-7/8" L x 1-1/8" W  
8-1/2" on center holes  
*Replacement for Goldstar, LG, Kenmore*



## Order No. 25QBP0521

Pewter  
9-7/8" L x 1-1/8" W  
9" on center holes  
*Replacement for Goldstar, LG, Kenmore*



## Order No. 25QBP1550

Black  
8-1/8" L x 1" W  
6-1/2" on center holes  
*Replacement for Sanyo*



## Order No. 25QBP3765

White  
9-7/8" L x 1-1/8" W  
8-3/32" & 8-15/16" on center holes  
*Replacement for Sharp*



## Order No. 25QBP3770

White  
10-1/8" L x 1-1/8" W  
8-1/2" on center holes  
*Replacement for Goldstar, LG, Kenmore*



## Order No. 25QBP3777

Black  
11-3/4" L x 1" W  
10-15/16" on center holes  
*Replaces GE #WB15X337*



## Order No. 25QBP3778

White  
11-3/4" L x 1" W  
10-15/16" on center holes  
*Replaces GE #WB15X338*



## Order No. 25QBP3779

Black  
11-5/8" L x 1-1/8" W  
10-9/32" on center holes  
*Replaces GE #WB15X10020*



## Order No. 25QBP3780

White  
11-5/8" L x 1-1/8" W  
10-9/32" on center holes  
*Replaces GE #WB15X335*



## Order No. 25QBP3784

Black  
11-3/16" L x 1-1/8" W  
8-3/4" & 9-7/8" on center holes  
*Replaces GE #WB15X10022*



## Order No. 25QBP3785

White  
11-3/16" L x 1-1/8" W  
8-3/4" & 9-7/8" on center holes  
*Replaces GE #WB15X10023*



# DOOR LATCH KEYS

## Order No. 80QBP0787

Plastic - double key  
7-15/16" L x 2-3/16" W  
Thickness: 5/16"  
Replacement for Sharp



## Order No. 80QBP2524

Plastic - double key  
7-5/8" L x 2" W  
Thickness: 1/4"  
Replacement for Sharp



## Order No. 80QBP2621

Plastic - double key  
6-3/4" L x 2-1/16" W  
Thickness: 5/8"  
Replacement for Sharp



## Order No. 80QBP2671

Plastic - double key  
8-7/8" L x 1-7/8" W  
Thickness: 9/16"  
Replacement for Sharp



## Order No. 80QBP2699

Plastic - single key (Left)  
1-1/16" L x 2-1/8" W  
Thickness: 5/8"  
Replacement for Sharp



## Order No. 80QBP2804

Plastic - single key (Right)  
1-1/16" L x 2-1/8" W  
Thickness: 5/8"  
Replacement for Sharp



## Order No. 80QBP7638

Plastic - double key  
7-5/8" L x 2" W  
Thickness: 3/16"  
Replacement for Sharp



## Order No. 80QBP8588

Plastic - double key  
6-3/8" L x 2" W  
Thickness: 3/8"  
Replacement for Goldstar



## Order No. 80QBP8680

Plastic - double key  
4-7/8" L x 2" W  
Thickness: 1/8"  
Replacement for Panasonic



## Order No. 80QBP8834

Plastic - double key  
5-1/8" L x 1-3/4" W  
Thickness: 3/16"  
Replacement for Panasonic



# DOOR OPEN BUTTONS

## Order No. 80QBP0827

Black  
3-1/4" length  
1-5/8" width  
1" depth  
*Replacement for Panasonic*



## Order No. 80QBP1175

Black  
2-7/8" length  
15/16" width  
1-1/2" depth  
*Replacement for Sharp*



## Order No. 80QBP4019

Almond  
2-3/8" length  
1" width  
1-5/8" depth  
*Replacement for Sharp*

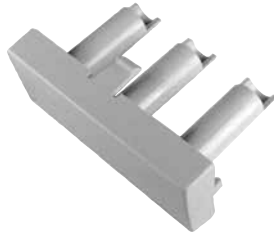

## Order No. 80QBP7370

Black  
3-1/8" length  
1-3/8" width  
1-5/8" depth  
*Replacement for Sharp*



## Order No. 80QBP7371

White  
4-1/8" length  
1-3/8" width  
1-5/8" depth  
*Replacement for Sharp*



## Order No. 80QBP7373

Black  
3-7/16" length  
2" width  
1-5/8" depth  
*Replacement for Sharp*



## Order No. 80QBP8658

Black  
1-11/16" length  
1-5/8" width  
1-5/8" depth  
*Replacement for Sharp*



## Order No. 80QBP8668

White  
3-7/8" length  
1-7/8" width  
1-3/4" depth  
*Replacement for Sharp*



## Order No. 80QBP8677

Black  
4" length  
1-5/8" width  
1-3/4" depth  
*Replacement for Sharp*



## Order No. 80QBP8715

Stainless Steel  
4-3/16" length  
1-11/16" width  
1-11/16" depth  
*Replacement for Sharp*



# FUSES

**Fast Blow** fuses are quick acting protectors for use in general circuit applications where high surges or transients are not anticipated.

**Slow Blow** fuses are generally used in circuits subject to high inrush currents or other transient surges. Microwave ovens fall in this category, although some manufacturers equip their units with fast blow fuses. As microwave ovens age, some degradation of components occur increasing current requirements. When older units, originally equipped with fast blow fuses experience nuisance interruptions, it is acceptable to replace with a slow blow fuse of the same amp rating.

**CFB:** ceramic fast blow      **BAF, BAN, FLM, NLM, SC:** midget fuse type  
**CSB:** ceramic slow blow

## FUSESTATS

1" diameter thread

ERP #	Amp	Volt	Type
14QBP0247	15	125	Slow blow
14QBP0248	20	125	Slow blow
14QBP0251	30	125	Slow blow



## FUSETRONS

3/4" diameter thread

ERP #	Amp	Volt	Type
14QBP0249	15	125	Slow blow
14QBP0250	20	125	Slow blow
14QBP0252	30	125	Slow blow



## Order No. 14QBP.25GSB20MM

Replaces Whirlpool W10111684

Glass Fuse  
 .25 amp 250V slow blow  
 5 MM dia. x 20 MM long

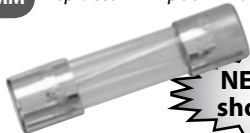

**NEW style short fuse!**

## Order No. 14QBP04CSB20MM

Replaces Whirlpool W10121103

4 amp ceramic slow blow  
 5 MM dia. x 20 MM long



**NEW style short fuse!**

Used on Emerson

## Order No. RF-3AMPFB 3 amp

## Order No. RF-5AMPFB 5 amp

250 V glass fast blow  
 5 MM dia. x 32 MM long



## CERAMIC FUSES

1-1/4" L x 1/4" diameter

Fast blow replaces:

6AB, SP, RABC, 3AB, 314, ABC, CES-2, CES-4

Slow blow replaces:

3ABSB, 326, CES-6, MDA, MWO, 373, 3WO



ERP #	Amp	Volt	Type
14QBP10CFB	10	250	Fast blow
14QBP12CFB	12	250	Fast blow
14QBP15CFB	15	250	Fast blow
14QBP18CFB	18	250	Fast blow
14QBP20CFB	20	250	Fast blow
14QBP25CFB	25	125	Fast blow
14QBP30CFB	30	125	Fast blow
14QBP08CSB	8	250	Slow blow
14QBP10CSB	10	250	Slow blow
14QBP12CSB	12	250	Slow blow
14QBP15CSB	15	250	Slow blow
14QBP18CSB	18	250	Slow blow
14QBP20CSB	20	250	Slow blow
14QBP25CSB	25	125	Slow blow
14QBP30CSB	30	125	Slow blow

**NEW!**

## MIDGET FUSES



ERP #	Amp	Volt	Length	Dia.	Type
14QBP15BAF	15	250	1-1/2"	13/32"	BAF/BLF
14QBP20BAF	20	250	1-1/2"	13/32"	BAF/BLF
14QBP30BAF	30	250	1-1/2"	13/32"	BAF/BLF
14QBP15BAN	15	250	1-1/2"	13/32"	BAN/BLN
14QBP20BAN	20	250	1-1/2"	13/32"	BAN/BLN
14QBP25BAN	25	250	1-1/2"	13/32"	BAN/BLN
14QBP30BAN	30	250	1-1/2"	13/32"	BAN/BLN
14QBP20FLM	20	250	1-1/2"	13/32"	FLM/FNM
14QBP30FLM	30	250	1-1/2"	13/32"	FLM/FNM
14QBP20NLM	20	250	2"	9/16"	NLM/NON
14QBP25NLM	25	250	2"	9/16"	NLM/NON
14QBP30NLM	30	250	2"	9/16"	NLM/NON
14QBP10SC	10	250	1-5/16"	13/32"	SC/SLC
14QBP15SC	15	250	1-5/16"	13/32"	SC/SLC
14QBP20SC	20	250	1-5/16"	13/32"	SC/SLC

# MAGNETRONS



## WARNING! Electrical Shock Hazard

Even partial disassembly of a microwave oven can expose a dangerous electric shock and radiation hazard. Service of microwave ovens should be performed only by qualified service personnel.

**CAUTION:** While ERP components are engineered for a broad range of applications, it is the responsibility of the service technician to determine the suitability of a particular application by observing proper electrical and mechanical constraints. ERP shall not be held liable for any injury or damage arising from the misuse or misapplication of its products.



There are approximately five manufacturers of microwave oven magnetrons in the world, and most of these manufacturers are located in the Far East. Anyone manufacturing a microwave oven must purchase the magnetron from one of these manufacturers.

What this means is that many microwave manufacturers use the same or similar magnetrons and that many are interchangeable.

## Magnetron Identification is as easy as 1 - 2 - 3!

### 1) ELECTRICAL CHARACTERISTICS Match up kV Rating

The electrical characteristics of a magnetron cannot be determined without elaborate testing equipment or the manufacturer's spec sheets. Therefore, you must rely on the research done by us. Look for your industry # below to obtain your kV rating.

Industry #	kV	Industry #	kV	Industry #	kV	Industry #	kV	Industry #	kV	Industry #	kV
0M52	4.1	2M130	UC*	2M163	4.1	2M209	3.8	2M229	4.1	2M258	4.1
0M55	4.1	2M131	UC*	2M164	UC*	2M210	4.1	2M230	3.8	2M259	UC*
0M72	4.1	2M137	UC*	2M167	4.1	2M211	3.8	2M231	3.8	2M261	4.35
0M75	4.1	2M140	4.1	2M170	4.1	2M213	3.8	2M233	4.1	2M262	UC*
2M101	4.1	2M141	UC*	2M172	4.1	2M214	4.1	2M234	3.8	2M266	UC*
2M103	4.1	2M142	UC*	2M181	UC*	2M216	3.8	2M236	4.1	2M268	4.35
2M105	4.1	2M150	UC*	2M186	UC*	2M217	4.1	2M238	4.1	2M269	4.35
2M106	4.1	2M151	UC*	2M188	4.1	2M218	4.1	2M240	4.1	2M282	4.35
2M107	4.1	2M152	4.1	2M189	4.1	2M219	4.1	2M244	4.35	2M45	UC*
2M108	4.1	2M153	UC*	2M189	3.8	2M220	3.8	2M245	4.1	2M500	4.1
2M115	UC*	2M156	UC*	2M200	4.1	2M221	3.8	2M246	4.35	2M53	4.1
2M115	UC*	2M157	4.1	2M203	UC*	2M222	4.1	2M247	4.35	2M53*	UC*
2M120	UC*	2M158	4.1	2M204	4.1	2M223	3.8	2M248	4.35	2M53A*	UC*
2M121	UC*	2M160	4.1	2M205	UC*	2M224	4.1	2M250	UC*	2M57	4.1
2M125	UC*	2M161	4.1	2M207	3.8	2M226	4.1	2M253	4.1	2M700	4.1
2M128	4.1	2M162	UC*	2M208	4.1	2M228	4.1	2M254	4.1	2M71	4.1

\*UC signifies an uncommon kV rating. Magnetrons with uncommon kV ratings cannot be replaced with standard magnetrons. See our model cross reference (on the website) for exact replacement magnetrons.

*PLEASE NOTE:* Use of the wrong kV rated magnetron will result in one or more of the following:

- 1) Magnetron will not go into oscillation,
- 2) Magnetron will not function properly or will overheat
- 3) Magnetron's life will be reduced substantially.



# MAGNETRONS

## 2) PHYSICAL CHARACTERISTICS Match up size, configuration, antenna height & bracket

### SIZE

Present-day magnetrons come in three different sizes. In most cases, you cannot replace a smaller one with a larger one due to allotted space.

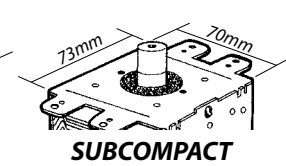
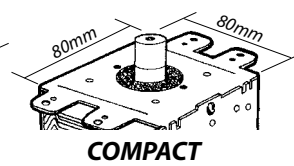
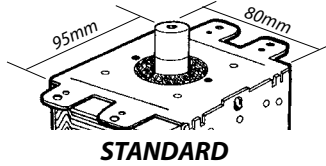

### CONFIGURATION

Configuration is the relationship between the mounting ears, the vents (airflow) and the filament leads. Manufacturers have designated letter codes for various configurations. The following are the four most popular configurations:

#### E CONFIGURATION

Mounting ears opposite vents and filament leads

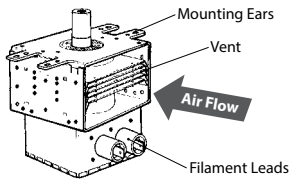

#### H CONFIGURATION

Vents and mounting ears in line with filament leads

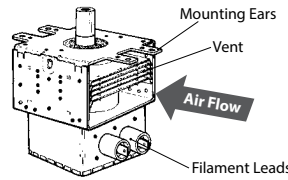

#### J CONFIGURATION

Vent and mounting ears opposite filament leads

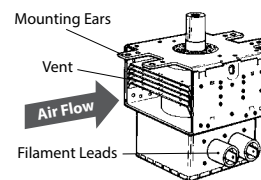

#### K CONFIGURATION

Mounting ears and filament leads opposite vents

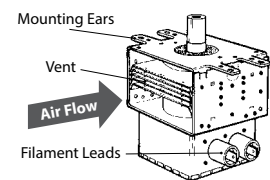

### ANTENNA HEIGHT

Many manufacturers are enlarging the cavity size without increasing the overall size of the microwave. They do this by reducing the size of the waveguide and shortening the antenna height.

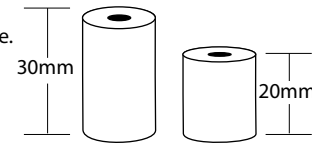

### BRACKET

The most popular bracket is what we refer to as the standard bracket. It has two sets of mounting ears coming off of the opposite sides of the top plate of the magnetron with mounting holes spacing as shown. Some manufacturers are using other style mounting brackets which cannot be replaced with our universal type brackets. See pages 24 through 30 for correct replacement.

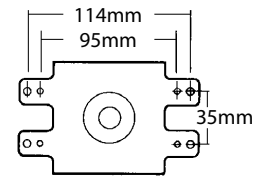



## 3) IDENTIFY PART NUMBER

Match the correct magnetron using the chart below of the most popular magnetrons with standard bracket.

kV	Watts	Size	Config.	Antenna	Part No.	Page
4.35	900-1000	Standard	E	30mm	10QBP1007	117
4.35	900-1000	Standard	H	30mm	10QBP1003	117
4.35	900-1000	Standard	J	30mm	10QBP1005	117
4.35	900-1000	Standard	K	30mm	10QBP1004	118
4.1	700-850	Standard	E	30mm	10QBP0235	118
4.1	700-850	Standard	H	30mm	10QBP0231	118
4.1	700-850	Standard	J	30mm	10QBP0230	118
4.1	700-850	Standard	K	30mm	10QBP0232	119
4.1	700-850	Compact	E	30mm	10QBP0239	119
4.1	700-850	Compact	H	30mm	10QBP0226	119
4.1	700-850	Compact	J	30mm	10QBP0234	119
4.1	700-850	Compact	K	30mm	10QBP0228	120
3.8	500-650	Subcompact	H	30mm	10QBP0311	120
3.8	500-650	Subcompact	J	30mm	10QBP0315	120

For magnetrons with special brackets and 20 mm antennas, see magnetron section on pages 24 - 30.

### IMPORTANT NOTES

- The shape of the antenna cover or the size of the hole in the cover does not affect the operation of the magnetron. 
- There are two standard ways manufacturers connect the filament leads. 
  - Fig. 1 Both leads housed in one insulating block
  - Fig. 2 Each lead housed in its own insulating block

In 99% of the applications, the filament leads consist of single wires with a 1/4" quick disconnect female terminal. Therefore, both styles are interchangeable. One percent of the time a plastic block is used, which houses both individual wires. If your replacement magnetron doesn't accept this block, remove the block and connect individual wires to the proper terminal, making certain terminals do not arc against the cabinet cover.

### CAUTION

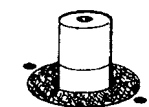
When reinstalling a removed magnetron, for whatever reason, make certain woven metal RF gasket is properly seated at base of antenna. 

# MAGNETRONS

**FINDING YOUR MAGNETRON** All magnetrons are sorted in the following order for ease of locating:

- 1) kV rating: 4.35, 4.1, 3.8
- 2) Size: Standard, Compact, Subcompact
- 3) Configuration: E, GA, G, H, J, K
- 4) Antenna: 30, 20

**Order No. 10QBP1001**



Peak Anode Voltage: 4.35 kV  
 Type: Standard  
 Configuration: H  
 Antenna: 30mm  
 Power Rating: 900-1000 watts

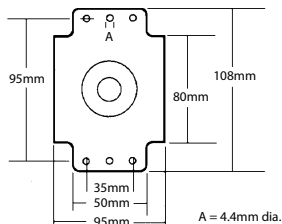

**Order No. 10QBP1012**



Peak Anode Voltage: 4.35 kV  
 Type: Standard  
 Configuration: H  
 Antenna: 30mm  
 Power Rating: 900-1000 watts

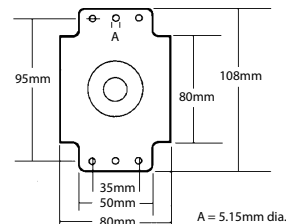

**Order No. 10QBP1003**

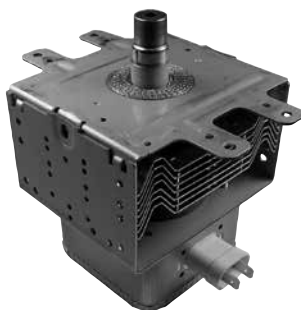

Peak Anode Voltage: 4.35 kV  
 Type: Standard  
 Configuration: H  
 Antenna: 30mm  
 Power Rating: 900-1000 watts

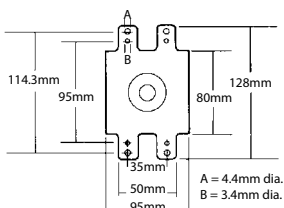

**Order No. 10QBP1003K**

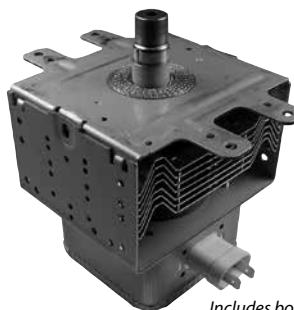

Peak Anode Voltage: 4.35 kV  
 Type: Standard  
 Configuration: H  
 Antenna: 30mm  
 Power Rating: 900-1000 watts

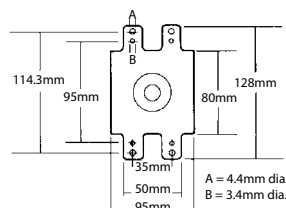

Includes bolt kit #98QB0928

**Order No. 10QBP1005**



Peak Anode Voltage: 4.35 kV  
 Type: Standard  
 Configuration: J  
 Antenna: 30mm  
 Power Rating: 900-1000 watts

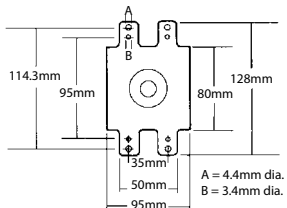

**Order No. 10QBP1000**

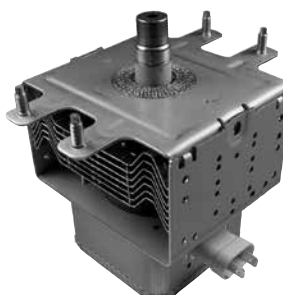

Peak Anode Voltage: 4.35 kV  
 Type: Standard  
 Configuration: J  
 Antenna: 30mm  
 Power Rating: 900-1000 watts

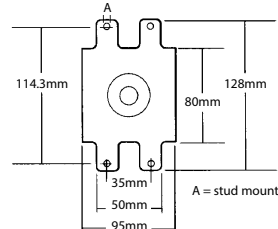

**Order No. 10QBP1009**



Peak Anode Voltage: 4.35 kV  
 Type: Standard  
 Configuration: J  
 Antenna: 30mm  
 Power Rating: 1000 watts

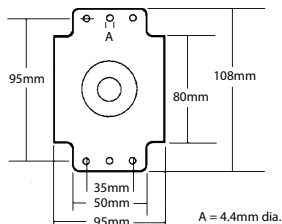

**Order No. 10QBP1006**

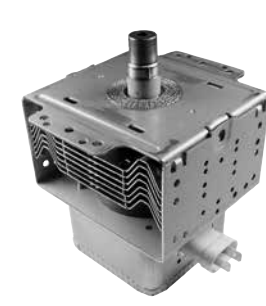

Peak Anode Voltage: 4.35 kV  
 Type: Standard  
 Configuration: J  
 Antenna: 30mm  
 Power Rating: 1000 watts

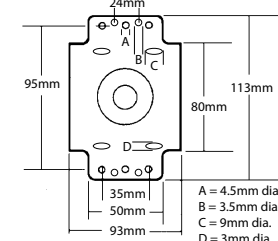

MICROWAVE

# MAGNETRONS

**FINDING YOUR MAGNETRON** All magnetrons are sorted in the following order for ease of locating:

- 1) kV rating: 4.35, 4.1, 3.8
- 2) Size: Standard, Compact, Subcompact
- 3) Configuration: E, GA, G, H, J, K
- 4) Antenna: 30, 20

## Order No. 10QBP1004



Peak Anode Voltage: 4.35 kV  
 Type: Standard  
 Configuration: K  
 Antenna: 30mm  
 Power Rating: 900-1000 watts

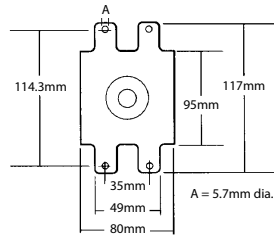

## Order No. 10QBP0235

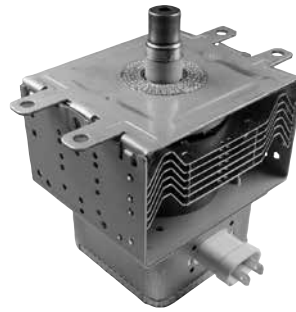

Peak Anode Voltage: 4.1 kV  
 Type: Standard  
 Configuration: E  
 Antenna: 30mm  
 Power Rating: 700-850 watts

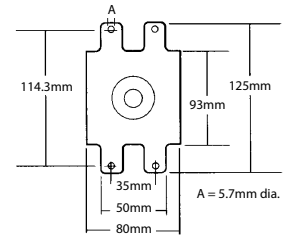

## Order No. 10QBP0246



Peak Anode Voltage: 4.1 kV  
 Type: Standard  
 Configuration: G  
 Antenna: 30mm  
 Power Rating: 700-800 watts

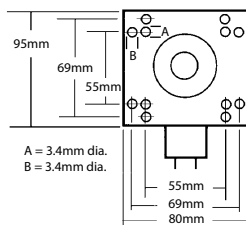

## Order No. 10QBP0231

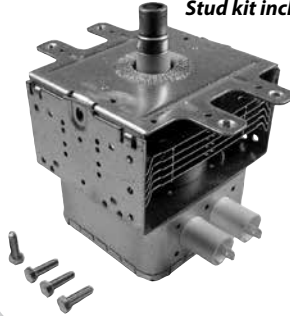

**Stud kit included**

Peak Anode Voltage: 4.1 kV  
 Type: Standard  
 Configuration: H  
 Antenna: 30mm  
 Power Rating: 700-850 watts

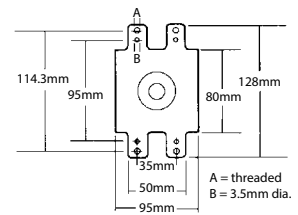

## Order No. 10QBP0229

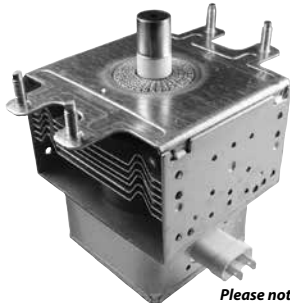

Peak Anode Voltage: 4.1 kV  
 Type: Standard  
 Configuration: J  
 Antenna: 30mm  
 Power Rating: 700-850 watts

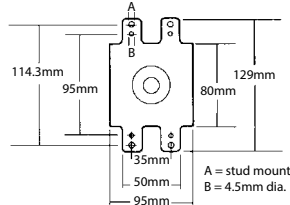

**Please note:** May have thread-in studs instead of permanent studs. May have individual filament insulators in place of dual.

## Order No. 10QBP0230

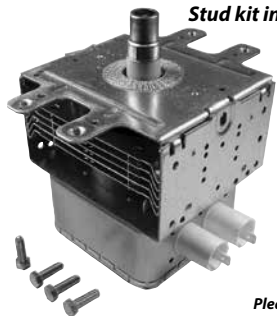

**Stud kit included**

Peak Anode Voltage: 4.1 kV  
 Type: Standard  
 Configuration: J  
 Antenna: 30mm  
 Power Rating: 700-850 watts

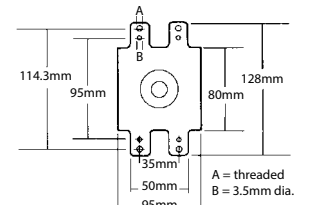

**Please note:** Replaces 10QBP0229 when stud kit is used.

## Order No. 10QBP0275



Peak Anode Voltage: 4.1 kV  
 Type: Standard  
 Configuration: J  
 Antenna: 30mm  
 Power Rating: 700-800 watts

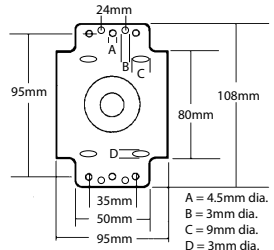

## Order No. 10QBP0259

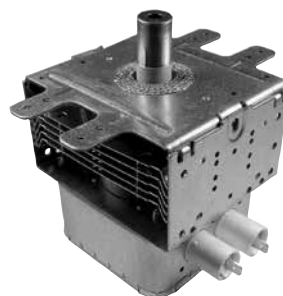

Peak Anode Voltage: 4.1 kV  
 Type: Standard  
 Configuration: J  
 Antenna: 30mm  
 Power Rating: 700-800 watts

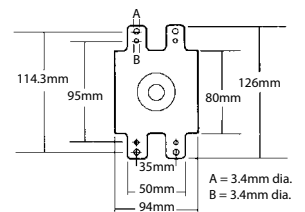

# MAGNETRONS

**FINDING YOUR MAGNETRON** All magnetrons are sorted in the following order for ease of locating:

- 1) kV rating: 4.35, 4.1, 3.8
- 2) Size: Standard, Compact, Subcompact
- 3) Configuration: E, GA, G, H, J, K
- 4) Antenna: 30, 20

**Order No. 10QBP0232**

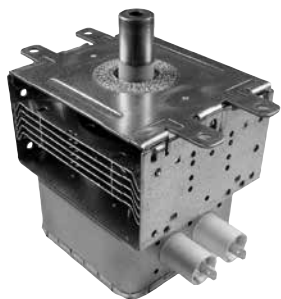

Peak Anode Voltage: 4.1 kV  
 Type: Standard  
 Configuration: K  
 Antenna: 30mm  
 Power Rating: 700-850 watts

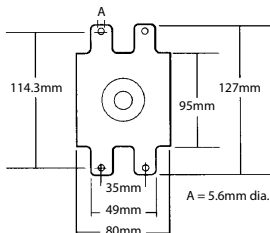

**Order No. 10QBP0239**

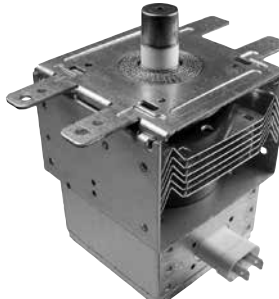

Peak Anode Voltage: 4.1 kV  
 Type: Compact  
 Configuration: E  
 Antenna: 30mm  
 Power Rating: 700-850 watts

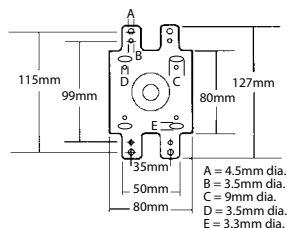

**Order No. 10QBP0226**

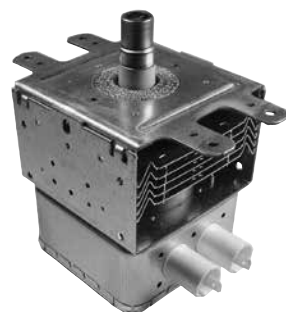

Peak Anode Voltage: 4.1 kV  
 Type: Compact  
 Configuration: H  
 Antenna: 30mm  
 Power Rating: 700-850 watts

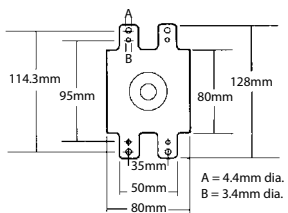

**Order No. 10QBP0249**



Peak Anode Voltage: 4.1 kV  
 Type: Compact  
 Configuration: H  
 Antenna: 30mm  
 Power Rating: 700-800 watts

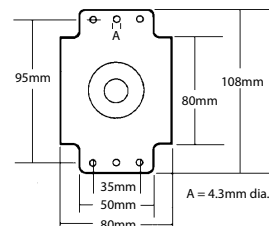

**Order No. 10QBP0238**

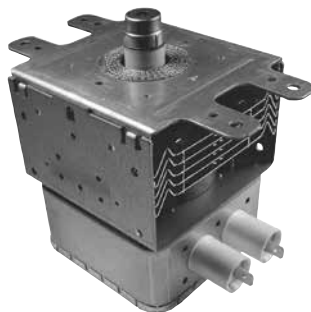

Peak Anode Voltage: 4.1 kV  
 Type: Compact  
 Configuration: H  
 Antenna: 20mm low profile  
 Power Rating: 700-850 watts

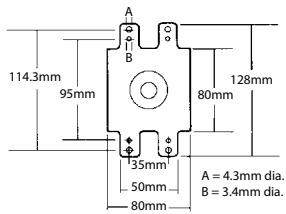

**Order No. 10QBP0234**

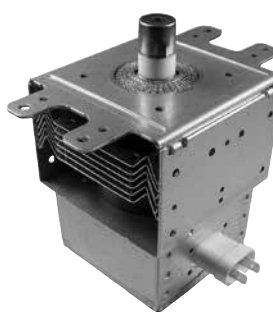

Peak Anode Voltage: 4.1 kV  
 Type: Compact  
 Configuration: J  
 Antenna: 30mm  
 Power Rating: 700-800 watts

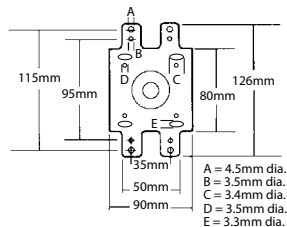

**Order No. 10QBP0227**

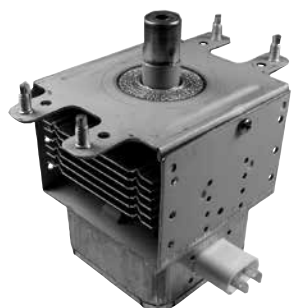

Peak Anode Voltage: 4.1 kV  
 Type: Compact  
 Configuration: J  
 Antenna: 30mm  
 Power Rating: 700-800 watts

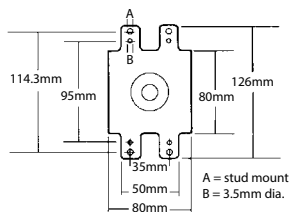

**Order No. 10QBP0243**



Peak Anode Voltage: 4.1 kV  
 Type: Compact  
 Configuration: J  
 Antenna: 30mm  
 Power Rating: 700-800 watts

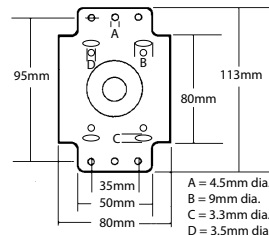



# MAGNETRONS

**FINDING YOUR MAGNETRON** All magnetrons are sorted in the following order for ease of locating:

- 1) kV rating: 4.35, 4.1, 3.8
- 2) Size: Standard, Compact, Subcompact
- 3) Configuration: E, GA, G, H, J, K
- 4) Antenna: 30, 20

## Order No. 10QBP0228

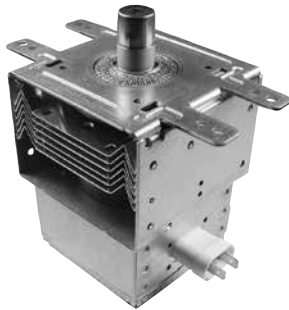

Peak Anode Voltage: 4.1 kV  
 Type: Compact  
 Configuration: K  
 Antenna: 30mm  
 Power Rating: 700-800 watts

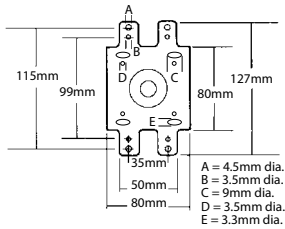

## Order No. 10QBP0300



Peak Anode Voltage: 4.1 kV  
 Type: Subcompact  
 Configuration: H  
 Antenna: 20mm low profile  
 Power Rating: 500-600 watts

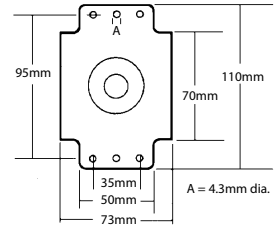

## Order No. 10QBP0311



Peak Anode Voltage: 3.8 kV  
 Type: Subcompact  
 Configuration: H  
 Antenna: 30mm  
 Power Rating: 500-650 watts

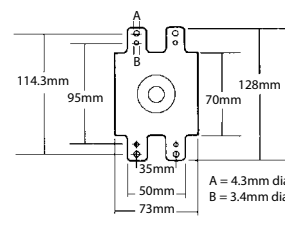

## Order No. 10QBP0309



Peak Anode Voltage: 3.8 kV  
 Type: Subcompact  
 Configuration: H  
 Antenna: 30mm  
 Power Rating: 500 watts

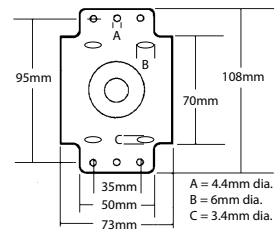

## Order No. 10QBP0315



Peak Anode Voltage: 3.8 kV  
 Type: Subcompact  
 Configuration: J  
 Antenna: 30mm  
 Power Rating: 500-600 watts

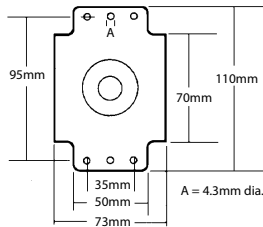

## Order No. 98QB0928

**Magnetron Mounting Bolts**  
 Pkg. of 4  
 Size 5mm



## Order No. 98QB0929

**Magnetron Mounting Nuts**  
 Pkg. of 4  
 Size 5mm



## Magnetron Lookup by MODEL Number

Enter a model number in the search box on our X-REF page. When your model comes up, click on it. The magnetron and all other parts we presently have for that model will come up showing the ERP part number. Many will show a picture next to the listing.

If your model does not seem to be showing up in our cross reference, try entering just the beginning letter and/or number, then all models starting with those letters and/or numbers from our cross reference will appear.

## Magnetron Lookup by PART Number

Enter the OEM's part number, manufacturer's part number or ERP part number into the search box on our X-REF page. Our cross reference will start to search for available matches to your entry. It will return the ERP number that should be used to place an order.

Here's an example of a manufacturer's part number



Magnetron manufacturing number



# SWITCHES

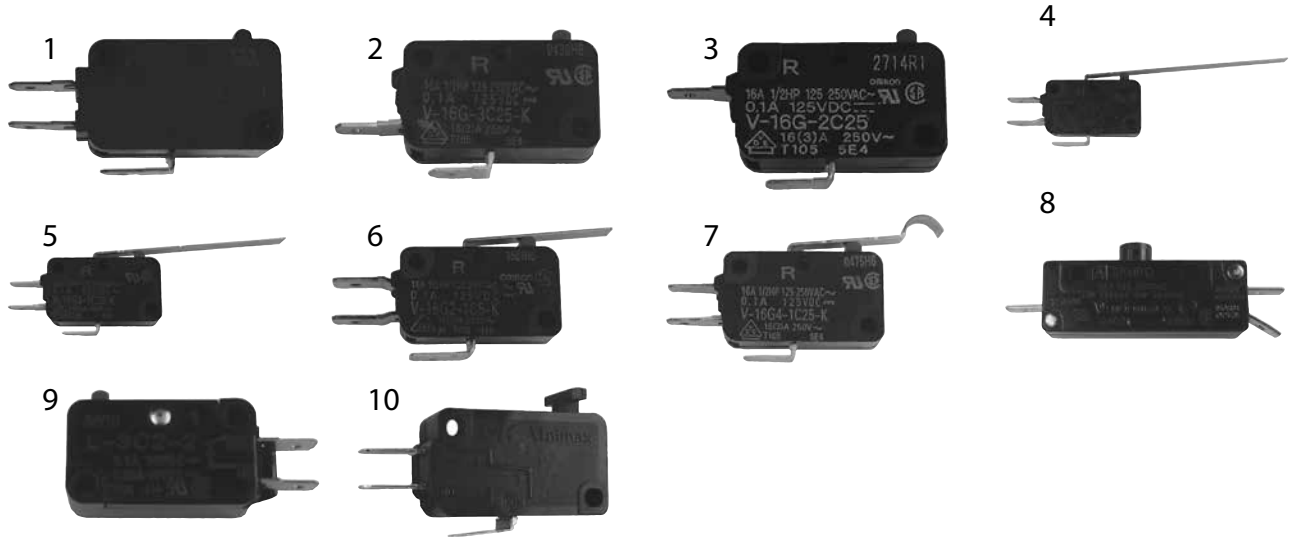

Pic	ERP#	Type	Application	Variety	Amp	Volt	Terminal	Lever Length	Lever Width
<b>Universal Replacement Parts</b>									
1	28QBP0491	Button	Universal	SPDT NO/NC	21	125/250	.020 x .187		
	28QBP0492	Button	Universal	SPDT NO/NC	21	125/250	.320 x .250		
	28QBP0493	Button	Universal Light Pressure	SPDT NO/NC	15	125/250	.020 x .187		
	28QBP0494	Button	Universal Light Pressure	SPDT NO/NC	15	125/250	.320 x .250		
	28QBP0495	Button	Universal	SPDT NO/NC	15	125/250	.020 x .187		
	28QBP0496	Button	Universal	SPDT NO/NC	15	125/250	.320 x .250		
	28QBP0540	Button	Lamp/Sensor	SPDT NO/NC	1	125	.020 x .187		
	28QBP0541	Button	Lamp/Sensor	SPDT NO/NC	1	125	.032 x .250		
2	28QBP0497	Button	Latch	SPST NO	15	125/250	.020 x .187		
	28QBP0498	Button	Latch	SPST NO	15	125/250	.320 x .250		
3	28QBP0499	Button	Monitor	SPST NC	15	125/250	.020 x .187		
	28QBP0500	Button	Monitor	SPST NC	15	125/250	.032 x .250		
4	28QBP0507	Extra Long Lever	Universal	SPDT NO/NC	15	125/250	.020 x .187	2-3/8"	5/32"
	28QBP0546	Extra Long Lever	Universal	SPDT NO/NC	15	125/250	.032 x .250	2-3/8"	5/32"
5	28QBP0503	Long Lever	Universal	SPST NC	15	125/250	.020 x .187	2"	5/32"
	28QBP0504	Long Lever	Universal	SPST NC	15	125/250	.032 x .250	2"	5/32"
6	28QBP0501	Short Lever	Universal	SPDT NO/NC	15	125/250	.020 x .187	1-1/16"	5/32"
	28QBP0502	Short Lever	Universal	SPDT NO/NC	15	125/250	.032 x .250	1-1/16"	5/32"
7	28QBP0505	Simulated Roller	Universal	SPDT NO/NC	15	125/250	.020 x .187	1-1/16"	5/32"
	28QBP0506	Simulated Roller	Universal	SPDT NO/NC	15	125/250	.032 x .250	1-1/16"	5/32"
8	28QBP0610	Commercial Duty	Commercial	SPDT NO/NC	25	125/250	.250		
<b>Exact Replacement Parts</b>									
9	28QBP0839	Replaces Panasonic Latch	Exact Replacement	SPST NO	3	277	.187		
10	28QBP0841	Replaces GE T Type (WB24X5167)	Exact Replacement	SPDT NO/NC	15	277	.187		



# THERMAL FUSES

Rated for continuous operating. Currents up to 10 amps @ 250VAC and 15 amps @ 120VAC. Open temperature tolerance +0°, -4°C. Used in microwave ovens, appliances, personal care products, office machines, portable heaters and industrial equipment. **Package of 4**



ERP #	°F	°C	ERP #	°F	°C	ERP #	°F	°C
22QBP072	162	72	22QBP121	250	121	22QBP216	421	216
22QBP077	171	77	22QBP128	262	128	22QBP228	442	228
22QBP084	183	84	22QBP144	291	144	22QBP240	464	240
22QBP093	199	93	22QBP152	306	152			
22QBP098	208	98	22QBP169	336	169			
22QBP104	219	104	22QBP184	363	184			
22QBP117	245	117	22QBP192	378	192			

Order No. CC18 (pkg of 12)

## Crimp Connectors



High temp - fits wire size #22-18AWG. Allows for easy replacement of thermal fuses. Eliminates heat problems when soldering thermal fuses. Just cut out thermal fuse leaving leads intact. Crimp in new thermal fuse with wire crimping tool.

Encased in electronically insulated case with 2 male spade terminals for easy field replacement. Rated 10 amp @ 250VAC, 15 amp @ 120VAC. Open temperature tolerance +0°, -4°C.

**Sold individually**

ERP #	°F	°C	Terminals
21QBP084V	183	84	1/4"
21QBP098V	208	98	1/4"
21QBP109V-1	228	109	1/4"
21QBP110V	230	110	1/4"
21QBP117V	243	117	1/4"
21QBP121V-1	250	121	3/16"
21QBP128V	262	128	1/4"
21QBP144V-1	291	144	3/16"
21QBP152V	306	152	1/4"
21QBP152V-1	306	152	3/16"



Encased thermal fuses - **special design**. Rated 15 amp @ 120VAC. **Sold individually**



ERP #	°F	°C	Terminals	Terminal Style
23QBP120V	248	120	1/4"	Vertical
23QBP120H	248	120	1/4"	Horizontal
23QBP140V	284	140	1/4"	Vertical
23QBP143V	289	143	1/4"	Vertical
23QBP145V	293	145	1/4"	Vertical
23QBP150H	302	150	1/4"	Horizontal

## FYI: Thermal fuses' nomenclature for ease of ordering

Standard prefix for thermal fuses  
 21 = Encased  
 22 = Non-encased  
 23 = Special design

**21QBP121V-1**

Temperature measured in °C

Terminal style  
 V = vertical  
 H = horizontal

Terminal size  
 -1 = 3/16"  
 no -1 = 1/4"

# TRANSFORMERS

## UNIVERSAL HV TRANSFORMERS

### Order No. 16QBP0293

Universal  
4.1 kV output (after doubling circuit)  
700-850 watts, 3.3 volt, 300mA  
Horizontal stack type  
3" H x 4-1/8" W x 3-7/8" D



Installation instructions (see wiring diagram on the next page)

1. Place transformer in position so that the label on top of the unit is correctly oriented and readable.
2. The two terminals located on the lower windings are the primary terminals for 120V line input.
3. The single terminal on the upper windings is the high voltage secondary terminal and is connected to the low side of the capacitor.
4. The flying lead located at the front of the unit is connected to the high side of the capacitor. The flying lead wire with the insulated terminal is connected to the "FA" terminal of the magnetron.

### Order No. 16QBP0296

Universal  
4.35 kV output (after doubling circuit)  
900-1000 watts, 3.2 volt, 350mA  
Horizontal stack type  
3-7/8" W x 5-1/4" D x 3-1/2" H



Installation instructions (see wiring diagram on the next page)

1. Place transformer in position so that the label on top of the unit is correctly oriented and readable.
2. The two terminals located on the lower windings are the primary terminals for 120V line input.
3. The single red wire off the backside of the upper windings is the high voltage secondary lead and is connected to the low side of the capacitor.
4. The two leads connected to the insulated terminal block are the filament leads and are connected to the filament terminal coming off of the magnetron. The single wire side is connected to the "FA" terminal. The flying lead coming out of the dual filament terminal block is connected to the high side of the capacitor (diode side).

### Wiring Instructions

Half-wave doubler L-C stabilized power supply circuit for typical microwave oven

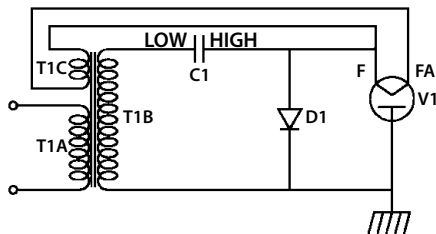

T1A	Transformer primary	C1	Capacitor
T1B	Transformer HV windings	D1	Diode
T1C	Transformer filament	V1	Magnetron tube

Wiring diagram for typical microwave oven power supply

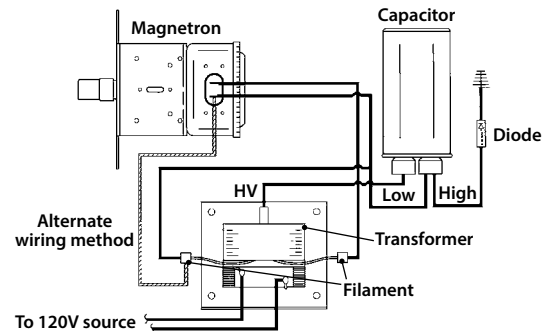

## EXACT REPLACEMENT HV TRANSFORMERS

### Order No. 16QBP4274

120 volt  
Horizontal stack type  
Replacement for Sharp



### Order No. 16QBP4374

120 volt  
Horizontal stack type  
Replacement for Sharp

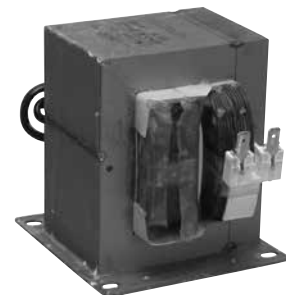

MICROWAVE

# THERMOSTATS

Applications include hi-limit cutoff thermostats for magnetrons and also as oven cavity safety thermostats. On an old thermostat, "N" & "S" denote temperature in °C, "L" denotes temperature in °F.

- Order No. 18QBP088H** 190°F - 88°C
- Order No. 18QBP093H** 199°F - 93°C
- Order No. 18QBP099H** 210°F - 99°C
- Order No. 18QBP110H** 230°F - 110°C
- Order No. 18QBP121H** 250°F - 121°C
- Order No. 18QBP127H** 261°F - 127°C
- Order No. 18QBP138H** 280°F - 138°C
- Order No. 18QBP145H** 293°F - 145°C
- Order No. 18QBP149H** 300°F - 149°C
- Order No. 18QBP160H** 320°F - 160°C

1/4" Horizontal Terminal Series  
 15 amp, 120 Volt  
 50° differential  
 Tolerance: open = -7°F, close ±12°F  
 Mounting holes are 25mm center to center



- Order No. 18QBP060V** 140°F - 60°C
- Order No. 18QBP077V** 171°F - 77°C
- Order No. 18QBP090V** 194°F - 90°C
- Order No. 18QBP094V** 201°F - 94°C
- Order No. 18QBP122V** 252°F - 122°C
- Order No. 18QBP135V** 275°F - 135°C
- Order No. 18QBP145V** 293°F - 145°C

1/4" Vertical Terminal Series  
 15 amp, 120 Volt  
 Mounting holes are 25mm center to center



- Order No. 18QBP090V-1** 194°F - 90°C
- Order No. 18QBP110V-1** 230°F - 110°C
- Order No. 18QBP122V-1** 252°F - 122°C
- Order No. 18QBP135V-1** 275°F - 135°C

3/16" Vertical Terminal Series  
 15 amp, 120 Volt  
 Mounting holes are 25mm center to center



- Order No. 18QBP110H-1** 230°F - 110°C
- Order No. 18QBP115H-1** 239°F - 115°C
- Order No. 18QBP135V-1** 275°F - 135°C

3/16" Horizontal Terminal Series  
 15 amp, 120 Volt  
 Mounting holes are 25mm center to center



## Order No. 18QBP180V-1W

Special Wide Mount Bracket Vertical  
 356°F - 180°C  
 1/4" terminals, 15 amp, 120 Volt  
 Mounting holes are 30mm center to center



- Order No. 18QBP120H-W** 248°F - 120°C
- Order No. 18QBP150H-W** 302°F - 150°C

Special Wide Mount Bracket  
 Horizontal  
 1/4" terminals, 15 amp, 120 Volt  
 Mounting holes are 30mm center to center



## FYI: Thermostats' nomenclature for ease of ordering

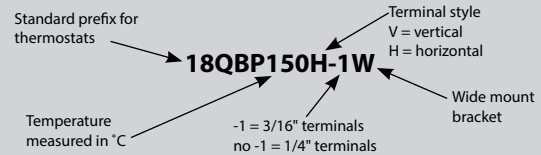

# TURNTABLE COUPLINGS

## Order No. 80QBP0571

Drive type: Square  
 Drive dia.: 15/16"  
 Shaft style: 1/4"  
 Double Flat  
 Shaft length: 7/16"  
 Replacement for Sharp



## Order No. 80QBP1352

Drive type: Square  
 Drive dia.: 15/32"  
 Shaft style: 1/4"  
 Double Flat  
 Shaft length: 3/4"  
 Replacement for Sharp



## Order No. 80QBP1771

Drive type: Square  
 Drive dia.: 7/16"  
 Shaft style: 1/4"  
 Double Flat  
 Shaft length: 3/4"  
 Replacement for Sharp



## Order No. 80QBP1781

Drive type: Tri-Wing  
 Drive dia.: 1-3/8"  
 Shaft style: 1/4" D  
 Shaft length: 5/8"  
 Replacement for Goldstar



## Order No. 80QBP2193

Drive type: Tri-Wing  
 Drive dia.: 1-1/4"  
 Shaft style: 1/4"D  
 Shaft length: 15/16"  
 Replacement for Panasonic

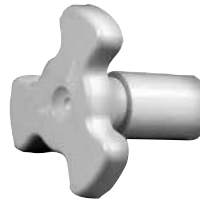

## Order No. 80QBP3112

Drive type: Tri-Wing  
 Drive dia.: 1-9/16"  
 Shaft style: 1/4"  
 Shaft length: 13/16"  
 Replacement for Samsung



## Order No. 80QBP4039

Drive type: Tri-Wing  
 Drive dia.: 1-3/8"  
 Shaft style: 1/4"D  
 Shaft length: 1/2"  
 Replacement for Goldstar

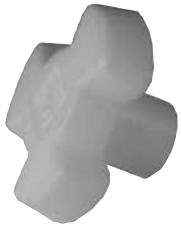

## Order No. 80QBP8387

Drive type: Round  
 Drive dia.: 1/4"  
 Shaft style: 5/16" X  
 Shaft length: 1-1/4"  
 Replacement for Sharp



## Order No. 80QBP8568

Drive type: Round  
 Drive dia.: 2"  
 Shaft style: 1/4"  
 Double Flat  
 Shaft length: 1"  
 Replacement for Sharp



## Order No. 80QBP8676

Drive type: Tri-Wing  
 Drive dia.: 1-1/4"  
 Shaft style: 1/4"D  
 Shaft length: 19/32"  
 Replacement for Goldstar



## Order No. 80QBP8695

Drive type: Tri-Wing  
 Drive dia.: 1-1/4"  
 Shaft style: 1/4"D  
 Shaft length: 1/2"  
 Replacement for Emerson



## Order No. 80QBP8786

Drive type: Tri-Wing  
 Drive dia.: 1-5/16"  
 Shaft style: 1/4"D  
 Shaft length: 9/16"  
 Replacement for Panasonic



## Order No. 80QBP9011

Drive type: Tri-Wing  
 Drive dia.: 2"  
 Shaft style: 1/4" D  
 Shaft length: 3/4"  
 Replaces GE #WB06X10138



# TURNTABLE/STIRRER MOTORS

## Order No. 15QB0111

120V - 2.8 W - 3 RPM  
Shaft length: 9/16"  
Shaft diameter: .275"

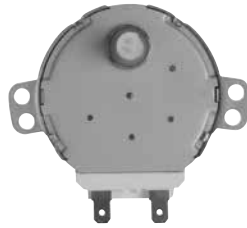

*Replacement for Goldstar*

## Order No. 15QB0122

21V - 3 W - 5/6 RPM  
Shaft length: 9/16"  
Shaft diameter: .275"



*Replacement for Goldstar*

## Order No. 15QB0192

120V - 2.7/2.4 W - 5/6 RPM  
Shaft length: 7/16"  
Shaft diameter: .265"  
Recessed shaft

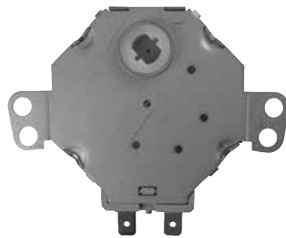

*Replacement for Sharp*

## Order No. 15QB0451

120V - 2.5 W - 3 RPM  
Shaft length: 3/8"  
Shaft diameter: .275"



*Replacement for Sharp*

## Order No. 15QB0685

120V - 2.5/2 W - 2.5/3 RPM  
Shaft length: 7/16"  
Shaft diameter: .275"



*Replacement for Emerson*

## Order No. 15QB0851

120V - 3/2.5 W - 5/6 RPM  
Shaft length: 5/8"  
Shaft diameter: .275"

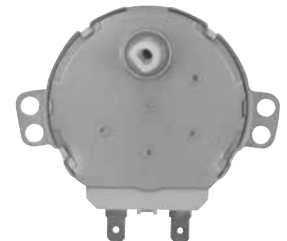

*Replacement for Panasonic*

## Order No. 15QB1017

21V - 3/2.5 W - 2.5/3 RPM  
Shaft length: 9/16"  
Shaft diameter: .275"



*Replacement for Samsung  
Replaces GE #WB26X10038*

## Order No. 15QB1344

120V - 3.3/2.8 W - 2.5/3 RPM  
Shaft length: 17/32"  
Shaft diameter: .312"

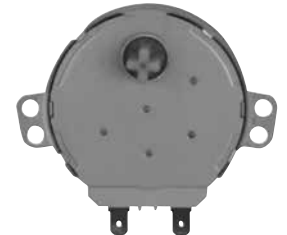

*Replacement for Sharp*

## Order No. 15QB3596

120V - 2.8 W - 34.9 RPM  
Shaft length: 7/8"  
Shaft diameter: 3/16"



*Replacement for Goldstar*

## Order No. 15QB3932

21V - 3 W - 5/6 RPM  
Shaft length: 5/8"  
Shaft diameter: .275"



*Replacement for Samsung  
Replaces GE #WB26X10024*

# TURNTABLE/STIRRER MOTORS

## Order No. 15QBP4118

120V - 2 W - 3 RPM

**NEW!**

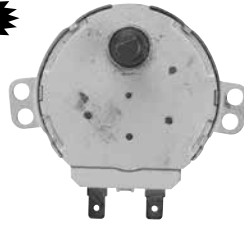

Replaces GE #WB26X10025

## Order No. 15QBP4166

21V - 3 W - 2.5/3 RPM  
Shaft length: 7/16"  
Shaft diameter: .275"



Replacement for Goldstar

## Order No. 15QBP4184

120V - 2.1 W - 3 RPM  
Shaft length: 1/4"  
Shaft diameter: 1/4"



Replacement for Sharp

## Order No. 15QBP4185

120V - 2 W - 6 RPM  
Shaft length: 7/16"  
Shaft diameter: .275"

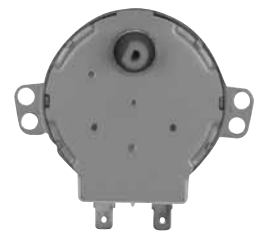

Replacement for Sharp

## Order No. 15QBP4186

120V - 4 W - 6 RPM  
Shaft length: 1/2"  
Shaft diameter: .275"

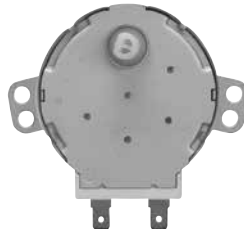

Replacement for Panasonic

## Order No. 15QBP4204

120V - 2.8 W - 6 RPM  
Shaft length: 7/16"  
Shaft diameter: .275"



Replacement for Goldstar  
Replaces GE #WB26X10082,  
Whirlpool #W10192843

## Order No. 15QBP4227

21V - 3 W - 29.1/34.9 RPM  
Shaft length: 7/8"  
Shaft diameter: 3/16"

**NEW!**

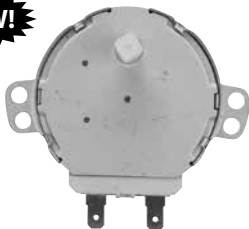

Replaces GE #WB26X10037

## Order No. 15QBP4228

120V - 3 W - 2.5/3 RPM  
Shaft length: 1/2"  
Shaft diameter: 1/4"

**NEW!**

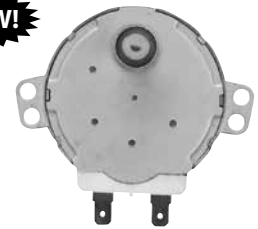

Replaces GE #WB26X10041

## Order No. 15QBP4235

100-120V - 4 W - 5/6 RPM  
Shaft length: 3/8"  
Shaft diameter: 1/4"

**NEW!**

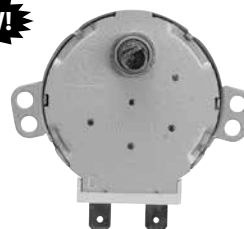

Replaces Whirlpool #8183954

## Order No. 15QBP4237

120V - 3 RPM  
Shaft length: 1/2"  
Shaft diameter: 1/4"

**NEW!**

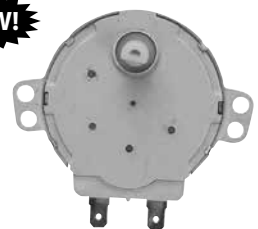

Replaces GE #WB26X10168



# TURNTABLE SUPPORTS

## Order No. 80QBP1021

Tri-wing - Plastic shaft  
 4-13/16" ring radius  
 9/16" roller diameter  
 1/4" X roller type  
 5/8" shaft length  
 Replacement for  
 Sharp



## Order No. 80QBP1110

Tri-wing - Plastic shaft  
 4-13/16" ring radius  
 9/16" roller diameter  
 5/16" X roller type  
 1/2" shaft length  
 Replacement for  
 Sharp



## Order No. 80QBP1219

Roller Ring - Plastic  
 8-3/16" diameter  
 9/16" roller diameter  
 Replacement for  
 Sharp



## Order No. 80QBP1287

Tri-wing - Plastic shaft  
 5-1/2" ring radius  
 9/16" roller diameter  
 5/8" 8pt star roller type  
 3/8" shaft length  
 Replacement for  
 Sharp



## Order No. 80QBP1602

Roller Ring - Plastic  
 7-1/4" diameter  
 11/16" roller diameter  
 Replacement for Goldstar



## Order No. 80QBP2831

Tri-wing - Metal shaft  
 5-3/8" ring radius  
 11/16" roller diameter  
 5/16" Sq. roller type  
 Replacement for  
 Sharp



## Order No. 80QBP3142

Tri-wing - Metal shaft  
 6-1/4" ring radius  
 15/16" roller diameter  
 Replacement for Sharp



## Order No. 80QBP3199

Tri-wing - Plastic shaft  
 4-1/4" ring radius  
 3/4" roller diameter  
 Large D  
 9/16" shaft length  
 Replacement for  
 Samsung

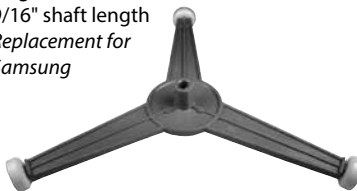

## Order No. 80QBP3644

Tri-wing - Plastic shaft  
 4-1/2" ring radius  
 9/16" roller diameter  
 1/4" X roller type  
 1/2" shaft length  
 Replacement for  
 Sharp



## Order No. 80QBP3689

Tri-wing - Metal shaft  
 5-3/16" ring radius  
 5/8" roller diameter  
 5/16" Sq. roller type  
 Replacement for  
 Sharp



## Order No. 80QBP4011

Tri-wing - Plastic shaft  
 3-15/16" ring radius  
 9/16" roller diameter  
 1/4" D roller type  
 9/16" shaft length  
 Replacement for Goldstar



## Order No. 80QBP7139

Roller Ring - Plastic  
 7-1/4" diameter  
 9/16" roller diameter  
 Replacement for Panasonic



# TURNTABLE SUPPORTS

## Order No. 80QBP7160

Roller Ring - Plastic  
9-7/8" diameter  
9/16" roller diameter  
*Replacement for Goldstar*



## Order No. 80QBP7161

Tri-wing - Plastic shaft  
4-5/8" ring radius  
9/16" roller diameter  
1/4" D roller type  
1/2" shaft length  
*Replacement for Goldstar*



## Order No. 80QBP8541

Tri-wing - Plastic shaft  
4-7/16" ring radius  
9/16" roller diameter  
1/4" X roller type  
5/8" shaft length  
*Replacement for Sharp*

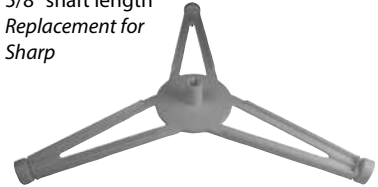

## Order No. 80QBP8598

Roller Ring - Plastic  
7-3/4" diameter  
9/16" roller diameter  
*Replacement for Samsung*



## Order No. 80QBP8609

Roller Ring - Plastic  
9-1/2" diameter  
1/2" roller diameter  
*Replacement for Goldstar*



## Order No. 80QBP8633

Tri-wing - Plastic shaft  
4-7/16" ring radius  
9/16" roller diameter  
1/4" X roller type  
5/8" shaft length  
*Replacement for Sharp*

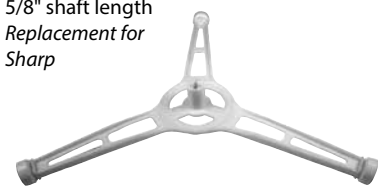

## Order No. 80QBP8654

Roller Ring - Plastic  
9-15/16" diameter  
9/16" roller diameter  
*Replacement for Panasonic*



## Order No. 80QBP8701

Tri-wing - Plastic shaft  
4-3/4" ring radius  
11/16" roller diameter  
1/4" D roller type  
11/16" shaft length  
*Replacement for Goldstar*



## Order No. 80QBP8717

Tri-wing - Plastic shaft  
5-1/2" ring radius  
9/16" roller diameter  
1/4" D roller type  
21/32" shaft length  
*Replacement for Goldstar*



## Order No. 80QBP8723

Tri-wing - Plastic shaft  
4-3/8" ring radius  
9/16" roller diameter  
1/4" D roller type  
9/16" shaft length  
*Replacement for Goldstar*



## Order No. 80QBP8819

Roller Ring - Plastic  
9-5/8" diameter  
5/8" roller diameter  
*Replacement for Goldstar*



## Order No. 80QBP8929

Tri-wing - Plastic shaft  
4-3/4" ring radius  
9/16" roller diameter  
9/32" D roller type  
13/32" shaft length  
*Replacement for Goldstar*

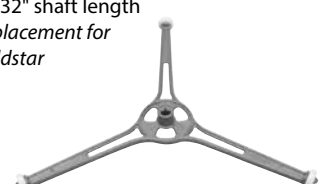

# TURNTABLE TRAYS

## Tray Drives

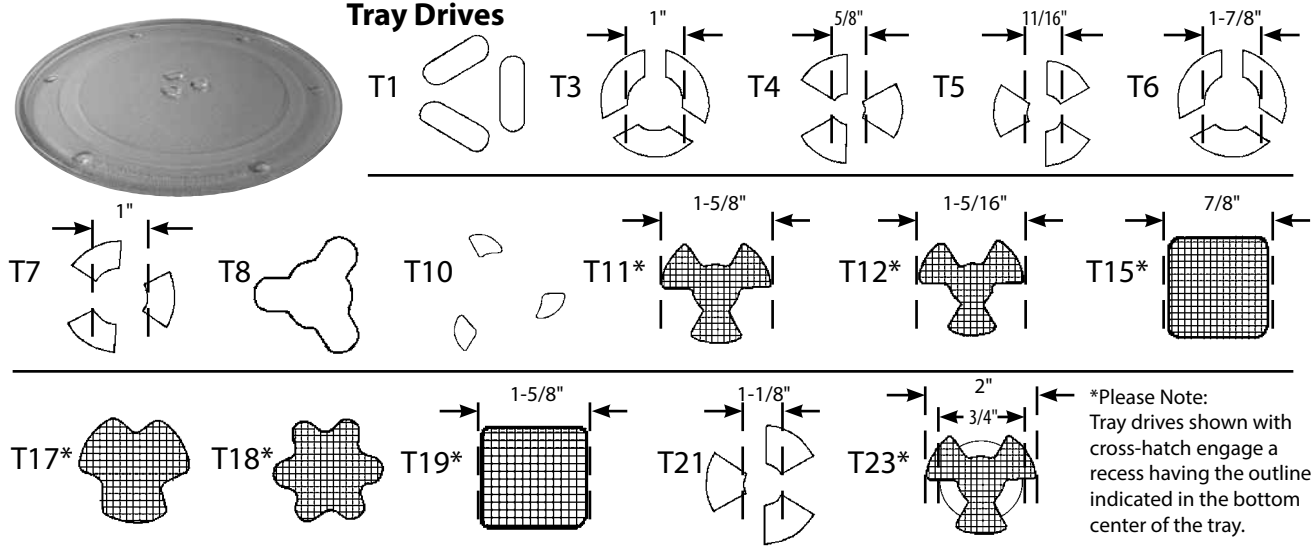

\*Please Note:  
Tray drives shown with  
cross-hatch engage a  
recess having the outline  
indicated in the bottom  
center of the tray.

Dia.	ERP#	Drive	Track ID	Track OD	Ridge ID	Ridge OD	Description
9-5/8"	30QBP2525		6-1/2"	7-5/8"	7-5/8"		Has 3 small rectangular feet, 6-7/8" apart
9-5/8"	30QBP4117	T4	6-3/4"	7-1/16"	7-1/16"		Has 3 small rectangular feet, 6-7/8" apart
10"	30QBP4110	T21	7-1/2"	8-5/8"			
10-1/16"	30QBP4143	T23	6-15/16"	9-1/8"			Has 3 feet 1/4" high, 5-3/16" center - center
10-1/4"	30QBP1252		6-7/16"	7-9/16"	7-9/16"		Has 3 small rectangular feet on ridge
10-5/8"	30QBP2278	T23	7"	9"			Has 3 feet, 5-1/4" apart, 3/16" high
10-5/8"	30QBP3019	T11	7"	8-5/8"			Has 3 feet, 5-1/4" apart
10-3/4"	30QBP0057		8"	9"	9"		Slightly raised 2" diameter circle in center
11-1/4"	30QBP1002		8"	9-1/8"	9-1/8"	10"	
11-3/8"	30QBP3675	T7	7"	8-7/8"			Has 3 feet, 5-1/8" apart
11-5/8"	30QBP1111		8-1/4"	8-7/8"	8-7/8"		Has 1 ridged and track raised, track ID bevelled
NEW! 11-7/8"	30QBP4185	T6	7-7/8"	9"			Replacement for Whirlpool #4393799
11-15/16"	30QBP2415	T5	8"	10-7/16"			
12"	30QBP0649	T5	7-5/8"	9-3/8"			
12"	30QBP1145		8"	9-1/4"			Has 3 feet (dashes) 1/64" high, 8" center - center
12"	30QBP1768	T3	8"	9"			
12"	30QBP4111	T5	8"	10-3/8"			
12"	30QBP4160	T7	7-3/4"	9"	9"		Has 3 feet, 1/8" high, 8-3/4" center - center
12-7/16"	30QBP0793	T5	7-1/8"	8-7/16"			Has 3 feet, 5-1/2" apart, 3/16" high
12-7/16"	30QBP4124	T5	3-3/16"	9-5/8"			Has 3 feet at 3-16" high, 5-1/2" center - center
12-7/16"	30QBP4145	T5	7-3/16"	10"	10"		Has 3 feet at 1/4" high, 5-1/2" center - center
12-1/2"	30QBP1848	T7	8-1/4"	10-1/4"			Has 3 feet, 6-5/16" apart, 3/16" high Replacement for GE #WB39X10003
12-5/8"	30QBP0254	T5	8"	11-1/8"			
12-5/8"	30QBP1274		7-3/4"	8-7/8"			Has small rectangular feet, 8" apart

# TURNTABLE TRAYS

See previous page for drive tray profiles

Dia.	ERP#	Drive	Track ID	Track OD	Ridge ID	Ridge OD	Description
12-5/8"	30QBP2418		8-1/16"	9-1/4"	9-1/4"		Has 3 small rectangular feet on ridge
12-3/4"	30QBP0663	T5	8-1/4"	11-1/4"			
12-7/8"	30QBP3538				10-1/2"		White ceramic
13"	30QBP4026		8-11/16"	9-3/4"		9-3/4"	Has 3 small rectangular feet on ridge
13-1/4"	30QBP0901	T3	7-7/8"	8-7/8"			Has 3 feet, 9-3/4" apart, 3/16" high
13-1/4"	30QBP3031	T3	7-7/8"	8-7/8"	8-7/8"		OD on ridge is tapers, 3 round feet, 9-1/4" apart
13-3/8"	30QBP4119	T5	8"	11"			Has 3 tapered feet, 6" apart, 7/32" high
13-3/8"	30QBP4163	T5	8-15/16"	11-1/4"	11-1/4"		
13-9/16"	30QBP0331	T5	8-1/4"	10-7/8"			Has 3 feet, 6-5/16" apart, 3/16" high
13-5/8"	30QBP2782	T7	8-1/4"	10-1/4"			Has 3 round glass feet, 6-3/8" apart, 1/4" high
14-1/8"	30QBP0766	T5	9-3/4"	11"			Has 3 feet, 7-3/4" apart, 1/8" high
14-3/16"	30QBP0349		9-5/8"	10-7/8"		10-7/8"	No feet, rests on raised ridge
14-3/16"	30QBP4099		8"	9-1/4"		9-1/4"	Has 3 small rectangular feet on ridge
14-3/16"	30QBP4107		8-5/8"	9-3/4"		9-3/4"	Has 3 small rectangular feet on ridge
14-3/16"	30QBP4630	T7	8-1/4"	10-1/4"			Has 3 feet, 6-3/8" apart, 5/16" high
15-1/8"	30QBP0064	T10	9-7/8"	11-7/8"			Has 3 rectangular feet, 11-1/2" apart, 5/16" high
15-3/8"	30QBP0055		8"	9"	10-1/4"	11-3/8"	
15-3/8"	30QBP2375				12-1/2"	14-1/4"	Metal, black with white speckles
15-5/8"	30QBP2198		8-3/8"	9-5/8"			
16"	30QBP0350		8"	9-3/16"		9-3/16"	Has 3 small rectangular feet on ridge
16"	30QBP1000		8-3/4"	9-5/8"			
16"	30QBP4087		8-11/16"	9-5/8"		9-5/8"	Has 3 small rectangular feet on ridge
16-9/16"	30QBP4126	T5	9-3/4"	11"			Has 3 tapered feet, 7-5/8" apart, 5/32" high

## Order No. 30QBP2567

15-3/4" length x 13-1/32" width  
 3/4" thick  
 Sides slightly curved  
 4-5/8" x 5/8" x 3/16" deep slot in center of tray bottom



## Order No. 30QBP0041

10-1/2" length x 10-1/2" width

## Order No. 30QBP0604

14-1/2" length x 13-5/8" width (white ceramic)

## Order No. 30QBP0566

15-3/4" length x 15-7/16" width



# WAVEGUIDES & STIRRER COVERS

**Order No. 40QBP1012** 12" L x 10" W  
**Order No. 40QBP1618** 18" L x 16" W

Cut-to-fit  
Mica construction

**UNIVERSAL REPLACEMENT**



**Order No. 29QBP0478**

4-3/8" L x 2-27/32" W  
Mica construction  
*Replacement for Sharp*



**Order No. 29QBP1951**

4-11/16" L x 3-1/16" W  
Mica construction  
*Replacement for Sharp*



**Order No. 29QBP2569**

9-5/16" diameter  
Mica construction with plastic shaft  
*Replacement for Sharp*



**Order No. 29QBP4093**

8-3/4" diameter  
Mica construction  
Includes metal fan disc  
*Replacement for Goldstar*

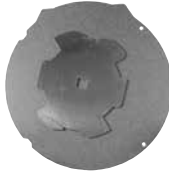

**Order No. 40QBP0461**

4-7/8" L x 4-5/8" W  
Mica construction  
*Replacement for Sharp*



**Order No. 40QBP0480**

4-11/16" L x 4-3/16" W  
Mica construction  
*Replacement for Sharp*



**Order No. 40QBP0482** 4-9/16" L x 4-1/16" W  
**Order No. 40QBP0720** 4-5/8" L x 4-1/8" W

Mica construction  
*Replacement for Sharp*



**Order No. 40QBP0484**

5-1/2" L x 4-5/16" W  
Mica construction  
*Replacement for Sharp*



**Order No. 40QBP0485**

4-3/8" L x 4-1/16" W  
Mica construction  
*Replacement for Sharp*

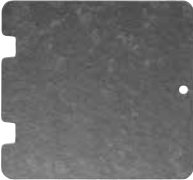

**Order No. 40QBP0715**

4-3/4" L x 4-3/16" W  
Mica construction  
*Replacement for Sharp*



**Order No. 40QBP0737**

4-3/16" L x 3-27/32" W  
Mica construction  
*Replacement for Sharp*

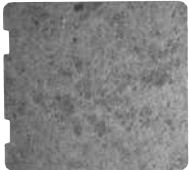

**Order No. 40QBP0739**

5-3/32" L x 4-9/32" W  
Mica construction  
*Replacement for Sharp*



**Order No. 40QBP1155**

4-9/32" L x 2-11/16" W  
Mica construction  
*Replacement for Panasonic*



**Order No. 40QBP1399**

4-5/8" L x 3-7/8" W  
Mica construction  
*Replacement for Emerson*



MICROWAVE

# WAVEGUIDES & STIRRER COVERS

## Order No. 40QBP1706

4-5/8" L x 4-1/32" W  
Mica construction  
Replacement for  
Sharp



## Order No. 40QBP3849

4-9/16" L x 4-3/32" W  
Mica construction  
Replacement for  
Sharp



## Order No. 40QBP4144

4-15/32" L x 4-7/8" W  
Mica construction  
Replacement for  
Goldstar

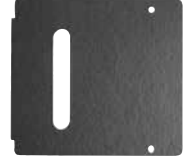

## Order No. 40QBP4189

5-9/32" L x 5-1/2" W  
Mica construction  
Replacement for  
Sharp



## Order No. 40QBP4197

4-23/32" L x 4-7/32" W  
Mica construction  
Replacement for  
Sharp

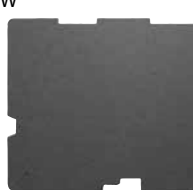

## Order No. 40QBP4200

5-1/2" L x 4-3/8" W  
Mica construction  
Replacement for  
Goldstar



## Order No. 40QBP4201

4-11/16" L x 4-7/32" W  
Mica construction  
Replacement for Sharp



## Order No. 40QBP4203

8-1/2" L x 8-1/2" W  
Mica construction  
with plastic shaft  
Replacement for Sharp



## Order No. 80QBP0723

Waveguide cover retainer canoe clip  
Pin head: .281"  
Width: .155"  
Length: .365"  
Universal Replacement



## Order No. 80QBP0761

Waveguide cover retainer canoe clip  
Pin head: .308"  
Width: .140"  
Length: .330"  
Universal Replacement



## Order No. 80QBP0895

Waveguide cover retainer canoe clip  
Pin head: .420"  
Width: .236"  
Length: .590"  
Sold in packs of 100  
Universal Replacement



## Order No. 80QBP0898

Waveguide cover retainer push pin  
Pin head: .315" width: .134" length: .312"  
Receptacle dia: .191" Shaft length: .220"  
Qty: 2 expansion pins  
Universal Replacement

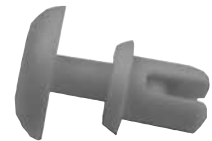



# MICROWAVE MISCELLANEOUS

**Order No. 80QBP1432**

**Door Open Lever**

4-3/8" L  
1-1/8" W  
1-3/16" D

Replacement for Sharp



**Order No. 80QBP3117**

**Door Open Lever**

4-1/2" L  
1-1/2" W  
1-9/16" D

Replacement for Sharp



**Order No. 80QBP3483**

**Door Open Lever**

3-1/4" L  
1-1/2" W  
1-3/4" D

Replacement for Panasonic



**Order No. 80QBP7677**

**Door Open Lever**

4-1/2" L  
1-3/8" W  
1" D

Replacement for Sharp



**Order No. 80QBP8817**

**Door Open Lever**

3-3/8" L  
2-1/8" W  
1-1/2" D

Replacement for Panasonic



**Order No. 80QBP3119**

**Rack Support**

13/16" L x 1/2" W x 1" D

Plastic  
Replacement for Goldstar



**Order No. 82QBP0102**

**Rack Support**

3/4" L x 9/16" W x 15/16" D

Plastic  
Replacement for Goldstar



**Order No. 82QBP0117**

**Rack Support**

25/32" L x 15/32" W x 23/32" D

Plastic  
Replacement for Samsung



**Order No. 80QBP1421**

**Spring**

7/8" length  
5/8" diameter  
Replacement for Sharp



**Order No. 80QBP1496**

**Latch Spring**

1-1/4" length  
1/4" diameter  
Replacement for Sharp



**Order No. 17QBP2172**

**Thermistor**

Replacement for Sharp



**Order No. 17QBP2971**

**Thermistor**

Replacement for Sharp



# MICROWAVE MISCELLANEOUS

## Order No. 80QBP1468

### Select Button

White  
5" L x 1-7/16" W x 3/4" D  
Replacement for Sharp

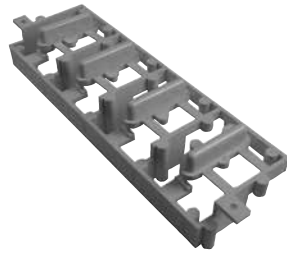

Used on models:  
R1501, R1506, R1511

## Order No. 80QBP8675

### Select Button

Black  
5" L x 1-7/16" W x 3/4" D  
Replacement for Sharp

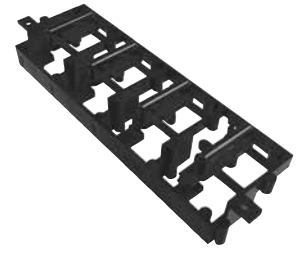

Used on models:  
R1500, R1505, R1510

## Order No. 80QBP8712

### Select Button

Almond  
5" L x 1-7/16" W x 3/4" D  
Replacement for Sharp

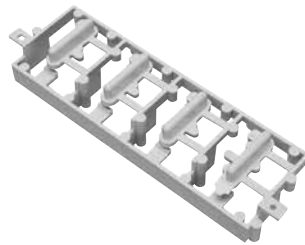

Used on models:  
R1502, R1512

## Order No. 80QBP1220

### Body Latchboard

6-9/32" length  
2-27/32" width  
15/16" depth  
Replacement for  
Panasonic



## Order No. 80QBP3931

### Body Latchboard

8-11/32" length  
2-11/16" width  
1-3/8" depth  
Replacement for  
Sharp

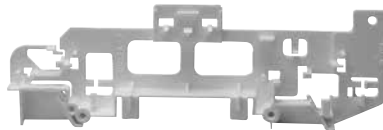

## Order No. 80QBP8240

### Body Latchboard

9-5/8" length  
2-3/8" width  
1-5/16" depth  
Replacement for  
Sharp



## Order No. 80QBP8337

### Body Latchboard

8-5/8" length  
3-1/4" width  
1-1/4" depth  
Replacement for  
Sharp

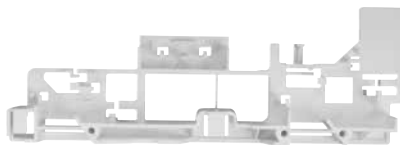

## Order No. 80QBP8750

### Body Latchboard

10-7/8" length  
2-7/16" width  
1-5/8" depth  
Replacement for  
Sharp



## Order No. 83QBP1516

### Universal Door Sheets

Cut-to-fit clear plastic sheets  
with adhesive on one side.  
16" L x 15" W

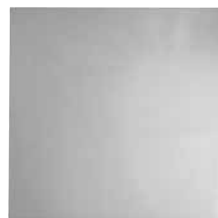

## Order No. 17QBP0260

### Varistor

Voltage: 120  
Applied Voltage: 130  
Clamping Voltage: 340  
Amps: 4500  
Energy: 38 joules/2MS  
Universal Replacement



# MICROWAVE MISCELLANEOUS

## Order No. 14QBP0100

### Fuse Holder

20 amp • 250 volt  
3/16" male terminals  
Holds:  
1-1/4" L x 1/4" dia.  
ceraminc/glass fuse



Used on **Panasonic, Quasar**  
Has black molded base

## Order No. 14QBP0101

### Fuse Holder

30 amp • 300 volt  
1/4" male terminals  
Holds:  
1-1/4" L x 1/4" dia.  
ceraminc/glass fuse



Used on **Sanyo, Samsung**  
Has gray molded base

## Order No. 14QBP0105

### Fuse Holder

20 amp • 300 volt  
3/16" male terminals  
Holds:  
1-1/4" L x 1/4" dia.  
ceraminc/glass fuse



Used on **Goldstar**  
Has locator pin

## FUSE/SWITCH KITS

Sharp recommends that the monitor switch and CT fuse be replaced together. The following chart shows the complete kit order number as well as the order numbers for the individual components of the kit.

ERP Kit #	Fuse #	Switch #
FSWK012	14QBP20CSB	28QB0499
FSWK015	14QBP15CFB	28QB0499
FSWK016	14QBP20CFB	28QB0499



ERP Kit #	Fuse #	Switch #
FSWK020	24QBP13A120H	28QB0499



ERP Kit #	Fuse #	Switch #
FSWK018	24QBP15A150V	28QB0499

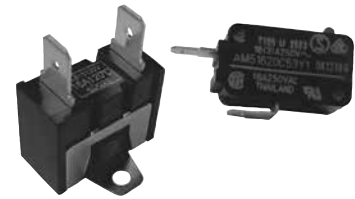

## Order No. 26QB0106

### Inverter

Replaces **Panasonic**  
#A606Y6G00AP  
#F606Y6F00AP

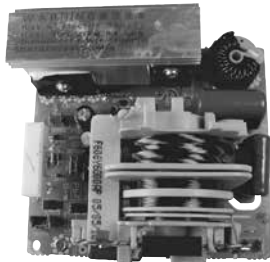

**WARNING:** The inverter board looks like a regular printed circuit board, but is actually a high voltage/high current device. This PCB replaces the high voltage transformer, high voltage capacitor and high voltage diode used in ordinary microwaves. It supplies the approximate 4000V DC needed to put the magnetron into oscillation. As with all microwave parts, repairs should only be done by qualified technicians. Do not touch circuit even when off, high voltage current may remain in the circuit. Do not touch aluminum heat sink, it becomes extremely hot. Do not attempt to adjust or repair the inverter board. Only replace it by following the manufacturer's recommended instructions.

## Order No. 4750

### Magic Lights Microwave Tester

- Checks microwave power settings
- Finds hot and cold spots
- No batteries needed



## Order No. MLM240

### Microwave Radiation Detector

- Checks radiation levels
- Simple and cost efficient warning device
- No batteries required
- 2" L x 1-3/8" W x 3/4" H
- Gauge with "Safety" and "Danger" zones, display immediate results



# DISHWASHER

## ELECTROLUX

Order No. ER154174501

Roller

**NEW!**



Order No. ER154637401

Water Valve

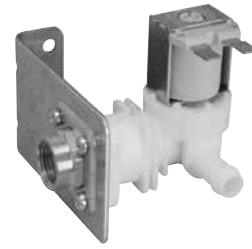

Order No. ER154665201

Element  
15-1/2" x 15-1/2" with  
male spade terminals

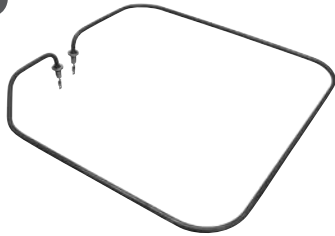

Order No. ER5300809703

Spring



## GENERAL ELECTRIC

Order No. ERGEDWM

Mech Motor  
ERP pump motor assemblies are 100% run & water  
tested for quality.  
Fits GE/Hotpoint dishwashers from 1971 to current.  
Also fits: WD26X77, WD26X10007, WD26X10011, WD26X10013

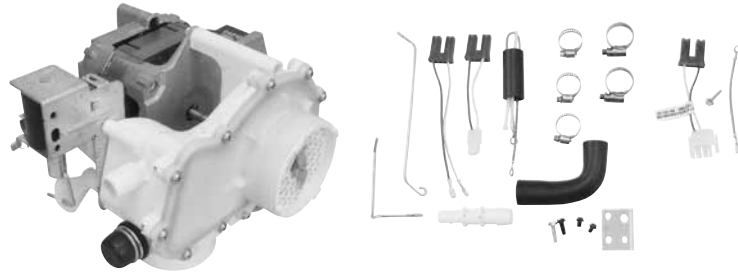

Order No. ERWD7X14

Cable  
8" length



Order No. ERWD8X181

Flapper Valve Shaft Seal  
For old style GE dishwasher  
motor/pump assemblies  
WD26X74 & WD26X77  
Replaces GE #WD8X181



Order No. ERWD8X227

Right Corner Gasket  
Also fits: DW156



Order No. ERWD8X228

Left Corner Gasket  
Also fits: DW157



DISHWASHER

# DISHWASHER

## GENERAL ELECTRIC

Order No. ERWD08X10057

Gasket  
89-1/2" length  
5/8" tall

**NEW!**



Order No. ERWD8X229

Gasket  
89" length, 3/8" tall  
Replaces GE #WD8X229  
Maytag #2450-0025

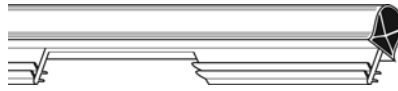

Order No. ERWD9X212

Timer Knob



front

side

Order No. ERWD12X258

Lower Rack Roller  
Green  
1-1/4" dia.  
5/8" wide

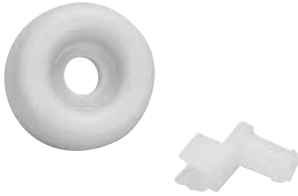

Order No. ERWD12X271

Roller with stud  
White  
1-3/4" diameter  
3/4" wide  
Also fits: DW604

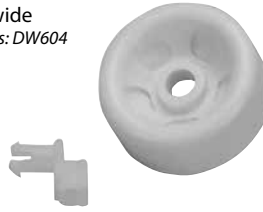

Order No. ERWD12X383

Rack Roller Kit

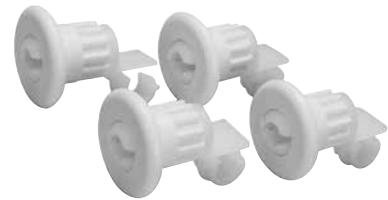

Order No. ERWD12X10074

Lower Rack Roller



Order No. ERWD12X10136

Lower Rack Roller



Order No. ERWD12X10267

Roller with stud



Order No. ERWD12X10277

Roller Shaft



Order No. ERWD12X10304

Endcap

**NEW!**



Order No. ERWD15X10004

Water Valve

**NEW!**

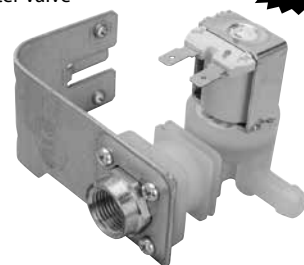

# DISHWASHER

## GENERAL ELECTRIC

Order No. ERWD15X10010

Water Valve

**NEW!**

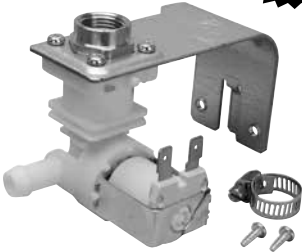

Order No. ERWD15X10011

Water Valve

**NEW!**

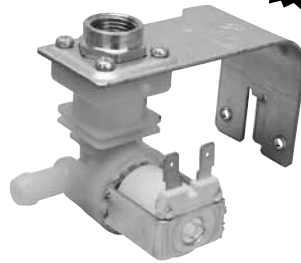

Order No. ERWD19X44

Support Nut  
Replaces GE  
#WD19X44



Order No. ERWD19X10032

Pump Impeller Kit  
Also fits:  
WD19X62, DW105



Order No. ERWD21X10060

Solenoid Kit

**NEW!**



Order No. ERWD22X71

Spray Arm Hub  
Narrow hub with bearings  
Also fits: DW113



Order No. ERWD22X114

Spray Arm Support  
Supports with side valve  
Also fits: DW111



Order No. ERWD22X120

Spray Tower  
Power shower with five  
threads on bottom  
Also fits: DW112



Order No. ERWD24X10018

Piston & Nut Assembly



Order No. ERWD28X10230

Upper Rack

**NEW!**

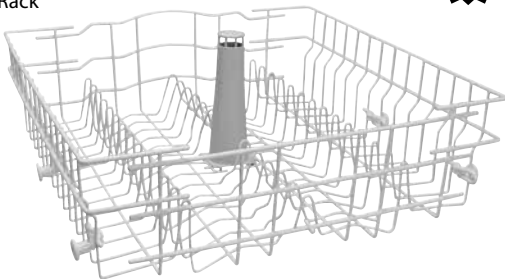

Order No. ERWD28X10335

Lower Rack

**NEW!**

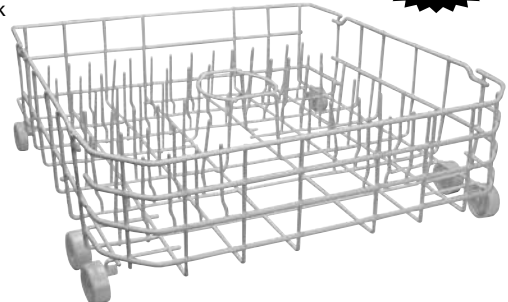

DISHWASHER



# DISHWASHER

## WHIRLPOOL

Order No. ER34FHT

Inlet



Order No. ER3376846

Seal



Order No. ER4162321

Rack Axle



Order No. ER4162322

Roller



Order No. ER9742945

Nut



Order No. ER9742946

Bearing



Order No. ER4163075

Drain Valve



Order No. ER675611

Spring



Order No. ER675796

Thermal Fuse

**NEW!**



Order No. ER675813

Thermal Fuse

**NEW!**



Order No. ER8193762

Fuse Kit

**NEW!**

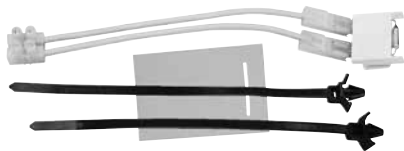

Order No. ERW10258275

Thermal Fuse

**NEW!**

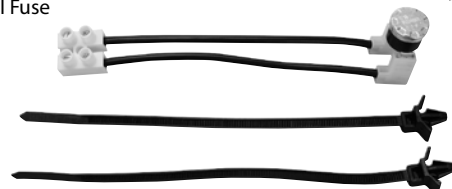

# DISHWASHER

## WHIRLPOOL

Order No. ERW10134017

Sensor



Order No. ERW10134009

Element



Order No. ER8194001

Link Kit



Order No. ERW10158291

Link



Order No. ER303650

Water Valve

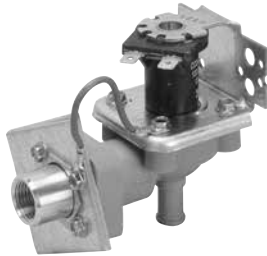

Order No. ER8531669

Water Valve



Order No. ER8531670

Water Valve



Order No. ER8531671

Water Valve



Order No. ERW10158387

Water Valve

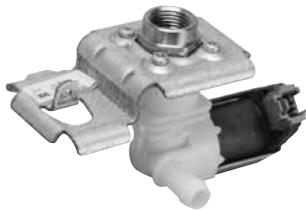

Order No. ERW10158389

Water Valve



# DISHWASHER

## MISCELLANEOUS

Order No. ER425458

Water Valve

**NEW!**



Replaces: Bosch #425458

Order No. ER607335

Water Valve

**NEW!**



Replaces: Bosch #607335

Order No. ER5221DD1001A

Water Valve

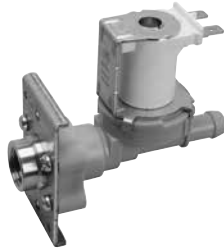

Replaces: LG #5221DD1001A

Order No. ERDW-1

Universal Valve

Kit contains:

- 5 watt coil (blue)
- 10 watt coil (black)
- 4 flow washers (black, blue, green, yellow)

Uses existing brackets & mounting hardware  
Thorough instructions with OEM  
cross reference information

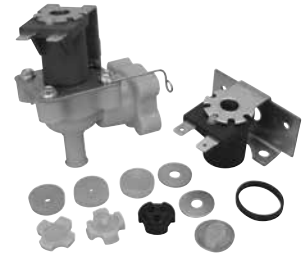

Order No. ERUDWD2

Universal Dispenser  
\*Color may vary

**NEW!**

Replaces:

Electrolux #154230104, #154542103,  
#154542104, #154542107, #154574401,  
#154574405, #1548610101, #154860103,  
#5304452518, #5304460911, #5304475588,  
GE #WD12X10163, #WD12X10174, #WD12X10205,  
#WD12X10220, #WD12X10237, LG #4924FD2123E



FRONT



BACK

Order No. DWDH78

Universal Drain/Extension Hose

- 1/2" ID x 78" length
- Barbed section allows the hose to adapt to the newer Whirlpool/Kenmore machines and can be cut & used as extension hose



End



Molded Barbed Section

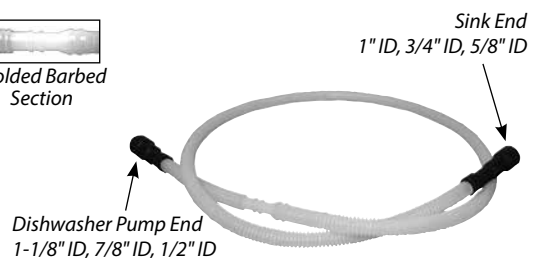

Sink End  
1" ID, 3/4" ID, 5/8" ID

Dishwasher Pump End  
1-1/8" ID, 7/8" ID, 1/2" ID

Order No. DWIP72

Universal Water Inlet Tubing

- 3/8" tubing, 72" length
- Fits 3/8" & 1/2" male compression fittings and 1/2" FIP male fittings
- Made of PEX Tubing
- Resistant to kinks, chlorine, chloramines and typical household cleaners

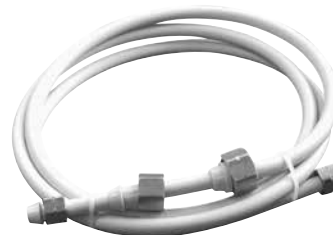

Water Supply End



Dishwasher End

# DISHWASHER

## MISCELLANEOUS

### Order No. GL12N (4 oz. box)

Glisten Dishwasher Cleaner  
Non-toxic, citric acid mixture.  
Removes iron/manganese from walls of dishwasher.  
Removes soap scum, rust & stains connected with well water.



### Order No. 19500

Glisten Rinse Aid  
Keeps dishwashers smelling fresh for 21 days.



### Order No. DM06N

Dishwasher Magic  
Sold as 6PK CASE ONLY  
• Removes mineral build-up, disinfects & cleans dishwasher  
• Extends life and improves performance  
• Safe for all dishwasher models, plumbing & septic systems  
• Environmentally friendly



### Order No. DM24F

24 piece floor display



### Order No. DM12D

12 piece counter display



### Order No. DWR-B (blue)

### Order No. DWR-GY (gray)

### Order No. DWR-W (white)

Dishwasher Rack Repair  
• "Guardcote" plastic repair material  
• Touch-up bottle includes brush  
• Dries in 24 hours



### Order No. ERDWLC

Drain Hose Connector End



### Order No. ERHP363

Drain Hose  
Bulk 5/8" x 50 ft.



### Order No. ERDW7

Drain Hose  
5/8" x 7 ft.  
Has adaptable  
5/8", x 5/8", 3/4" or  
1-1/4" connector

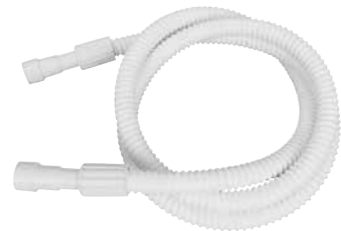

### Order No. ER1010A

Disposal Splash Guard  
Fits: In-Sink-Erator  
Models 333/SS & 77



### Order No. ER1010B

Disposal Splash Guard  
Fits: In-Sink-Erator Models  
Badger 1, Badger V and  
Model 333  
Replaces Ez-Flo  
#30102



# DISHWASHER

## MISCELLANEOUS

### Order No. 19010

- Plink Disposer Lemon Cleaner/Deodorizer
- Breaks up fat & food particles
  - Helps prevent clogging
  - Freshens your whole kitchen



### Order No. 31316 14 oz.

- Antibacterial Dispos'l Clean
- Citrus scented
  - Kills bacteria
  - Fills the entire disposal cavity to clean, deodorize & disinfect
  - Non-acid, non-abrasive formula
  - Safe for plumbing and septic systems



### Order No. DP06NPB

1 packet

### Order No. DP46TPB

Counter display (6 packets)

### Order No. DP424F

Floor display (24 packets)

- Garbage Disposal Cleaner
- Cleans & deodorizes garbage disposal
  - Scrubs away food, grease & odors, leaving a pleasant lemon fresh scent
  - No mess, no clean up, just drop in
  - 4 cleaning packets



### Order No. B36C

- Disposer Brush
- Sturdy, round base cleans the bottom of the disposal
  - Ergonomically designed T-handle twists back and forth
  - Works on 90% of waste disposal systems
  - 11" long x 4-1/2" dia.
  - Made in USA



### Order No. DE32N Liquid, 32oz.

- Drain Out® Clog Remover
- Professional strength liquid formula contains twice the active ingredients of most clog removers
  - Liquefies fats, grease oil, hair & other organic matter
  - Cleans & deodorizes drains



HAZMAT ORM-D regulations apply

### Order No. DC12N Crystal, 2 lbs.

- Drain Out® Clog Remover
- Commercial grade drain & sewer opener
  - Churns through toughest organic obstructions in sewers, grease traps & drains
  - Ideal substitute for organic acid



HAZMAT ORM-D regulations apply

### Order No. 080402-B (QB58028)

- Handy Hook
- Gets debris out of drains
  - Removes hair in seconds
  - No harmful chemicals
  - Made in USA



### Order No. 13350

- Paper Compactor Bags
- 2 ply 9" x 17" x 16" bags
  - Wet-strength paper plus plastic liner resists puncture & moisture
  - Fits most compactors
  - Pre-cuffed for secure mounting
  - Reinforced, bonded bottom
  - 12 per pack



# DRYER PARTS

ERP Dryer Belts feature Multi-rib and Flat designs that duplicate OEM performance.

## BELT PROFILES

**BAREBACK**

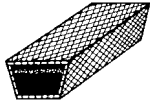

**COGGED**

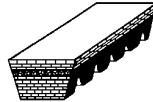

**FLAT**

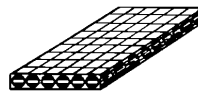

**LAMINATED**

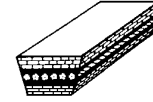

**MULTI-V**

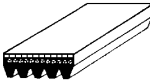

**NOTCHED**

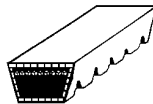

**ROUND**

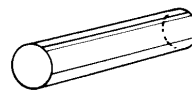

**WRAPPED**

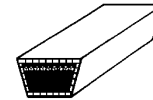

## BELT SPECIFICATIONS

OEM	ERP #	Reference #	Belt Type
<b>Bosch</b>	ER437367		Multi-V <b>NEW!</b>
<b>Electrolux</b>	ER134719300		Multi-V <b>NEW!</b>
	ER137292700	LB298	Multi-V
	ER5303161099	LB202	Multi-V
	ER5303281154	LB260	Flat
	ER5308057424	LB210	Multi-V
<b>GE</b>	ERWE12X36	LB215	Multi-V
	ERWE12X46*	LB218	Multi-V
	ERWE12X49	LB217	Multi-V
	ERWE12X82	LB216	Multi-V
<b>Samsung</b>	ER6602-01655		Multi-V <b>NEW!</b>
	ERDC66-00121A		Multi-V <b>NEW!</b>
<b>Whirlpool</b>	ER311012*	LB230	Bareback
	ER311013*	LB231	Bareback
	ER312544	LB235	Multi-V
	ER312959	LB234	Multi-V
	ER313328	LB236	Multi-V

OEM	ERP #	Reference #	Belt Type
<b>Whirlpool</b>	ER33002535	LB279	Multi-V
	ER337019	LB274	Multi-V
	ER337388	LB275	Multi-V
	ER3394652	LB278	Multi-V
	ER341241	LB276	Multi-V
	ER35001010		Multi-V <b>NEW!</b>
	ER356402	LB280	Multi-V
	ER40111201	LB254	Multi-V
	ER56095	LB270	Multi-V
	ER8183101		Multi-V <b>NEW!</b>
	ER8544742		Multi-V <b>NEW!</b>
	ER8547157		Multi-V <b>NEW!</b>
	ER8547168		Multi-V <b>NEW!</b>
	ER902115	LB233	Multi-V
	ERW10136934		Multi-V <b>NEW!</b>
	ERW10205415		Multi-V <b>NEW!</b>

\* NLA from OEM



# DRYER PARTS

ERP Universal "L" Style thermostats are UL recognized. Open on Rise.

## UNIVERSAL THERMOSTATS

ERP #	Adjustable Range	
ERAT012	L135°F - L175°F	Limit
ERAT013	L175°F - L215°F	Limit
ERAT014	L210°F - L250°F	Limit
ERAT015	L250°F - L290°F	Limit
ERAT021	F90°F - F130°F	Fan
ERAT022	F140°F - F180°F	Fan

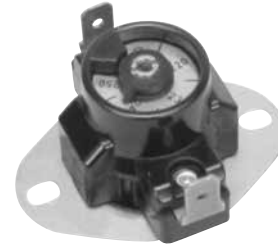

**ERTA014**

ERP #	CI	CO	Differential
ERL120	120°F	110°F	10°F
ERL125	125°F	115°F	10°F
ERL130	130°F	115°F	15°F
ERL135	135°F	120°F	15°F
ERL140	140°F	130°F	10°F
ERL145	145°F	125°F	20°F
ERL150	150°F	130°F	20°F
ERL155	155°F	135°F	20°F
ERL160	160°F	120°F	40°F
ERL165	165°F	120°F	45°F
ERL170	170°F	130°F	40°F
ERL175	175°F	135°F	40°F
ERL180	180°F	170°F	10°F

ERP #	CI	CO	Differential
ERL190	190°F	150°F	40°F
ERL200	200°F	160°F	40°F
ERL205	205°F	165°F	40°F
ERL225	225°F	185°F	40°F
ERL240	240°F	200°F	40°F
ERL250	250°F	210°F	40°F
ERL260	260°F	210°F	50°F
ERL270	270°F	230°F	40°F
ERL290	290°F	250°F	40°F
ERL300	300°F	250°F	50°F
ERL320	320°F	270°F	50°F
ERL340	340°F	300°F	40°F



**ERL225**

## ELECTROLUX

### Order No. ER01167943

Roller Kit  
Complete with nylon bearings.  
Used on Kelvinator, Gibson and  
Electrolux dryers.  
NLA from Electrolux



Also fits: #DE697, #8014029, #F133006

### Order No. ER131825900

Bearing  
Replacement bearing for rear  
drum. For 27" models to present.



Also fits: #DE727, #Q143951

# DRYER PARTS

## ELECTROLUX

Order No. ER131476300

Blower Wheel

**NEW!**



Order No. ER131689300

Dryer Knob  
White, 1-1/2" diameter  
1/8" ext. shaft - 6 o'clock flat

**NEW!**



Order No. ER131873500

Dryer Knob  
White, 2-3/8" diameter  
1/8" recessed shaft - 6 o'clock flat

**NEW!**



Order No. ER134011703

Dryer Timer Knob  
Graphite knob with grey indicators  
1/4" ext. shaft - 6 o'clock flat

*Functionally replaces:  
#134011701 (white w/blue indicators)  
#134011700 (black w/blue indicators)*



Order No. ER134034911

Dryer Knob  
Almond  
1-1/2" diameter  
1/16" ext. shaft  
6 o'clock flat



Order No. ER134034971

Dryer Knob  
Almond  
1-1/2" diameter  
3/8" ext. shaft  
6 o'clock flat



Order No. ER134844410

Dryer Knob  
White  
1-1/2" diameter  
1/8" ext. shaft  
6 o'clock flat



Order No. ER134844412

Dryer Knob  
Black  
1-1/2" diameter  
Flush shaft  
6 o'clock flat



Order No. ER134844413

Dryer Knob  
White  
1-1/2" diameter  
1/8" ext. shaft  
6 o'clock flat



Order No. ER134844470

Dryer Knob  
White  
1-1/2" diameter  
1/4" ext. shaft  
6 o'clock flat



Order No. ER134886700

Laundry Knob  
Flush shaft  
6 o'clock flat



LAUNDRY

# DRYER PARTS

## ELECTROLUX

Order No. ER134196600

Motor

**NEW!**

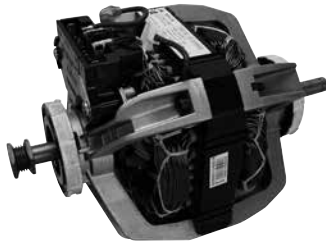

Order No. ER137115900

Motor

**NEW!**



Order No. ER5300622032

Dryer Element

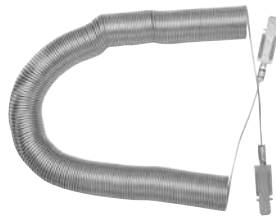

Order No. ER5300622034

Dryer Element

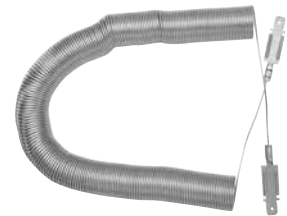

Order No. ER5303161103

Idler Pulley  
Pulley only. For 24" laundry centers  
NLA from Electrolux



Also fits: #DE413

Order No. ER5303212849

Idler Pulley  
Metal bracket with nylon pulley  
for use with Electrolux dryers



Used with: #ER5303281153 belt

Order No. ER5303281049

Lower Front Seal  
For Electrolux 27" gas  
& electric dryers



Order No. ER5303937139

Front Drum Glides  
For Electrolux gas & electric dryers  
Includes adhesive



Order No. ER5303937182

Felt Seal

**NEW!**



Order No. ER5303937183

Felt Seal

**NEW!**



# DRYER PARTS

## ELECTROLUX

Order No. ER5303281153

Drum Bearing



Also fits: #DE724

Order No. ERBPS22

Seal All

- Contact adhesive & sealant
- 1 fl. oz.
- Quick drying
- Gas & oil resistant



Order No. ERDE382

Primary & Secondary Coil Kit  
Replaces #5303931775 coil kit  
for "M" series valves



Order No. ER279570

Door Latch  
Replaces #5366021400 for  
gas & electric dryers



Also fits: #DE902

Order No. ERWE4X444

Dryer Igniter  
Replaces #5304440277



Order No. ERUDI

Universal Dryer Igniter  
Includes hardware & installation instructions for  
replacement of flat & spiral hot surface igniters

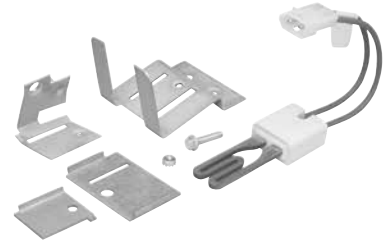

Replaces #5300600831, #5303937186, #5304440277

## LG

Order No. ER4581EL2002A

Drum Roller



**NEW!**

Order No. ER5301EL1001G

Dryer Element



Replaces: LG #5301EL1001G

Order No. ER6931EL3001E

Dryer Thermostat



Order No. ER6931EL3003D

Dryer Thermostat



# DRYER PARTS

## GENERAL ELECTRIC

Order No. ERWE1M654

Dryer Knob  
2-3/4" diameter  
1/8" ext. shaft  
12 o'clock flat  
White with black pointer

**NEW!**



Order No. ERWE1X1263

Dryer Knob  
2-7/8" diameter  
1/8" ext. shaft  
12 o'clock flat  
White with red pointer



Order No. ERWE1X1264

Dryer Knob  
2-7/8" diameter  
1/8" ext. shaft  
12 o'clock flat  
Almond with black pointer



Order No. ERWE1X1269

Dryer Knob  
1-3/8" diameter  
1/8" ext. shaft  
3 o'clock flat  
Black with white dot



Order No. ERWE3M19

Front Drum Bearing



Also fits: #WE3M19

Order No. ERWE3M26

Front Drum Bearing



Also fits: #WE3M26

Order No. ERDE382

Primary & Secondary Coil Kit  
Replaces #WE4X692 and  
#WE4X693 with one part  
number

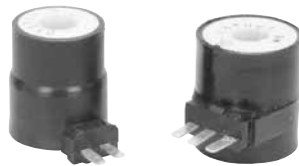

Order No. ERWE3X75

Drum Bearing  
New style bearing with flange



Also fits: #DE726, #WE3X37

Order No. ERWE04X10111

Thermistor



**NEW!**

Order No. ERWE04X10114

Thermistor

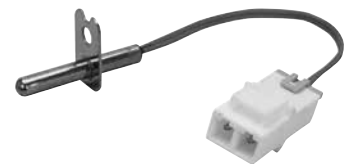

**NEW!**

# DRYER PARTS

## GENERAL ELECTRIC

Order No. ERWE4X444F

Dryer Igniter  
Flat style

**ECONOMY**

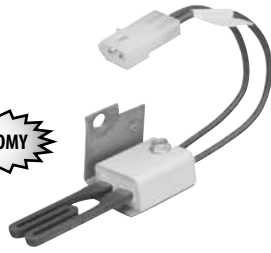

ERP offers two choices to replace GE #WE4X444

Order No. ERWE4X444

Dryer Igniter  
Round style

**EXACT**



Order No. ERWE4X739

Dryer Igniter Bracket  
Replaces #WE4X739,  
#DE358, #SDE358



Order No. ERWE4X750

Dryer Igniter



Order No. ERUDI

Universal Dryer Igniter  
Includes hardware & installation instructions for replacement of flat & spiral hot surface igniters

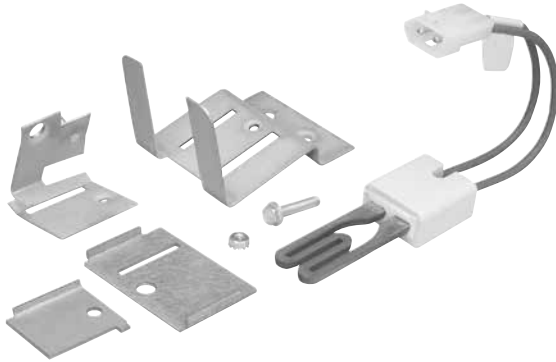

Replaces #WE4X444, #WE4X739, #WE4X750

Order No. ERWE12X81

Idler Pulley  
Used on most GE/Hotpoint gas & electric dryers



Also fits: #DE401, #WE12X81

Order No. ERWE13X68

Slide Repair  
Kit includes: 1 slide, 1 felt packaging and 2 rivets to repair one side.  
Used from 1965-2002.



Also fits: #DE729

Order No. ERWE1M333

Drum Slide

**NEW!**



Order No. ERWE1M481

Drum Slide

**NEW!**

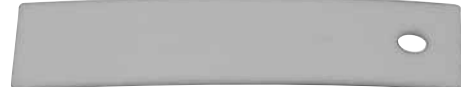

LAUNDRY



# DRYER PARTS

## GENERAL ELECTRIC

Order No. ERWE11M21C

Dryer Element

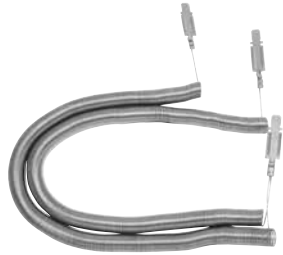

Order No. ERWE11M23

Dryer Element

**NEW!**



Order No. ERWE11X103

Dryer Element

**NEW!**



Order No. ERWE11X203

Dryer Element



Order No. ERWE11X260

Dryer Element

**NEW!**

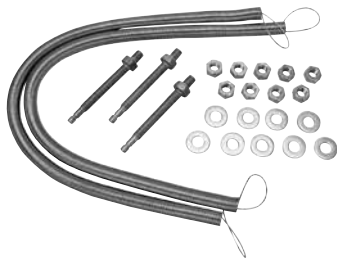

Order No. ERWE11X10007C

Dryer Element

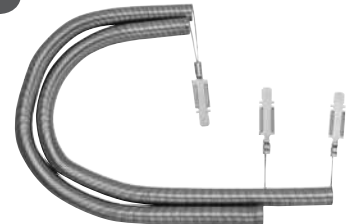

Order No. ERWE18X26 (Plastic)  
Order No. ERWE18X26M (Metal)

Lint Screen  
For gas & electric dryers



Also fits: #DE520

Order No. ERWE25X60

Slide Kit  
Kit includes: 2 drum slides,  
screws & lubricant. For  
gas & electric dryers from  
1960-2002.

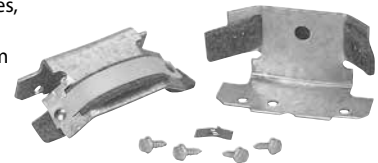

Also fits: #DE731

Order No. ERWE25X205

Drum Bearing Kit  
Complete kit for gas &  
electric dryers. GE dryers  
built from 1961-2002.  
Hotpoint dryers built from  
1968-2002.



Also fits: #DE725, #WE25X62

Order No. ERWE4X800

High Limit Thermostat



# DRYER PARTS

## WHIRLPOOL

**Order No. ER279640**

Idler Pulley



**Order No. ER303705**

Idler Pulley  
For Maytag gas & electric dryers  
manufactured since 1978.  
Used with #ER312959 belt.



*Replaces Whirlpool #6-3037050  
Also fits: #DE405*

**Order No. ER691366**

Idler Pulley  
Replaces #681366 &  
#3394322 idler pulleys  
for Whirlpool dryers



*Also fits: #DE411, #DE412*

**Order No. ER12001541**

Roller  
For Maytag gas & electric dryers  
manufactured since 1984



**Order No. ER303373K**

Roller  
Replacement for Maytag roller kit  
includes assembled roller, shaft,  
fiberwashers and retainer clips



**Order No. ER31001096**

Roller with Bushing  
Replacement for Norge  
dryers since 1988



**Order No. ER349241**

Drum Roller  
For Whirlpool gas & electric dryers.  
Includes 2 tri-rings.



*Also fits: #DE501*

**Order No. ER349241T**

Drum Roller  
For Whirlpool gas & electric dryers.  
Includes 4 tri-rings.



*Also fits: #DE501*

**Order No. ERLA1007**

Front Roller Kit  
Replacement left front support for  
Norge dryers, includes roller, shaft  
& retainers.  
*NLA from Whirlpool*



**Order No. ERLA1008**

Rear Roller Kit  
Norge rear roller kit  
includes: 2 #ER31001096  
rollers & shafts.

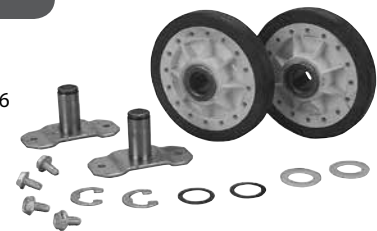

# DRYER PARTS

## WHIRLPOOL

Order No. ER4392065

Dryer Rebuild Kit  
Contains #ER349241T,  
#ER691366, #ER341241  
& Instructions



Order No. ER8536974

Drum Support Roller  
Heavy duty style



Order No. ER279787

Dryer Motor  
1-1/4" drive shaft

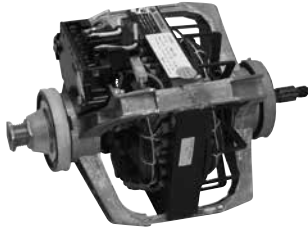

Order No. ER279827

Dryer Motor  
1-3/4" drive shaft

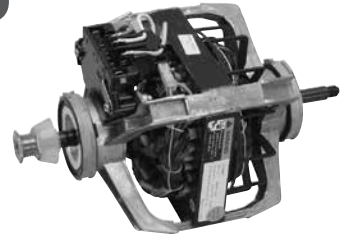

Order No. ER312948

Roller Shaft  
For Maytag gas  
& electric dryers  
manufactured  
since 1984



Replaces Whirlpool #6-3129480

Order No. ER279311

Dryer Igniter  
Replaces #4391996

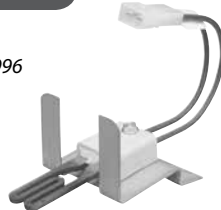

Order No. ER31001556

Dryer Igniter



Order No. ERWE4X444

Dryer Igniter  
Replaces #4392003



Order No. ERUDI

Universal Dryer Igniter  
Includes hardware & installation instructions for  
replacement of flat & spiral hot surface igniters

Replaces #239300, #279311, #3-4970, #303376, #304970,  
#37001308, #4391996, #40069801P, #55438, #56970, #60868, #686590

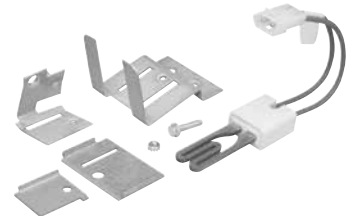

Order No. ER303836

Blower Wheel

Replaces Whirlpool #Y303836  
Also fits: #DE602



Order No. ER31001043

Blower Wheel

Also fits: #DE343



# DRYER PARTS

## WHIRLPOOL

Order No. ER279838

Dryer Element



Order No. ER303404

Dryer Element

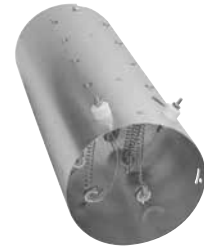

Replaces Whirlpool #Y303404

Order No. ER3387747

Dryer Element

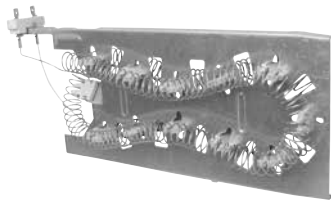

Order No. ER4391960

Dryer Element

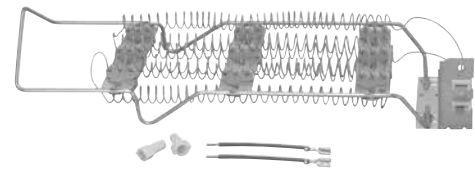

Order No. ER61927

Dryer Element



Order No. ER8544771

Dryer Element

**NEW!**

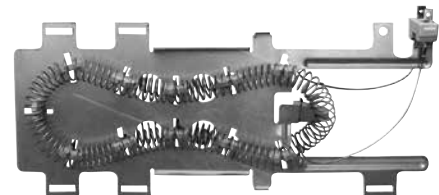

Order No. ERLA1044

Dryer Element

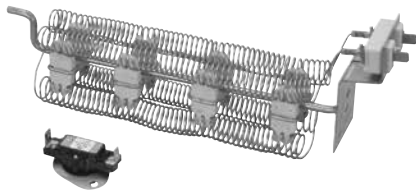

Order No. ERY311946

Dryer Element

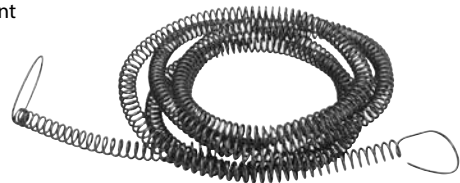

Order No. ER688865

Knob  
Chrome plated plastic knob for Whirlpool  
gas & electric dryers up to 1985



Also fits: #DE501

Order No. ER35001150

Moisture Sensor

**NEW!**



# DRYER PARTS

## WHIRLPOOL

Order No. ER53-0701

Lint Screen



Order No. ER53-0918

Lint Screen



Order No. ER339392

Lint Screen  
Replacement lint filter for standard & commercial gas & electric  
dryers produced since 1964. Screen size: 7-1/8" x 17-5/8"



Also fits: #DE522, Whirlpool #690634

Order No. ER349639

Lint Screen



Order No. ER8531964

Lint Screen



Order No. ER8557882

Lint Screen

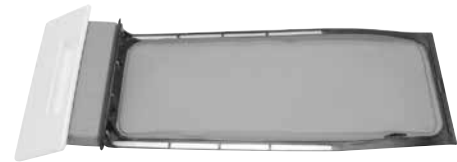

Also fits: Whirlpool #348851

Order No. ER8557884

Lint Screen



Order No. ER33001003

Lint Screen



Order No. ER33001808

Lint Screen



Order No. ER33002970

Lint Screen



Order No. ERW10120998

Lint Screen

**NEW!**



# DRYER PARTS

## WHIRLPOOL

Order No. ER279769

High Limit Thermostat  
Kit includes one high limit thermostat & one thermo cut-off. Used on electric dryers from 1985-1995.

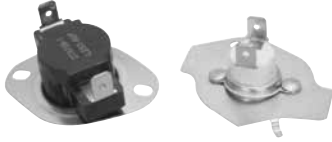

Also fits: #ET401

Order No. ER303395

High Limit Thermostat



Order No. ER303396

High Limit Thermostat



Order No. ER3387134

Thermostat  
L155-25 with 120V  
heat anticipator



Also fits:  
GE #WE4X856  
Supco #L15525W

Order No. ER3390291

Thermostat  
L250-80F



**NEW!**

Order No. ER35001092

Thermostat  
L260-50F



**NEW!**

Order No. ER397767

Thermostat  
L221-65F



Order No. ER53-0771

Thermostat  
L248



Replaces Supco #SET176

Order No. ER53-1096

Thermostat  
L240



Replaces Supco #SET404

Order No. ERLA1053

Thermostat  
Includes #ER53-0771,  
#ER53-1096, #ER53-1182

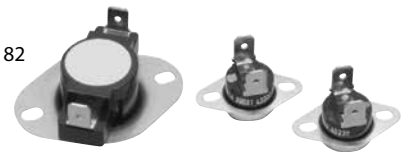

Replaces #53-0771, Supco #SET405



# DRYER PARTS

## WHIRLPOOL

### Order No. ERDE382

Primary & Secondary Coil Kit  
Replaces #279834, #306106,  
#306105 coils for "M" style  
gas valves

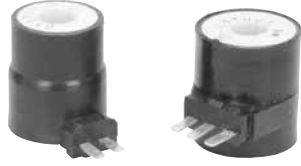

### Order No. ER3390719

Thermal Fuse Kit  
Replacement single blow fuse



Also fits: #ET402

### Order No. ER3392519

Thermal Fuse Kit  
Replacement single blow fuse



Also fits: #ET401, #3392519, #3388651

### Order No. ER3399849

Thermal Fuse



### Order No. ER279816

Thermal Cut Off Kit



### Order No. ER197

Thermal Cut Off Kit (Old version)

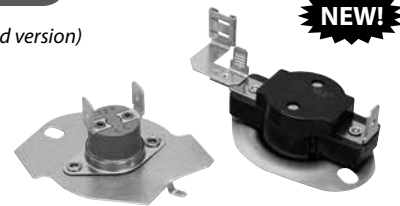

### Order No. ER53-1182

Thermal Fuse  
L300



Replaces Supco #SET403

### Order No. ERR9900489

Thermal Fuse Kit

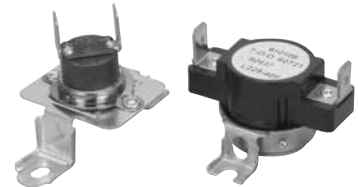

### Order No. ER35001191

Thermistor



**NEW!**

### Order No. ER8577274

Thermistor



# DRYER PARTS

## WHIRLPOOL

Order No. ER338906

Flame Sensor

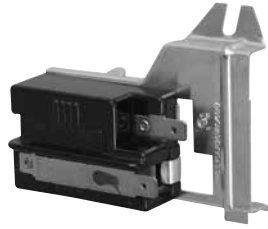

Order No. ER3406105

Door Lid Switch

**NEW!**

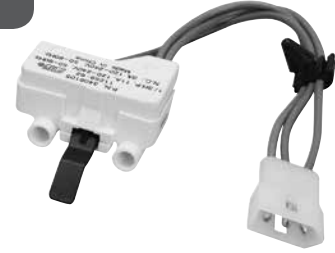

Order No. ER3406107

Door Start Switch



Order No. ER279347

Lid Switch & Actuator  
Used on some washers also

Also fits: #LP210

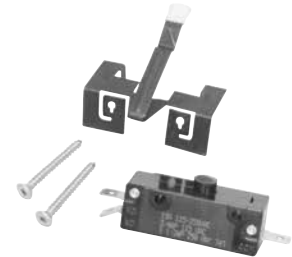

Order No. ER691581

Bracket

Also fits: #LP985



Order No. ER279570

Door Latch  
Popular door latch used  
in many dryers. Molded  
plastic latch & strike.

Also fits: #DE902



Order No. ER279570M

Door Latch  
With metal striker

Also fits: #DE902M

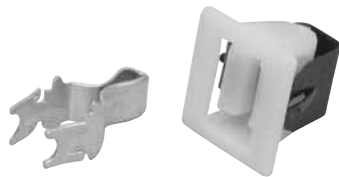

Order No. ER279393

Nut & Bolt Kit



Order No. ER3405281

Motor Relay

**NEW!**



Order No. ER9703438

Snap Ring

**NEW!**



LAUNDRY

# DRYER PARTS

## WHIRLPOOL

Order No. ER33313541

Tumbler Seal



Order No. ER306508

Drum Slide Package  
Includes rivets, cork & slide  
for Maytag dryers

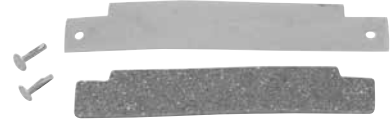

Also fits: #DE747

Order No. ERLA1006

Glide Kit  
Right front glide  
& cushion for  
Norge & Magic  
Chef dryers



Order No. ER239087 82" long, 26" dia. Also fits: #DE737

Order No. ER279408 79" long, 25" dia. Also fits: #DE268

Order No. ER279735 72" long, 23" dia.

Rear Drum Seal  
with adhesive

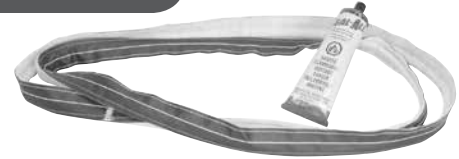

Order No. ER279264

Drum Seal Kit with adhesive  
Replaces drum support and  
front drum seal on gas &  
electric dryers since 1964



Also fits: #DE735

Order No. ER33002803

Dryer Timer

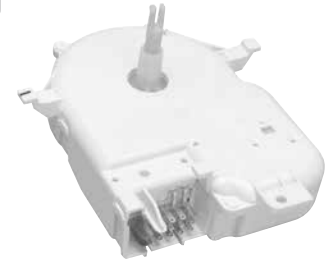

Order No. ER33002808

Dryer Timer

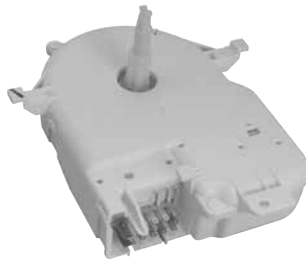

Order No. ER33002854

Dryer Timer



Order No. ER33002855

Dryer Timer



Order No. ER505797P

Dryer Timer

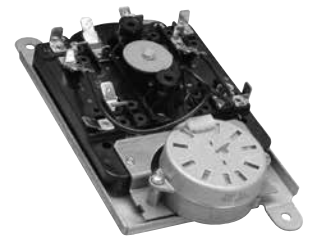

# DRYER PARTS

## Order No. DVC202

- Removes lint build-up
- Helps prevent dryer fires
- Saves money on utility bills
- Lengthens the life of dryer
- The MOST valuable tool for ensuring safe operation of dryers
- Effectively cleans all types of dryer vents (metal, foil, while vinyl)



## What's included in this 9 piece kit



(1) Self-Feeding 4" Auger Brush  
Makes multiple turns in vent.  
*Replacement brush also available separately.*  
**Order No. AB412**

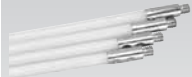

(4) 36" Flexible Rods  
Screw together to reach into vents up to 12' from one end.  
*Additional rods available.*  
**Order No. EXT12FT**



(1) Large 2.5" dia. Lint Brush  
With exceptional 43" reach.  
*Replacement brush also available separately.*  
**Order No. LTB512**



(1) Vacuum Adapter  
Connects to shop vac or blower to remove the lint while rotary brushing.



(1) Blockage Removal Tool  
Removes heavy blockages and cleans gutter downspouts.



(1) Dryer Adapter  
If you don't have a shop vac or blower, use the dryer air to remove the lint while rotary brushing.

# LintEater

## 9-Piece Rotary Dryer Vent Cleaning System



Makes multiple turns in dryer vents



Easy to use with your cordless drill  
*Please note: drill recommended - not included*

Linteater DVD Demo  
**Order No. DVDEMO**

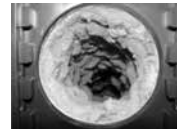

Before



After

## Order No. RJR601

- 4 piece Dryer Vent Cleaner
- Removes lint build-up
  - Effectively cleans all types of dryer vents (metal, foil, while vinyl)

### LintEater Jr

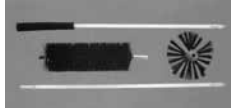

Kit includes:  
(1) 18" flexible rod with removable handle  
(1) 18" extension rod  
(1) Large 2-1/2" dia. lint trap brush  
(1) 4" dia. dryer vent brush



## Order No. LC101

- Lint Catcher
- Captures loosened dirt from the dryer vent while rotary brushing
  - Works great when cleaning from the outside or inside

**LintEater** Accessory



## Order No. B68C

- Vent Cleaning Brush
- 10 ft. long
  - Nylon bristles, 4" dia.



## Order No. B81C

- Vent Cleaning Brush
- 32" long
  - Nylon bristles, 4" dia.



## Order No. 6057

- Lint Lizard  
Dryer Lint Vacuum Attachment
- Attaches to almost any vacuum hose
  - 43" clear hose

**NEW!**



# DRYER PARTS

## Order No. QBVC

### Dryer Vent Check

- Low cost device for checking dryer vent systems
- Quickly and easily determine if dryer vent is clear or restricted
- Put one strip in the dryer and one at the end of the vent, color indicates clog

Two strips per package  
One for dryer/one for vent  
Red = okay White = clog

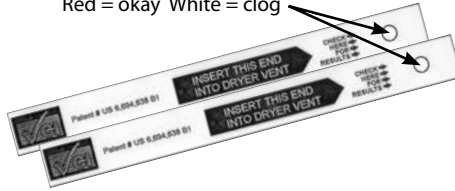

**Order No. QBVCDIS**  
24 piece display

## Periscope Kits

Ideal for tight venting areas - Four sizes to fit most applications!

General Periscope Specifications:

- 2" x 6" rigid metal construction
- (1) 4" male snap-lock fitting
- (1) 4" collar for dryer connection
- Sections on the 18-29" and 29-50" can be reversed for airflow the same or apart



### Order No. 110175 (05PERIR)

retail pkg, 0-5" baffle, qty: 1

### Order No. 110144 (05PERICS)

bulk, no baffle, qty: 9

## 0-5"

- Use where outlets overlap or are very close
- Baffles help direct airflow in 3-18" situations
- Sections are not reversible
- Draw band female collar
- Rotate to fit any position



### Order No. 110133 (1829PERIR)

retail pkg, qty: 1

### Order No. 110114 (1829PERICS)

bulk, qty: 9

## 18-29"

- Reaches side of most dryers
- Two piece assembly
- Beveled ends
- Draw band female collar
- Rotate to fit any position
- Openings can be on the same or opposite side



### Order No. 110128 (018PERIR)

retail pkg, 0-18" baffle, qty: 1

### Order No. 110146 (018PERICS)

bulk, 0-18" baffle, qty: 8

## 0-18"

- Use where outlets overlap or are very close
- Baffles help direct airflow in 3-18" situations
- Sections are not reversible
- Draw band female collar
- Rotate to fit any position



### Order No. 110174 (2950PERIR)

retail pkg, qty: 1

### Order No. 110117 (2950PERICS)

bulk, qty: 4

## 29-50"

- Reaches top of most dryers
- Four-piece assembly
- Beveled ends
- Draw band female collar
- Features swivel cuffs to allow the vent to be directed within 180° from the dryer vent
- Openings can be on the same or opposite side



## Order No. 110497 (VNTLES)

For electric dryers ONLY

### Ventless Lint Trap Kit

- Plastic bucket gets filled with water, dryer air is directed into water, which catches the lint as the hot air is released through the vents in the top of the bucket.
- Kit contains: plastic bucket, 5 foot DV220 flexible pipe, (2) 4" steel clamps

We recommend that you vent dryer to the outside if at all possible



## Order No. 110698 (DRYRBX)

### Space-saving Dryer Outlet Box

- One self-trimming unit
- 17" W x 24" H
- Fits all 16" centers 2x4's & 2x6's
- In-wall (prior to drywall) or retro-fit
- 4 prescored, true 4" dia. knockouts in most common positions
- Meets UL® standard 94HB test for flammability





# DRYER PARTS

**Order No. 110074 (2PKCLMP)**  
**Order No. 110071 (CLMP)**

retail pkg, qty: 2  
 bulk, qty: 1

- 4" Steel Screw Clamps
- Designed to resist stretching
- 1-1/2" Phillips/hex head steel screw
- 4" Minimum I.D. 3.90" max 4-1/4"
- 2 clamps per bag



**Order No. 110103 (EXTCOLR)**

- Snap-Lock Extension Collar
- Designed to extend a wall pipe which does not extend even past the wall
- Used most often in combination with wall offset elbow
- 4" dia. x 3" aluminum collar
- Snap-lock fittings



**Order No. 110642 (DVO30)**

- 2' Heavy Duty Rigid Pipe
- 26 gauge
- One crimped end - one plain end
- Ships nested and requires snap-together assembly
- 4" dia. x 2' long



**Order No. 110139 (EVEVNT)**

- Dryer Eave Vent
- 4" female Snap-Lock™ fitting
- Back draft flapper; no screen per IBC building codes
- Installs flush with eave



**Order No. 010524 (ALHD)**

- 4" Wide Mouth Aluminum Hood
- 11-1/2" tailpipe
- Back-draft flapper
- Back plate
- Fully assembled, riveted tailpipe



**Order No. 110885 (PGHD)**

- 4" Standard, Paintable Galvanized Hood
- 11-1/2" tailpipe
- Back-draft flapper
- Back plate
- Fully assembled
- Ships gray - ready to paint

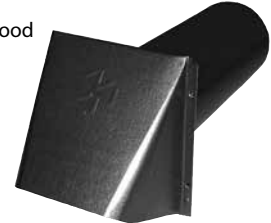

**Order No. 010296 (WMHWDW)**  
**Order No. 110284 (WMHDB)**

bulk white, qty: 1  
 bulk brown, qty: 1

- 4" Wide Mouth Plastic Hood
- 10-1/2" tailpipe
- Back-draft flapper
- Back plate
- Fully assembled, riveted tailpipe



**Order No. 010298 (LVRHDW)**  
**Order No. 110283 (LVRHDB)**

bulk white, qty: 1  
 bulk brown, qty: 1

- 4" Louvered Plastic Hood
- 10-1/2" tailpipe
- Back-draft flapper
- Aluminum trim plate
- Fully assembled, riveted tailpipe
- Faceplate has 4 louvers

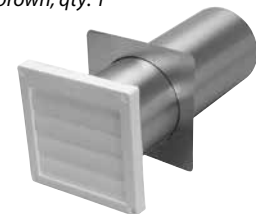

**Order No. 110544 (QB490AL)**

- Adjustable Dryer Vent Elbow
- Turns 90° within 6"
- One crimped end
- 4-piece section adjustability
- 26 Gauge aluminum elbow
- For use with 110642 pipe



**Order No. 110161 (CSL490R)**  
**Order No. 110108 (CSL490)**

retail pkg, qty: 1  
 bulk, qty: 1

- 4" Snap-Lock™ Dryer Vent Elbow
- Turns 90° within 4"
- One male and one female rotating Snap-Lock™ fitting
- Works best with 110120 Snap-Lock™ flexible pipe



retail pkg #110161



# DRYER PARTS

**Order No. 110165 (D490R)**  
**Order No. 110110 (D490)**

retail pkg, qty: 1  
bulk, qty: 1

- 4" Snap-Lock™ Dryer Vent Elbow
- Turns 90° within 4"
- One male and one female rotating Snap-Lock™ fitting
- Can also be used where wall outlet pipe protrudes & is too large for wall offset elbow



**Order No. 110120 (DV830)**

- 8' Snap-Lock™ Flexible Pipe
- 4" aluminum Snap-Lock™ fittings
- Compressed
- One slotted female fitting and one crimped male fitting which Snap-Lock™ together without the need for clamps

Crimped  
end of  
pipe

Slotted end of pipe

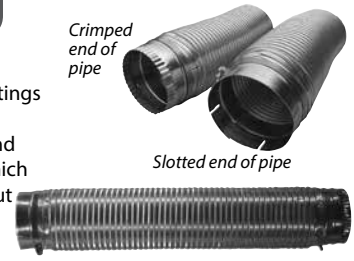

**Order No. 110131 (DV430KT)**  
**Order No. 110091 (DV430)**

retail pkg, qty: 1  
bulk, qty: 1

- 8' Soft End Flexible Readi-Pipe
- 4" aluminum soft cuff on both ends
- It is a kit which includes a 4" x 8 foot flexible pipe and two steel clamps in a display bag

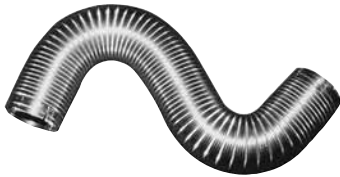

**Order No. 110087 (DV230)**

- 8' Heavy Duty Flexible Pipe
- Two plain, untreaded ends
- Light weight aluminum



**Order No. 110222 (25FTFD)**  
**Order No. 110216 (50FTFD)**

bulk, 25' boxed  
bulk, 50' boxed

- Flexible Foil Duct
- Exceeds UL® 181, Class 1 air connector label
- Multiple design of metallic polyester
- Steel wire support
- Ideal for bathroom fan venting and other general venting
- Manufacturer assumes no responsibility for failure due to improper installation
- Please check your installations instructions and your local building codes for proper use.



Please note: ERP and Dryer manufacturers do not recommend vinyl poly venting or any venting containing plastic. Use of foil venting is also discouraged.

**Order No. 110660 5 foot**  
**Order No. 110661 8 foot**

- Foil Dryer Vent Duct
- Includes two steel clamps
- Ideal for bathroom fan venting and other general venting
- Manufacturer assumes no responsibility for failure due to improper installation
- Please check your installations instructions and your local building codes for proper use.



**Order No. 03063**

- Dryer Cord
- 6 foot, 3 wire, gray
- 50 amps/250 volt, 12,500 watts
- 3 closed ring end connectors
- Strain relief included
- #6/2 - 8/2 Gauge wire
- UL listed

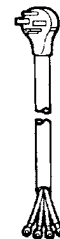
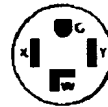

**Order No. 03091**

- Dryer Cord
- 4 foot, 4 wire, black
- 50 amps/250 volt, 12,500 watts
- 4 closed ring end connectors
- Strain relief included
- #6/2 - 8/2 Gauge wire
- UL listed

# WASHER BELTS

ERP offers a broad range of Washing Machine Belts for all major OEMs. Our belts are quality engineered and tested to manufacturer standards.

## BELT PROFILES

**BAREBACK**

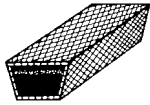

**COGGED**

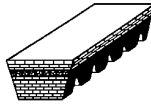

**FLAT**

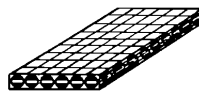

**LAMINATED**

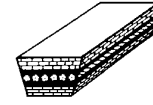

**MULTI-V**

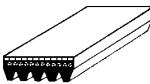

**NOTCHED**

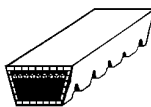

**ROUND**

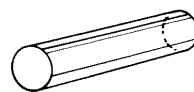

**WRAPPED**

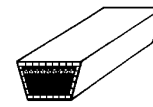

## BELT SPECIFICATIONS

OEM	ERP #	Reference #	Belt Type
<b>Bosch</b>	ER439490		Multi-V <b>NEW!</b>
	ER491680		Multi-V <b>NEW!</b>
<b>Electrolux</b>	ER131686100	LB157	Wrapped
	ER134051000	LB295	Multi-V
	ER134051003		Multi-V <b>NEW!</b>
	ER5300622451	LB155	Bareback
	ER5303261151	LB150	Wrapped
	ER5303261153	LB154	Bareback
	ER5303280326	LB113	Bareback
	ER5308001832	LB153	Bareback
	<b>GE</b>	ERWH1X2026	LB120
ERWH1X2788			Wrapped
ERWH01X10302			Multi-V <b>NEW!</b>
<b>Whirlpool</b>	ER12001788	LB294	Wrapped
	ER211124	LB125	Wrapped
	ER211125	LB126	Bareback
	ER21352320	LB132	Wrapped
	ER22003483	LB297	Bareback

OEM	ERP #	Reference #	Belt Type
<b>Whirlpool</b>	ER27001006	LB302	Bareback
	ER27001007	LB302	Bareback
	ER27155	LB140	Cogged
	ER28808	LB142	Bareback
	ER34001411		Multi-V <b>NEW!</b>
	ER35-0425	LB131	Wrapped
	ER3934700	LB174	Wrapped
	ER8182450		Multi-V <b>NEW!</b>
	ER8540101		Multi-V <b>NEW!</b>
	ER8562613	LB299	Multi-V
	ER902115	LB233	Round (for dishwashers)
	ER95405	LB95405, LB160	Notched
	ERW10006384		Multi-V <b>NEW!</b>
	ERW10388414		Multi-V <b>NEW!</b>
	ERW10388418		Multi-V <b>NEW!</b>

# WASHER PARTS

## BOSCH

Order No. ER422244

Water Valve

**NEW!**



Order No. ER422245

Water Valve

**NEW!**



## ELECTROLUX

Order No. ER131689400

Washer Knob  
White, 1-3/8" diameter  
1-1/4" ext. shaft - 6 o'clock flat

**NEW!**



Order No. ER134042700

Washer Knob  
White, 1-3/8" diameter  
1-1/4" ext. shaft - 6 o'clock flat

**NEW!**



Order No. ER134101800

Lid Lock

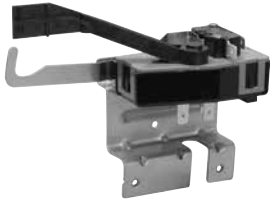

Order No. ER5303279394

Seal Kit

**NEW!**



Order No. ER5308002385

Snubber

**NEW!**



## LG

Order No. ER5220FR2006H

Washer  
Water Valve



Order No. ER5220FR2008F

Washer  
Water Valve

**NEW!**



Order No. ER5221ER1003A

Washer  
Water Valve

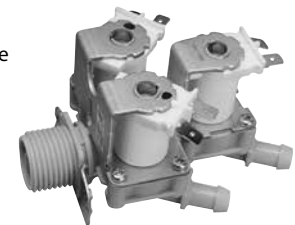

# WASHER PARTS

## GENERAL ELECTRIC

### Order No. ERWH1X484

Foot Pad  
1-1/4" pad for leveling leg.



Also fits: #LP933

### Order No. ERWH1X1944

Spline Drive  
Agitate spline for domestic & commercial washers. Fits models from 1961 to present.



Also fits: #LP301

### Order No. ERWH1X2708

Knob  
Almond  
1-7/8" diameter



### Order No. ERWH1X2721

Timer Knob  
White plastic  
1-3/4" diameter



### Order No. ERWH1X2754

Knob  
White  
1-7/8" diameter



### Order No. ERWH1X2760

Knob  
Chrome plated, 1-1/2" diameter



### Order No. ERWH01X10060

Washer Knob  
White, 1-7/8" diameter  
1/4" ext. shaft - 3 o'clock flat

**NEW!**



### Order No. ERWH01X10310

Washer Knob  
White, 2" diameter  
1/2" ext. shaft

**NEW!**



### Order No. ERWH1X2727

Bungee Cord  
Tub support for newer GE washers.



### Order No. ERWH02X10032

Tub Seal



# WASHER PARTS

## GENERAL ELECTRIC

Order No. ERWH5X256

Clutch Assembly  
Includes retaining clip



Order No. ERWH8X246

Boot  
Molded rubber boot for models built from 1961 to 1995.  
NLA from GE



Also fits: #LP510

Order No. ERWH8X281

Lower Shaft Seal  
Lower transmission seal for models 1957 to 1995.



Also fits: #LP604

Order No. ERWH8X291K

Top Shaft Seal w/Agitate Support  
Seal kit contains ERWH8X291 & WH1X1986.



Also fits: #LP603

Order No. ERWH8X305

Seal  
Outer tub top gasket for models built 1972 to 1995



Also fits: #LP656

Order No. ERWH12X494

Lid Switch  
NLA from GE

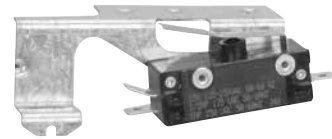

Also fits: #LP211

Order No. ERWH12X10065

Pressure Switch



Order No. ERWH16X513

Clip for SSD-6 & 8GE



Order No. ERWH23X42

Washer Pump



Also fits: #LP112

Order No. ERWH43X102

Agitator

**NEW!**



# WASHER PARTS

## GENERAL ELECTRIC

Order No. ERWH13X10024

Water Valve



Order No. ERWH13X10025

Water Valve

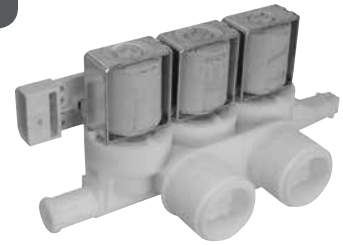

Order No. ERWH13X10026

Water Valve

**NEW!**

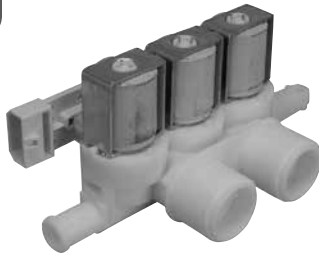

Order No. ERWH13X10027

Water Valve

**NEW!**



Order No. ERWH12X1037

Washer Timer



Order No. ERWH12X10338

Order No. ERWH12X10348

Order No. ERWH12X10350

Washer Timers

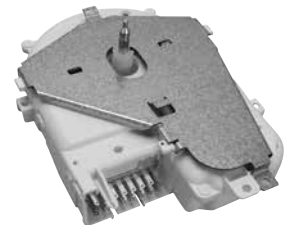

Order No. ERWH12X1000

Order No. ERWH12X1015

Order No. ERWH12X1021

Order No. ERWH12X1022

Order No. ERWH12X1024

Order No. ERWH12X1026

Order No. ERWH12X1030

Order No. ERWH12X1031

Order No. ERWH12X1034

Order No. ERWH12X10071

Washer Timers

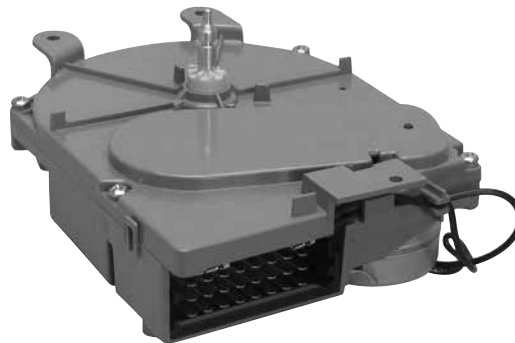

LAUNDRY



# WASHER PARTS

## WHIRLPOOL

Order No. ER21001906

Pump



Replaces Whirlpool #35-6465

Order No. ER21002240

Pump



Replaces Whirlpool #35-6780

Order No. ER280187

Pump



Replaces Whirlpool #280187

Order No. ER285317

Pump  
NLA from Whirlpool

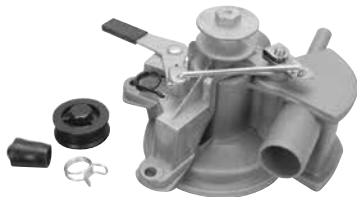

Also fits: #LP115

Order No. ER34001320

Drain Pump



Order No. ER350365

Pump



Also fits: #LP113

Order No. ER3363394

Pump



Also fits: #LP116

Order No. ER3363892

Pump



Also fits: #LP121

Order No. ERW10536347

Pump

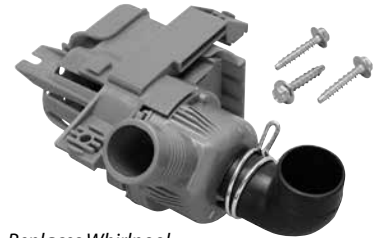

Replaces Whirlpool  
#W10217134, #W10536347

Order No. ER206638K

Siphon Break



Also fits: #LP990

Order No. ER216016K

Elbow with washer  
Drain elbow includes washer



Replaces Whirlpool #W10116738  
Also fits: #LP991

Order No. ER214765

Siphon Break Gasket



# WASHER PARTS

## WHIRLPOOL

Order No. ER2-4660K

Side Mount Injection Fill Assembly (Older Models)

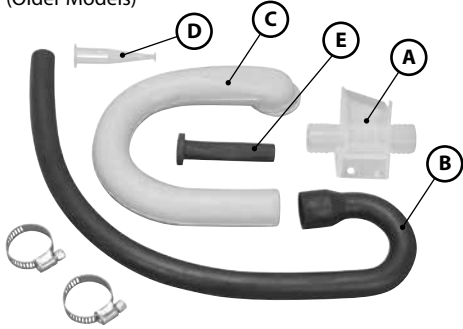

Individual Part Numbers

- |          |                   |                                |
|----------|-------------------|--------------------------------|
| <b>A</b> | <b>ER22213057</b> | <b>Injector Sleeve</b>         |
| <b>B</b> | <b>ER2-13013</b>  | <b>Hose</b>                    |
| <b>C</b> | <b>ER206154</b>   | <b>Injector Tube (LP585)</b>   |
| <b>D</b> | <b>ER213015</b>   | <b>Injector Nozzle (LP580)</b> |
| <b>E</b> | <b>ER216201</b>   | <b>Injector Valve (LP581)</b>  |

Order No. ER2-6680K

Bottom Mount Injection Fill Assembly (Later Models)

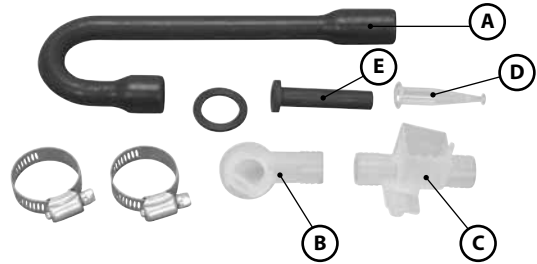

Individual Part Numbers

- |          |                  |                                |
|----------|------------------|--------------------------------|
| <b>A</b> | <b>ER2-15234</b> | <b>Hose</b>                    |
| <b>B</b> | <b>ER2-15235</b> | <b>Injector Tube (LP668)</b>   |
| <b>C</b> | <b>ER2-15447</b> | <b>Injector Sleeve</b>         |
| <b>D</b> | <b>ER213015</b>  | <b>Injector Nozzle (LP580)</b> |
| <b>E</b> | <b>ER216201</b>  | <b>Injector Valve (LP581)</b>  |

Order No. ER2-12989

Hose



Replaces Whirlpool #Y212989  
Also fits: #LP956

Order No. ER3348552

Pump Hose  
Tub hose for direct drive washers.



Order No. ER12001677

Injector Valve Nozzle



**NEW!**

Order No. ER285748

Agitate Cam/Dogs  
Extra long 3-1/2" cam body.



Also fits: #LP254

Order No. ER285811

Agitate Cam Kit



Order No. ER285206

Agitate Cam & Follower Assembly



Also fits: #LP988

LAUNDRY

# WASHER PARTS

## WHIRLPOOL

**Order No. EROA4298K**

Shaft Seal  
Agitator drive shaft seal for wringer and automatic washers



Also fits: #LP348

**Order No. ER80040 (4 pack)**

**Order No. ER80040D (12 pack)**

Agitate Dogs



**Order No. ER91939**

Agitator Shaft Seal



Also fits: #LP632

**Order No. ER204013**

Spin Bearing Assembly  
Rubber mounted bearing found on helical drive washers



Replaces Whirlpool #6-2040130  
Also fits: #LP341

**Order No. ER359449**

Lower Spin Tube Seal



Also fits: #LP634

**Order No. ER356934**

Upper Center Post Seal



Replaces Whirlpool #8577376  
Also fits: #LP630

**Order No. ER383727**

Tub Grommet  
Tub seal for belt drive models



Also fits: #LP633, #966901

**Order No. ER93553**

Grommet  
Tub grommet for belt drive washers



Also fits: #LP598

**Order No. ER3968381**

Outer Tub Center Seal



**Order No. ER285753**

Drive Coupler  
Newer style for direct drive washers

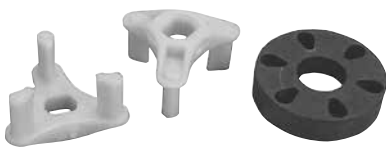

Also fits: #LP337

**Order No. ER285753A**

Drive Coupler  
Has metal inserts

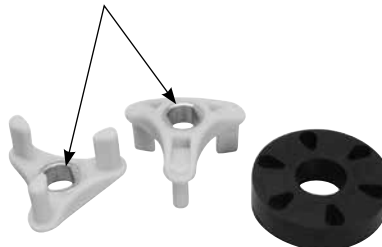

**Order No. ER285852**

Heavy Duty Coupler  
Has metal stabilizer



# WASHER PARTS

## WHIRLPOOL

Order No. ER205000

Motor Spring & Glide Kit  
Rebuilds motor roller assembly on most automatic washers.

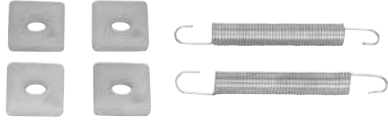

Also fits: LP921

Order No. ER211124/25K

Belt & Roller Kit

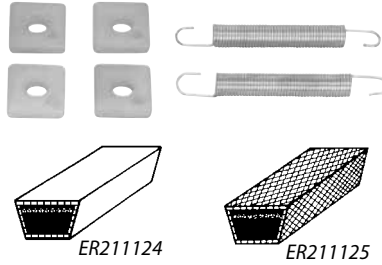

Order No. ER285744

Washer Pad



Order No. ER64208

Spin Tube



Order No. ER285671

Lid Switch  
Round pin terminals

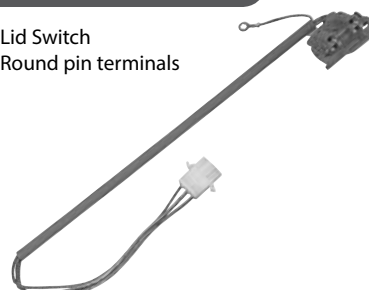

Also fits: ES671

Order No. ER3949238

Lid Switch

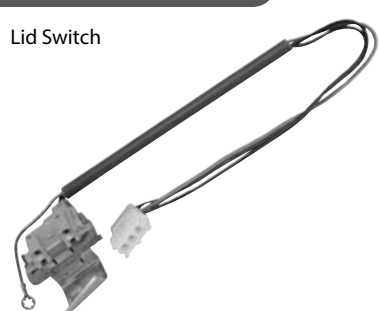

Order No. ER3949247

Lid Switch  
Flat pin terminals

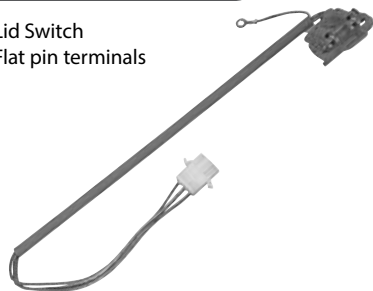

Also fits: ES247

Order No. ER8318084

Lid Switch



Order No. ER279347

Lid Switch & Actuator  
Used on some dryers also

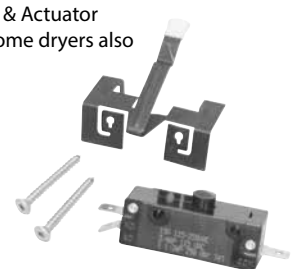

Also fits: LP210

Order No. ER285785

Clutch Assembly



Order No. ER49621

Leveling Leg



Order No. ERW10001130

Leveling Leg



# WASHER PARTS

## WHIRLPOOL

Order No. ER22004073  
Order No. ER22004189  
Order No. ER22004323

Washer Timers

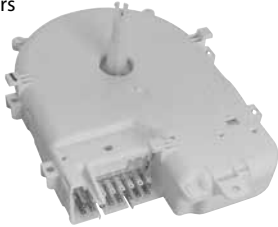

Order No. ER22004380

Washer Timer

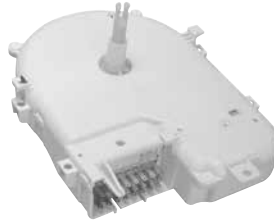

Order No. ER285792

Basket Drive



Order No. ER34001269

Drum Motor

**NEW!**



Order No. ER285587

Washer

**NEW!**



Order No. ER285790

Liner Kit

**NEW!**



Order No. ER34001324

Sensor

**NEW!**



Order No. ER205613

Water Valve

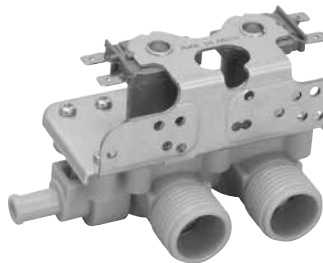

Order No. ER8181694

Water Valve

**NEW!**



Order No. ER8182862

Water Valve

**NEW!**



Order No. ER3362624

Timer Knob



Order No. ER3364290

Timer Knob



# WASHER PARTS

## WHIRLPOOL

Order No. ER3364291

Timer Knob



Order No. ER3956905

Timer Knob

**NEW!**



Order No. ER3957749

Knob  
2-3/4" diameter



Order No. ERW10180213

Timer Knob

**NEW!**



Order No. ERW10180214

Knob Skirt

**NEW!**



Order No. ERW10180218

Control Knob

**NEW!**



Order No. ER34001302

Boot

**NEW!**



Order No. ER285134

Bearing

**NEW!**



Order No. ER8181846

Handle



Order No. ER85114

Foot Pad  
1-1/8" diameter pad  
for leveling leg  
*NLA from Whirlpool*



*Also fits: LP932*

Order No. ER93770

Grey Lid Bumper



*Also fits: LP617*

Order No. ERW10072840

O-Ring

**NEW!**





# WASHER HOSES

## DRAIN HOSES

Order No. ERB150

15/16" x 50 ft.



Order No. ERSSD6

1" x 6 ft.

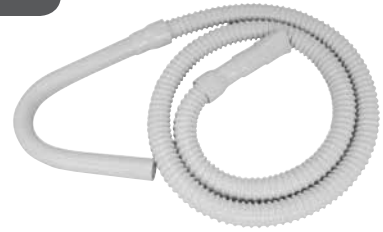

Order No. ERSSD6GE

SSD Hose with GE Male Connection  
6 ft.

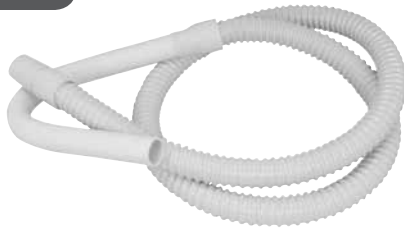

Order No. ERSSD6PF

Poly-Flo Hose  
Has molded adapter to fit 1", 1-1/8" and 1-1/4" outlets.  
Adjustable plastic gooseneck allows hose length to be shortened to any length while keeping a perfect "U" for the hose outlet.

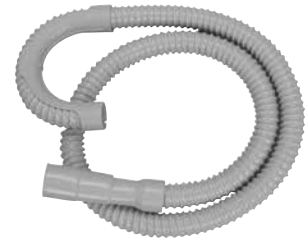

Order No. ERSSD8

1" x 8 ft.



Order No. ERSSD8GE

SSD Hose with GE Male Connection  
8 ft.

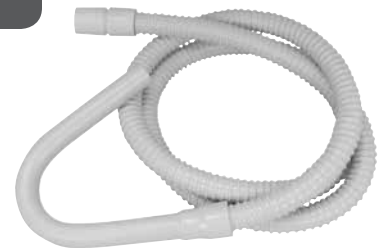

Order No. ERSSD50

Bulk Poly flow SSD drain hose  
1" x 50 ft.

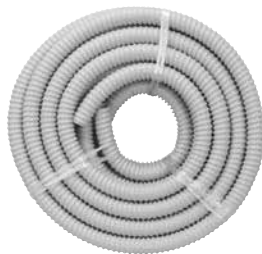

Order No. WDH6FT 6 foot  
Order No. WDH8FT 8 foot

Washer Drain Hose  
• Corrugated plastic hose fits 1", 1-1/8", 1-1/4" & 1-3/8" outlets for Whirlpool, Kenmore, GE, Frigidaire & most other brands  
• Bend & stay feature creates the hook end  
• Crush resistant, non-kinking, flexible  
• Manufactured to OEM specifications



Order No. ERGNB

Gooseneck



Order No. ERHM101

Hose Mender

**NEW!**



Order No. ERLA185

CUFA Connector End



# WASHER HOSES

## FILL HOSES

High quality Jason fill hoses give performance for a low price.

	ERP #	Description	Case Qty.
A	ER3804FE	4 ft. Female x Female 90°	25
A	ER3805FE	5 ft. Female x Female 90°	25
A	ER3806FE	6 ft. Female x Female 90°	20
A	ER3808FE	8 ft. Female x Female 90°	20
B	ER3804FF	4 ft. Female x Female	25
B	ER3805FF	5 ft. Female x Female	25
B	ER3806FF	6 ft. Female x Female	20
B	ER3808FF	8 ft. Female x Female	20
B	ER3810FF	10 ft. Female x Female	20
B	ER3812FF	12 ft. Female x Female	20
B	ER3815FF	15 ft. Female x Female	20
C	ER3804MF	4 ft. Male x Female	25
C	ER3806MF	6 ft. Male x Female	20
D	ERHP403	"Y" mixer hose, single male end with two female couplings	25

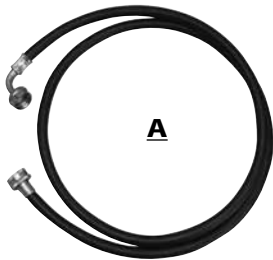

**A**

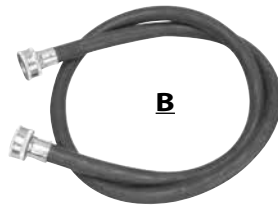

**B**



**C**

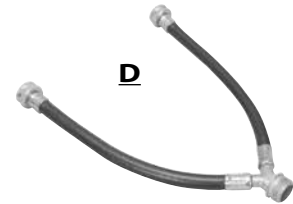

**D**

### Order No. ERRW79SC

Hose Washer with screen  
Sold in 25 pack



### Order No. ERRW79

Washers  
Sold in 100 pack



### Order No. ERLA104

Clamp  
1/4" - 5/8"



# LAUNDRY MISCELLANEOUS

Order No. ER343

Universal Style Washer Water Valve



Order No. ER525

Universal Style Washer Water Valve



Order No. ERWV-1

Universal Style Washer Water Valve

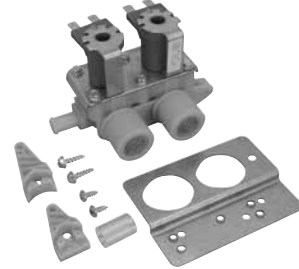

Order No. ER16300

Washer Switch

**NEW!**



Order No. ER16301

Washer Switch

**NEW!**



Order No. ER800468P

Washer Pressure Switch

**NEW!**



Replacement for Speedqueen

Order No. ERDC47-00019A

Dryer Element

**NEW!**

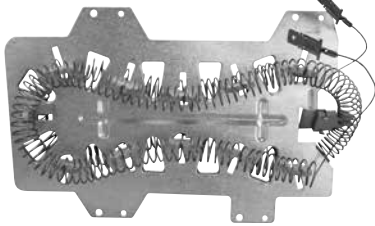

Replaces Samsung #DC47-00019A

Order No. B241C

Lint Catcher Brush

- Great for dryers with lint trap on top or front
- 30" long



Order No. B295C

Lint Catcher Brush

- Great for dryers with lint trap on lower level
- 20" long, bendable

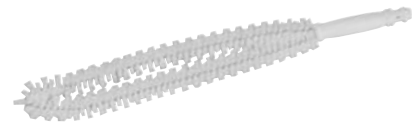

Order No. B304C

Dryer Lint Screen Brush

**NEW!**



Order No. B68C

Dryer Vent Duct Cleaning Brush

- Removes lint from dryer vent duct
- Reduces fire hazards
- Reduces electric consumption
- 10 feet long
- Nylon bristles - 4" dia.
- Made in USA



Order No. B81C

Mini Dryer Vent Duct Cleaning Brush

- Removes lint from dryer vent duct
- Reduces fire hazards, electric consumption
- 32" long, nylon bristles 4" dia.
- Made in USA



# LAUNDRY MISCELLANEOUS

## Order No. 875G

Hose Clamp Pliers  
For single wire spring clamps



## Order No. THP-1 8-3/4" long

Hoseplier  
• Sure grip hosepliers tightens & loosens hoses quickly & easily  
• Great for washer with indented water valves  
• Designed by a technician for a technician



## Order No. KP-2

Klamplier  
• Service tool for double ring wire clamps used on washers & dishwashers  
• Plier locks clamp in jaw  
• Designed by a technician for a technician

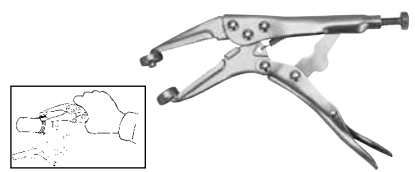

## Order No. APPL-CVR

Washer/Dryer Cover  
• Keeps washer & dryer looking like new  
• Fits all standard washers & dryers  
• Heavy duty canvas  
• Water repellent & mildew resistant  
• Back is open for water, electrical & gas connections



## Order No. ERTB123A

Tub Nut Wrench  
Removes tub nut from Maytag, GE and Whirlpool washing machines



## Order No. ERVA

Vibration Pads (4 pack)  
• Made from recycled tire rubber  
• Shock absorption pad used to reduce sound, vibration & pulsating of dryers or washing machines

**NEW!**



## Order No. ALLE-04

Dryer Motor Clamp Release Tool (the Allenbar)  
• Designed to remove retainer clips from dryer motors  
• Eliminates damage to appliances and your knuckles  
• Fits almost any dryer motor retainer clip



## Order No. WM0612N 6 pk

Washer Magic  
• Safely & effectively removes lime scale, soap scum & iron stains  
• Extends life of washing machine  
• Safe for plumbing & septic systems  
• Works on all washers including high efficiency

**NEW PART NUMBER**



## Order No. OM112 (Aluminum) Order No. OM212 (Fabric)

Lint Snare  
• Stops lint from clogging laundry tub or sink  
• Two per pack, two nylon clamps  
• Made in USA



## Order No. PHG1

Hose Grip  
• Clamps onto stand pipe  
• Reduces chance of flooding caused by water pressure ejecting drain hose from stand pipe  
• Fits 1-1/2" or 2" stand pipe through 1" to 1-7/16" washer hose



## Order No. WB06T 1lb. 14 oz.

Yellow Out® Laundry Whitener  
• Removes rust, yellowing and dinginess from white, washable fabrics & laundry  
• Takes out most color runs & dye stains  
• Safer than bleach



LAUNDRY

# ICE MAKERS

All ERP ice makers are 100% tested.

**Order No. ER4317943**

Ice Maker

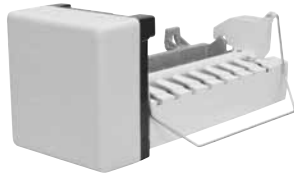

Replaces: Whirlpool #4317943, Supco #RIM943

Replaces existing ice maker only

**Order No. ER4317943L**

Ice Maker

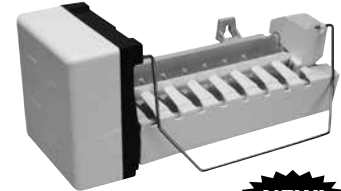

Replaces: Whirlpool #4317943, Supco #RIM943

**NEW!**

**Order No. ER2198597**

Replaces Whirlpool #2198597

Ice Maker  
For 25 - 27 cubic foot side by sides  
with ice bin in door

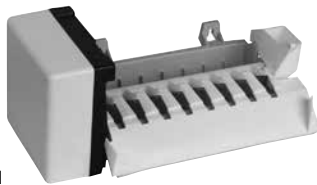

**Order No. ER2198597RK**

Ice Maker Repair Kit  
Includes ER4389102 ice maker board

**Order No. ER5303918277**

Ice Maker

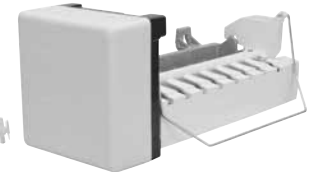

Replaces Frigidaire #5303918277

Replaces existing ice maker only

**Order No. ER5303918344**

Ice Maker

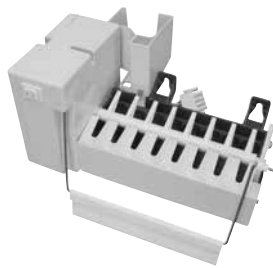

Replaces existing ice maker only  
Replaces Frigidaire #5303918344

**Order No. ERGEIM**

Ice Maker



Replaces GE #IM-1, #IM-3, Supco #RIM300

Replaces existing ice maker only

**Order No. ERWIM**

Ice Maker

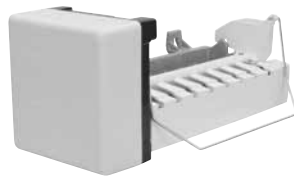

Replaces Whirlpool #D7824706Q, #4317943, Supco #RIM900

Replaces existing ice maker only

**Order No. ERWR30X10093**

Ice Maker



Replaces GE #WR30X10093

**Order No. ERW10190961**

Ice Maker



**NEW!**

**Order No. ERW10190961RK**

Ice Maker



**NEW!**



# ICE MAKERS

All ERP ice makers are 100% tested.

**Order No. ER4389102**

Ice Maker Board

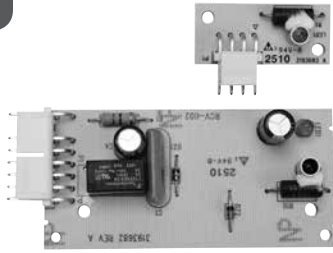

Replaces Whirlpool #4389102

**Order No. ERFWH**

Wiring Harness  
Add this wiring harness to ERWIM and replace Frigidaire #5303918277 or Supco #RIM116



**Order No. ERWWHF**

Wiring Harness  
Flat Whirlpool ice maker wiring harness



**Order No. ERWWHR**

Wiring Harness  
Round Whirlpool ice maker wiring harness



**Order No. ERD7813010**

Wiring Harness



Replaces Whirlpool #D7813010

**Order No. ER628366**

Gear & Motor Assembly  
ERP direct replacement for popular electronic style Whirlpool ice makers.



Replaces Whirlpool #628366, #W10190935

BACK

FRONT

**Order No. ER627985**

Thermostat



Replaces Whirlpool #627985, Supco #SL7985

**Order No. ER2217220**

Ice Maker Pump

**NEW!**



Replaces GE #WR57X10028, Whirlpool #2217220

**Order No. ER241685703**

Ice Maker Actuator

**NEW!**



Replaces Electrolux #241685703

**Order No. ER241675701**

Ice Maker Solenoid

**NEW!**



Replaces Electrolux #241675701

**Order No. ERWR62X10055**

Ice Maker Solenoid

**NEW!**



Replaces GE #WR62X10055

REFRIGERATION



# ICE MAKERS

Order No. ER241734302

Water Valve



Replacement for Electrolux

Order No. ER241803701

Water Valve

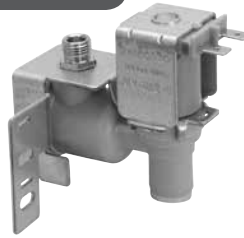

Replacement for Electrolux

Order No. ERWR57X77

Water Valve

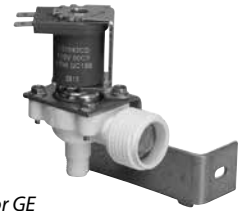

Replacement for GE

Order No. ERWR57X88

Water Valve

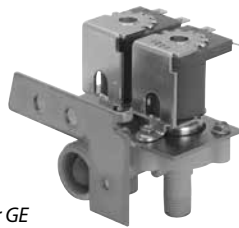

Replacement for GE

Order No. ERWR57X10032

Water Valve



Replacement for GE

Order No. ERWR57X10033

Water Valve

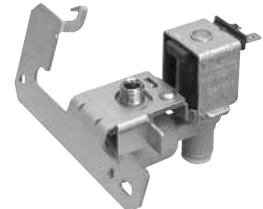

Replacement for GE

Order No. ERWR57X10051

Water Valve

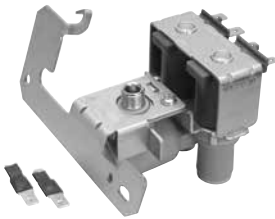

Replacement for GE

Order No. ERWR57X10082

Water Valve

**NEW!**

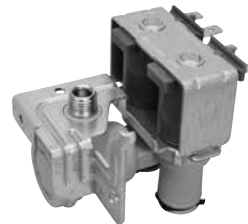

Replacement for GE

Order No. ERDA62-00914A

Water Valve

**NEW!**



Replacement for Samsung

Order No. ERDA62-00914B

Water Valve

**NEW!**

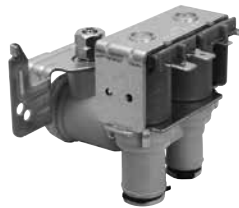

Replacement for Samsung

Order No. ERDA62-01477A

Water Valve

**NEW!**



Replacement for Samsung

Order No. ERDA62-01585A

Water Valve

**NEW!**

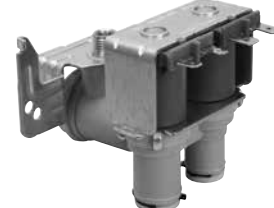

Replacement for Samsung

Order No. ER4318046

Water Valve

**NEW!**

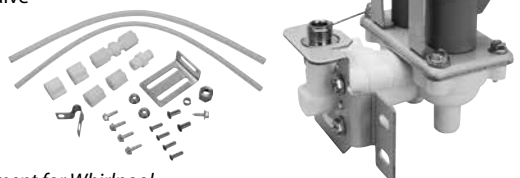

Replacement for Whirlpool

Order No. ER4318047

Water Valve

**NEW!**

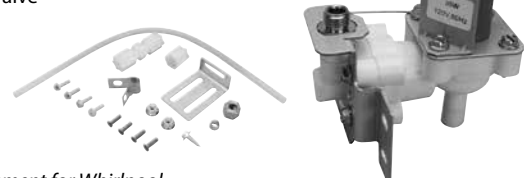

Replacement for Whirlpool

# ICE MAKERS

**Order No. ER56595-3**

Water Valve

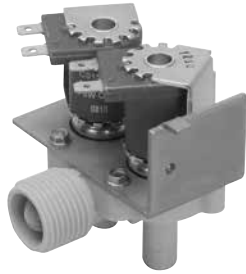

*Replacement for Whirlpool*

**Order No. ER61005273**

Water Valve



*Replacement for Whirlpool*

**Order No. ER61005626**

Water Valve

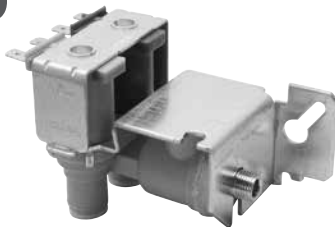

*Replacement for Whirlpool*

**Order No. ER759296**

Water Valve



*Replacement for Whirlpool*

**Order No. ERD7742204**

Water Valve

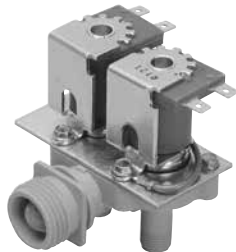

*Replacement for Whirlpool*

**Order No. ERR0175017**

Water Valve

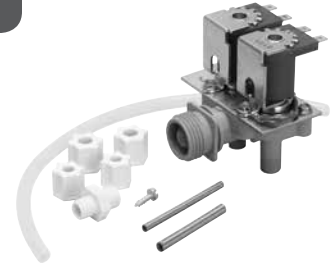

*Replacement for Whirlpool*

**Order No. ERR0175012**

Water Valve



*Replacement for Whirlpool*

**Order No. IMKR2** (2 foot length)

**Order No. IMKR6** (6 foot length)

**Order No. IMKR15** (15 foot length)

**Order No. IMKR25** (25 foot length)

Ice maker PEX Tubing

- One-piece construction - eliminates leaks
- Will not degrade like vinyl
- Not affected by chlorine
- Does not contribute to taste and odor problems
- Sterilized during manufacturing process
- #IMKR2 and #IMKR6 are used for installing water filters behind unit



**Order No. H-316** pint

**Order No. H-301** gallon

Ice Machine Cleaner

- Removes slime and scale build-up
- Restores efficiency
- Fast acting, non-foaming
- Nickel safe - meets Manitowac spec. GES-6 for ice machine cleaners
- All food-grade ingredients



# WATER FILTERS

## Water Filter Estimated Percent Reduction:

- A** Estimated % Reduction: Chlorine, Taste & Odor 95%, Particulates 85%
- B** Estimated % Reduction: Chlorine, Taste & Odor 95%, Lead 95%, Cysts 99%, Turbidity 95%, Asbestos 95%, Atrazine 95%, Alachlor 95%, Lindane 95%, 2,4-D 95%, Mercury 95%, Toxaphene 95%, P-Dichlorobenzene 95%, Benzene 95%

**Order No. ER4204490**

SGF-ZS48 **NEW!**

**B**

Replaces Sub-Zero

**Order No. ER4396508**

SGF-W80 **NEW!**

**B**

Replaces Whirlpool

**Order No. ER4396510**

SGF-W01 **NEW!**

**B**

Replaces Whirlpool

**Order No. ER4396701**

SGF-W10 **NEW!**

**B**

Replaces Whirlpool

**Order No. ER5231JA2006A**

SGF-LA50 **NEW!**

**A**

Replaces LG

**Order No. ER5231JA2006B**

SGF-LB60 **NEW!**

**B**

Replaces LG  
Also fits: FLTR9990

**Order No. ERADQ36006102**

SGF-LA07 **NEW!**

**A**

Replaces LG

**Order No. ERUKF8001**

SGF-M09 **NEW!**

**B**

Replaces Whirlpool

REFRIGERATION

# WATER FILTERS

Order No. ER0060218743



Replaces Haier #00602187431RF-2800-13

Order No. ER5231JA2002A

SGF-LA22

**A**

**NEW!**



Replaces LG  
Also fits: LG #LT500P

Order No. ER8171413

SGF-W31

**A**

**NEW!**



Replaces Whirlpool  
Also fits: Whirlpool #8171414

Order No. ERDA29-00003G

SGF-DSB30

**B**

**NEW!**



Replaces Samsung

Order No. ERMWF

SGF-G9

**B**

**NEW!**



Replaces GE

Order No. ERUKF7003

SGF-M07

**A**

**NEW!**



Replaces Whirlpool

Order No. ERWF1CB

WF1CB-SW

**A**



Replaces Electrolux

Order No. ERWFCB

WFCB-SW

**B**



Replaces Electrolux

Order No. ERWF270

Ice Maker Replacement Filter  
6-3/8" length

**A**



Replaces Supco #WF270

Order No. ERWF271

Ice Maker Replacement Filter  
10" length

**A**



Replaces Supco #WF271, Whirlpool #4392949

# COLD CONTROLS

Order No. ER240383703



Replaces Electrolux #240383703

Order No. ER241586503



Replaces Electrolux #241586503

Order No. ER5303200810



Replaces Electrolux #5303200810

Order No. ER5304404821



Replaces Electrolux #5304404821

Order No. ER5304421067



Replaces Electrolux #5304421067

Order No. ER5304421256



Replaces Electrolux #5304421256

Order No. ER5308015762



Replaces Electrolux #5308015762

Order No. ERWR9X208



Replaces GE #WR9X209  
Robertshaw #3030116  
Supco #GC116

Order No. ERWR9X355



Replaces GE #WR9X355  
Robertshaw #3030140  
Supco #GC140

Order No. ERWR9X405

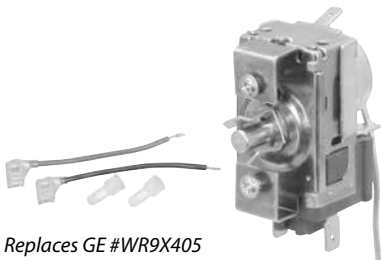

Replaces GE #WR9X405  
Robertshaw #3030305  
Supco #GC175

Order No. ERWR9X411



Replaces GE #WR9X411  
Supco #GC177

Order No. ERWR9X491



Replaces GE #WR9X491,  
#WR9X545 Supco #GC188



# COLD CONTROLS

Order No. ERWR9X499



Replaces GE #WR9X499  
Supco #GC192

Order No. ERWR9X501



Replaces GE #WR9X501  
Supco #GC178

Order No. ERWR9X10043



Replaces GE #WR9X10043

Order No. ERWR9X10074



Replaces GE #WR9X10074

Order No. ER1123394



Replaces  
Whirlpool #1123394  
Supco #GC182

Order No. ER2198202



Replaces Whirlpool #2198202

Order No. ER2325700



**NEW!**

Replaces Whirlpool #2325700

Order No. ER4390587



Replaces Whirlpool #4390587

Order No. ER61005789



Replaces Whirlpool #61005789

Order No. ER819470

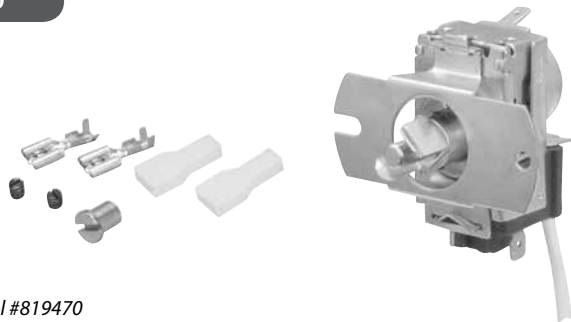

Replaces: Whirlpool #819470  
Supco #GC185

Order No. ER61006072

Cold Control Knob

**NEW!**



REFRIGERATION



# DOOR BARS

**Order No. ER215366002**

White, 30-3/4" x 1-11/16"

**Order No. ER215366074**

White, 26-3/16" x 1-11/16"

**Order No. ER218027022**

White, 23-13/16" x 1-11/16"  
Replacements for Electrolux

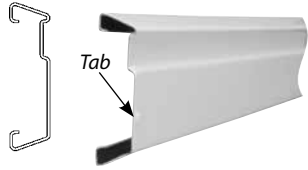

Used with endcaps:  
#ER215267701 (R/L), #ER215473602 (R/L),  
#ER3206150 (R), #ER5303324302 (L),  
#ER5304402687 (R), #ER5304402688 (L)

**Order No. ER240331401**

White, 20-1/4" x 1-3/4"

**Order No. ER240331404**

White, 19-1/8" x 1-3/4"  
NLA from Electrolux

**Order No. ER240331405**

White, 16-3/4" x 1-3/4"  
NLA from Electrolux

**Order No. ER240331407**

White, 9" x 1-3/4"

Replacements for Electrolux

Used with endcaps:

#ER240311502 (R), #ER240311501 (L),  
#ER240331502 (R), #ER240331501 (L)

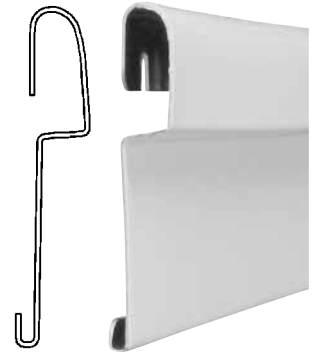

**Order No. ER5303281481**

White, 24-9/16" x 1-5/8"  
Replacement for Electrolux

Used with endcaps:

#ER5303207230 (R), #ER5303207229 (L)

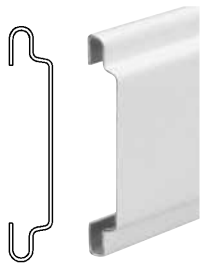

**Order No. ER5303300237**

White, 24" x 1-1/8"  
Replacement for Electrolux

Used with endcaps:

#ER3206165 (R), #ER3206166 (L)

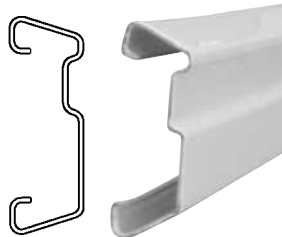

**Order No. ERWR17X3691**

White, 20-3/4" x 2"

**Order No. ERWR17X3880**

White, 21-1/4" x 2"

**Order No. ERWR71X10077**

White, 24-1/2" x 2"

**Order No. ERWR71X10080**

White, 22-5/8" x 2"

**Order No. ERWR71X10081**

White, 21-5/16" x 2"

Replacements for GE

Used with endcaps:

#ERWR2X9144 (R/L), #ERWR2X8345 (R/L)

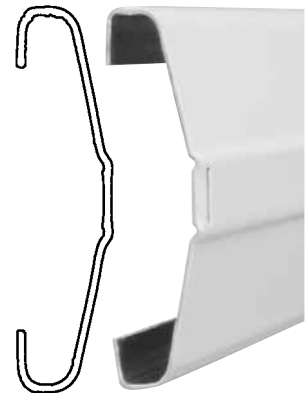

**Order No. ERWR17X2296**

White, 22-7/8" x 1-3/8"

**Order No. ERWR17X3692**

White, 20-9/16" x 1-3/8"

**Order No. ERWR17X3942**

White, 20-5/8" x 1-3/8"  
Replacements for GE

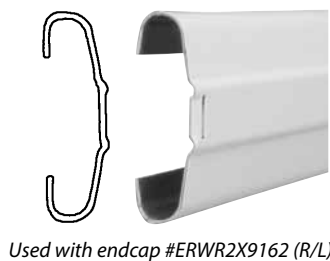

Used with endcap #ERWR2X9162 (R/L)

**Order No. ERWR71X10106**

White, 29-1/8" x 2-1/8"  
Replacement for GE

Used with endcap  
#ERWR2X7975 (R/L)

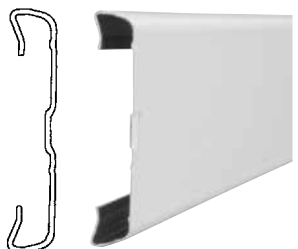

**Order No. ERWR71X10281**

White, 21-9/16" x 2-1/4"

**Order No. ERWR71X10282**

White, 9-3/4" x 2-1/4"

Replacements for GE

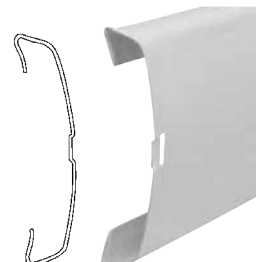

# DOOR BARS

## Order No. ER61001962

White, 20-7/8" x 1-9/16"

## Order No. ER61001965

White, 21" x 1-9/16"

## Order No. ER61002400

White, 23-3/8" x 1-9/16"

Replacements for Whirlpool

These bars have 1 of each cutout on each end

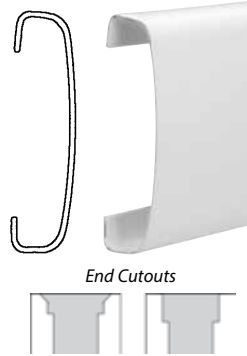

## Order No. ER61001963

White, 20-1/8" x 1-9/16"

## Order No. ER61001964

White, 21-5/8" x 1-9/16"

## Order No. ER61002399

White, 23-3/4" x 1-9/16"

Replacements for Whirlpool

Used with endcap #ER61002112 (R/L)

These bars have 1 of each cutout on each end

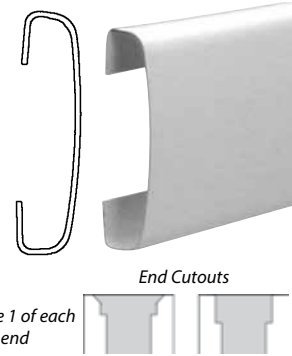

## Order No. ER2163631

White, 21-5/8" x 1"

Replacement for Whirlpool

End Cutout

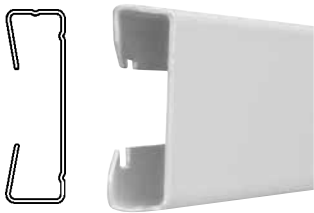

## Order No. ER984177

White, 26-3/8" x 3/4"

Replacement for Whirlpool

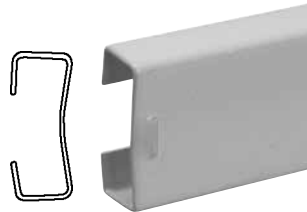

## Order No. ERUDB

Universal Door Bar  
Silver, 25-1/2" x 1-3/8"

Includes endcaps and screws

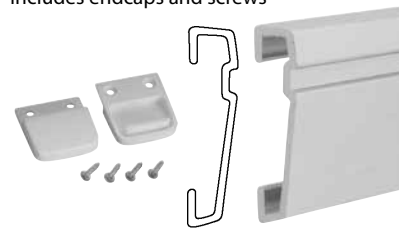

## Order No. ER240331UNIVKIT

Universal Door Bar Kit  
Kit includes door bar and four end caps

**NEW!**

This door bar can be cut down to match many door bars. See the chart to find your part number and where to trim the door bar. Instructions are included to guide you, step by step to match your old door bar.

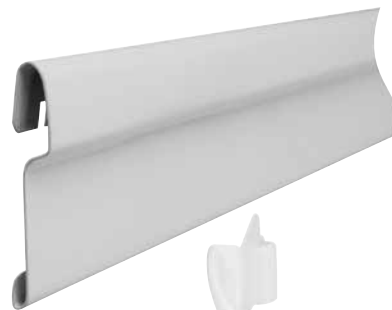

#ER240331501

#ER240331502

## Order No. ER240331UNIV

Universal Door Bar Only  
White, 26-1/8" x 1-3/4"

**NEW!**

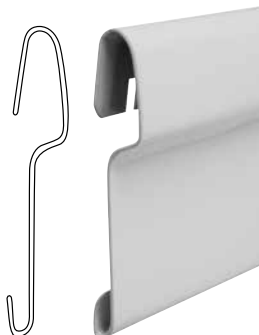

#ER240311501

#ER240311502

Electrolux Part No.	Endcaps Part Numbers Used on Door Bar	Orig. Door Bar Length	Where to cut ER240331UNIV
240534701	240331501(L), 240331502(R)	24-1/8"	20-1/8"
240534801	240311501(L), 240311502(R)	22"	18"
240534901	240311501(L), 240311502(R)	24-1/4"	20-1/4"
240535001	240311501(L), 240311502(R)	20-1/2"	16-1/2"
240535101	240311501(L), 240311502(R)	22-3/4"	18-3/4"
240535201	240331501(L), 240331502(R)	22-5/8"	18-5/8"
240535301	240311501(L), 240311502(R)	13-1/8"	9-1/8"

# BINS/ENDCAPS

Order No. ER240323001

White Refrigerator Bin



Replaces Electrolux #240323001

Order No. ER240323002

Clear Refrigerator Bin

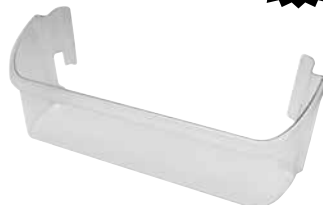

Replaces Electrolux #240323002

Order No. ER2187172

White Refrigerator Bin



Replaces Whirlpool #2187172

Order No. ER530324302

Left

Replacements  
for Electrolux

Order No. ER3206150

Right

Left

Right



FRONT

BACK



FRONT

BACK

Order No. ER3206166

Left

Replacements  
for Electrolux

Order No. ER3206165

Right

Left

Right



FRONT

BACK

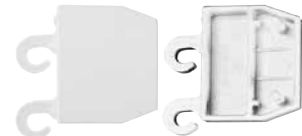

FRONT

BACK

Order No. ER5303207229

Left

Replacements  
for Electrolux

Order No. ER5303207230

Right

Left

Right



FRONT

BACK



FRONT

BACK

Order No. ER5304402688

Left

Replacements  
for Electrolux

Order No. ER5304402687

Right

Left

Right



FRONT

BACK



FRONT

BACK

Order No. ER215473602

Replacement for Electrolux

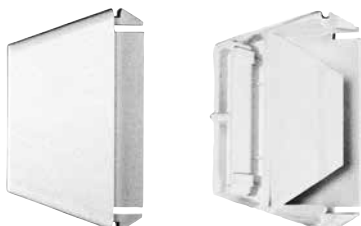

FRONT

BACK

Order No. ER215267701

Replacement for Electrolux



FRONT

BACK

# ENDCAPS

**Order No. ER240311501**

Left, "A" = 4-1/4"

**Order No. ER240311502**

Right, "A" = 4-1/4"

**Order No. ER240331501**

Left, "A" = 5-1/2"

**Order No. ER240331502**

Right, "A" = 5-1/2"

*Replacements for Electrolux*

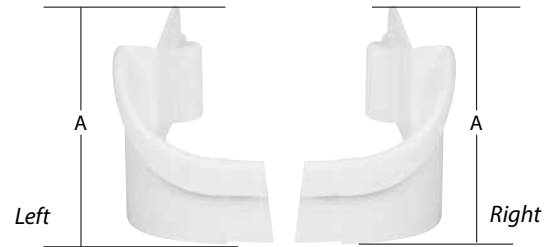

**Order No. ERWR2X7232**

*Replacement for GE*

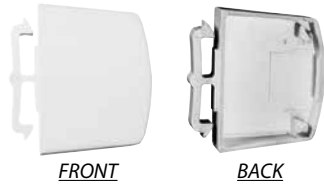

**Order No. ERWR2X7674**

*Replacement for GE*

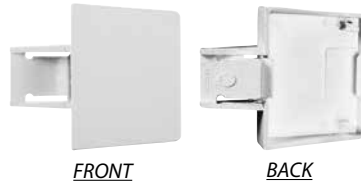

**Order No. ERWR2X7975**

*Replacement for GE*

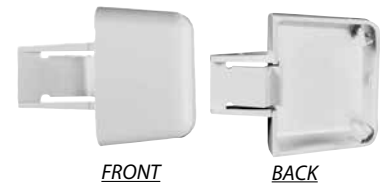

**Order No. ERWR2X8345**

*Replacement for GE*

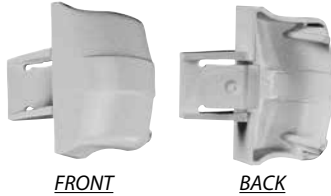

**Order No. ERWR2X9144**

*Replacement for GE*

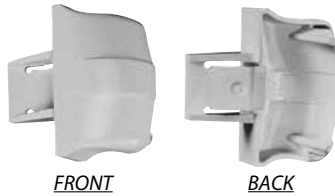

**Order No. ERWR2X9162**

*Replacement for GE*

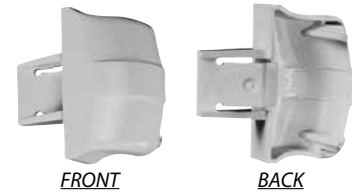

**Order No. ER61002112**

*Replacement for Whirlpool*



**Order No. ER2183139**

Handle endcap  
Plastic  
chrome  
finish  
*Replacement for Whirlpool*



**Order No. ER2183140**

Handle endcap  
Plastic  
black  
finish  
*Replacement for Whirlpool*



**Order No. ER2183141**

Handle endcap  
Plastic  
white  
finish  
*Replacement for Whirlpool*



**Order No. ER2191880**

Handle endcap  
Plastic - black finish  
*Replacement for Whirlpool*



**Order No. ER2191881**

Handle endcap  
Plastic - black finish  
*Replacement for Whirlpool*

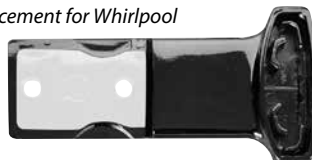

**Order No. ER2191883**

Handle endcap  
Plastic - chrome finish  
*Replacement for Whirlpool*

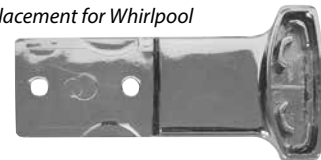

# DEFROST HEATERS

ERP Quartz Tube defrost heaters are engineered for proper lengths, mountings and electrical specifications.

## Order No. ERWR49X391

Quartz tube  
9-3/8" tube length  
625 watts @ 115V  
2 tubes  
*Replacement for GE*



## Order No. ERWR49X392

Quartz tube  
12-1/2" tube length  
775 watts @ 115V  
2 tubes  
*Replacement for GE*



## Order No. ERWR49X393

Calrod  
20-3/4" length  
425 watts @ 115V  
1 tube  
Includes thermal fuses  
*Replacement for GE*



## Order No. ERWR51X413

Quartz tube  
14-7/8" tube length  
420 watts @ 115V  
1 tube  
*Replacement for GE*



## Order No. ERWR51X419

Quartz tube  
17-7/16" tube length  
370 watts @ 115V  
1 tube  
*Replacement for GE*



## Order No. ERWR51X442

Quartz tube  
9-1/2" tube length  
600 watts @ 115V  
2 tubes  
*Replacement for GE*

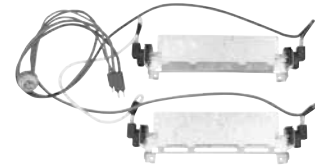

## Order No. ERWR51X443

Quartz tube  
12-13/16" tube length  
770 watts @ 115V  
2 tubes  
*Replacement for GE*



## Order No. ERWR51X444

Quartz tube  
22" tube length  
625 watts @ 115V  
1 tube  
*Replacement for GE*



## Order No. ERWR51X465

Calrod  
22-3/8" length  
443 watts @ 115V  
1 tube  
Includes thermal fuses  
*Replacement for GE*



## Order No. ERWR51X466

Calrod  
26-5/16" length  
470 watts @ 115V  
1 tube  
Includes thermal fuses  
*Replacement for GE*



## Order No. ERWR51X10031

Quartz tube  
9-1/2" tube length  
575 watts @ 115V  
1 tube  
*Replacement for GE*



## Order No. ERWR51X10038

Quartz tube  
21" tube length  
375 watts @ 115V  
1 tube  
*Replacement for GE*



# DEFROST HEATERS

ERP Quartz Tube defrost heaters are engineered for proper lengths, mountings and electrical specifications.

## Order No. ERWR51X10053

Quartz tube  
9-1/2" tube length  
575 watts @ 115V  
1 tube  
*Replacement for GE  
NLA from GE*

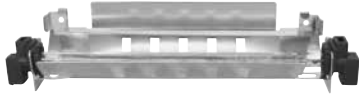

## Order No. ERWR51X10101

Quartz tube  
9-1/2" tube length  
575 watts @ 115V  
2 tubes  
*Replacement for GE*

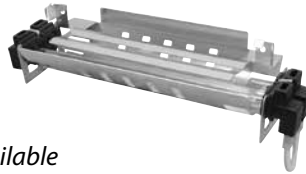

*Both versions still available*

## Order No. ERWR51X10055

Quartz tube  
12" tube length  
725 watts  
1 tube  
*Replacement for GE*



## Order No. ER2263749

Calrod  
475 watts @ 120V  
*Replacement for Whirlpool*



## Order No. ER6010619

Quartz tube  
18" tube length  
420 watts @ 115V  
1 tube  
*Replacement for Whirlpool  
NLA from Whirlpool*



## Order No. ER6010634

Quartz tube  
18" tube length  
410 watts @ 115V  
1 tube  
*Replacement for Whirlpool*



## Order No. ER6010635

Quartz tube  
20-1/4" tube length  
450 watts @ 115V  
1 tube  
*Replacement for Whirlpool*



## Order No. ER61001846

Quartz tube  
10-3/8" tube length  
575 watts @ 115V  
2 tubes  
*Replacement for Whirlpool*

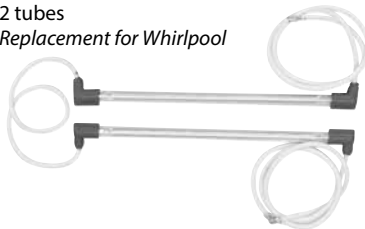

## Order No. ER61001874

Quartz tube  
12" tube length  
650 watts @ 115V  
2 tubes  
*Replacement for Whirlpool*

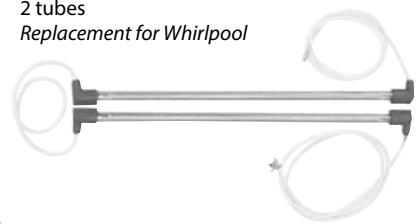

## Order No. ER61001946

Quartz tube  
17-13/16" tube length  
375 watts @ 115V  
1 tube  
*Replacement for Whirlpool*



## Order No. ER61006116

Calrod  
500 watts @ 115V  
*Replacement for Whirlpool*

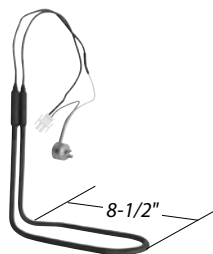

## Order No. ER61006198

Calrod  
500 watts @ 115V  
*Replacement for Whirlpool*

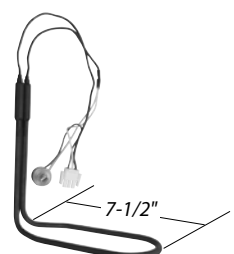



# DEFROST HEATERS

ERP Quartz Tube defrost heaters are engineered for proper lengths, mountings and electrical specifications.

## Order No. ER61006199

Calrod  
600 watts @ 115V  
Replacement for  
Whirlpool

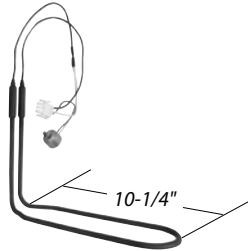

## Order No. ERGH264

Quartz tube  
9-1/4" tube length  
550 watts @ 115V  
2 tubes  
Universal  
Replacement

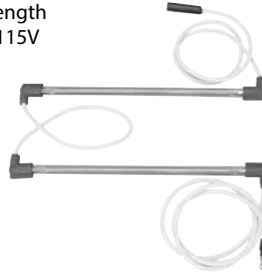

## Order No. ERGH274

Quartz tube  
9-3/4" tube length  
480 watts @ 115V  
2 tubes  
Universal  
Replacement

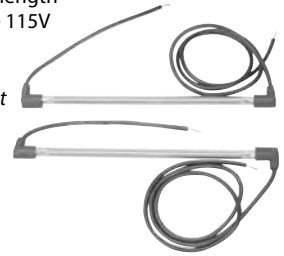

## Order No. ERGH276

Quartz tube  
11-3/8" tube length  
550 watts @ 115V  
2 tubes  
Universal  
Replacement

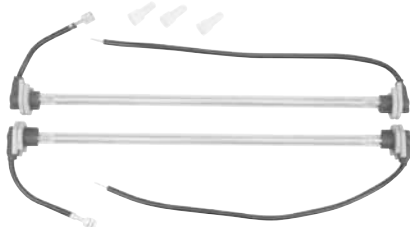

## Order No. ERGH278

Quartz tube  
22-1/4" tube length  
530 watts @ 115V  
1 tube  
Universal Replacement



## Defrost Heater Cross Reference

OEM PN	ERP PN
<b>ELECTROLUX</b>	
00623288	ERGH274
06599346	ERGH274
9956756	ERGH278
5309956756	ERGH278
<b>GE</b>	
WR49X250	ERGH276
WR49X391	ERWR49X391
WR49X392	ERWR49X392
WR49X393	ERWR49X393
WR49X5088	ERGH276
WR49X5106	ERGH276
WR51X411	ERWR51X411
WR51X413	ERWR51X413
WR51X419	ERWR51X419
WR51X442	ERWR51X442
WR51X443	ERWR51X443

OEM PN	ERP PN
WR51X444	ERWR51X444
WR51X465	ERWR51X465
WR51X466	ERWR51X466
WR51X10031	ERWR51X10031
WR51X10038	ERWR51X10038
WR51X10053	ERWR51X10038
WR51X10055	ERWR51X10055
WR51X10101	ERWR51X10101
<b>MAYTAG See Whirlpool</b>	
<b>SUPCO</b>	
SH264	ERGH264
SH274	ERGH274
SH276	ERGH276
SH278	ERGH278
SH303	ERWR49X391
SH306	ERWR49X392
SH307	ERWR51X411
SH308	ERWR51X413

OEM PN	ERP PN
SH309	ERWR51X442
SH310	ERWR51X443
SH311	ER61001846
SH319	ER6010619
SH320	ER6010635
SH374	ER61001874
<b>W.C. WOOD</b>	
332091002	ERWR51X419
<b>WHIRLPOOL</b>	
2263749	ER2263749
4390453	ERWR51X419
4390562	ERWR51X419
52764-1	ERGH264
52764-14	ERGH264
52764-6	ERGH264
52764-8	ERGH264
52764-9	ERGH265
60106-19	ER6010619

OEM PN	ERP PN
60106-34	ER6010634
60106-35	ER6010635
61001846	ER61001846
61001874	ER61001874
61001946	ER61001946
61006116	ER61006116
61006198	ER61006198
61006199	ER61006199

For up-to-date cross reference, go to [www.erparts.com](http://www.erparts.com)

# DEFROST THERMOSTATS

ERP defrost thermostats are 

## Order No. ERGL2690

L47-25F  
Tube mount  
Bullet connectors  
Replacement for Electrolux  
#5316269001, NLA from Electrolux



## Order No. ER218969902

L47-22F  
5/16" side push on clip  
Bullet connectors  
Replacement for Electrolux  
#216872200, NLA from Electrolux



## Order No. ER5303918202

L47-22F  
5/16" side push on clip  
4" & 6" leads with stripped  
wire ends  
Replacement  
for Electrolux  
#5303918202



## Order No. ERWR50X124

L72-44F  
1/2" side push on clip  
24" leads with  
stripped wire ends  
Replacement for GE  
#WR50X124  
NLA from GE



## Order No. ERWR50X134

L63-40F  
1/2" side push on clip  
24" leads with  
stripped wire ends  
Replacement for GE  
#WR50X134  
NLA from GE



## Order No. ERWR50X10021

L64-41F  
3/8" side push on clip  
15" leads with  
stripped wire ends  
Replacement for GE  
#WR50X10071  
NLA from GE



## Order No. ERWR50X10068

L140-30F  
5/16" side push on clip  
11" leads with  
stripped wire ends  
Replacement for GE  
#WR50X10068  
NLA from GE



## Order No. ER61002992

L38-15F  
5/16" side push on clip  
Replacement for Whirlpool #61002992



## Order No. ER61005254

L54-15F  
1/4" side push on clip  
Replacement for Whirlpool #61005254



## Order No. ER4387489

L70-58F  
6" leads with  
stripped wire ends  
Replacement for  
Whirlpool #4387489



## Order No. ER4387490

L6.7-14.5C  
5/16" side push on clip  
5-1/2" leads with stripped wire ends  
Replacement for Whirlpool  
#4387490

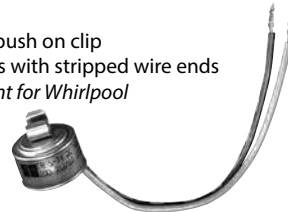

## Order No. ERWR55X10025

Refrigerator  
Temperature  
Sensor

Replacement for GE  
#WR55X10025

**NEW!**



Order No. ERML45 open @ 45 - close @ 25

Order No. ERML50 open @ 50 - close @ 30

Order No. ERML55 open @ 55 - close @ 35

Order No. ERML60 open @ 60 - close @ 40

Order No. ERML70 open @ 70 - close @ 50

**UNIVERSAL**



Order No. ERMLT45 open @ 45 - close @ 25

Order No. ERMLT50 open @ 50 - close @ 30

Order No. ERMLT55 open @ 55 - close @ 35

Order No. ERMLT60 open @ 60 - close @ 40

Order No. ERMLT70 open @ 70 - close @ 50

**UNIVERSAL**

**NEW!**

24" lead wires



REFRIGERATION

# DEFROST TIMERS

ERP defrost timers are 

## Order No. ERWR9X480

6 hr. 30 min.  
Replacement for GE #WR9X480, Supco #SC957

## Order No. ERWR9X481

6 hr. 25 min.  
Replacement for GE #WR9X481, Supco #SC950

## Order No. ERWR9X483

10 hr. 30 min.  
Replacement for GE #WR9X483, Supco #SC954

## Order No. ERWR9X489

16 hr. 35 min.  
Replacement for GE #WR9X489

## Order No. ERWR9X502

8 hr. 30 min.  
Replacement for GE #WR9X502

## Order No. ERWR9X520

15 hr. 44 min.  
Replacement for GE #WR9X520

## Order No. ERWR9X548

6 hr. 25 min.  
Replacement for: GE #WR9X548

## Order No. ERWR09X10041

12 hr. 33 min.  
Replacement for GE #WR09X10041

## Order No. ERWR09X10049

15 hr. 34 min.  
Replacement for GE #WR09X10049



## Order No. ER215846602

8 hr. 30 min.  
Replacement  
for Electrolux  
#215846602



## Order No. ER241809402

10 hr. 30 min.  
Replacement  
for Electrolux  
#241809402



## Order No. ERWR9X330DS

10 hr. 30 min.  
Replacement for GE  
GE #WR9X330DS

**NEW!**

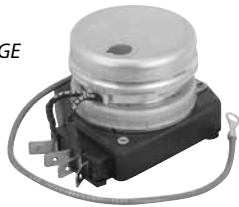

## Order No. ER2183400

8 hr. 25 min.  
Includes mounting  
bolts  
Replacement  
for Whirlpool  
#2183400

Large  
mounting  
hole



## Order No. ER4390515

10 hr. 35 min.  
Replacement  
for Whirlpool  
#4390515



## Order No. ER482493

8 hr. 21 min.



Replacement for Whirlpool #482493

## Order No. ERGP1

6 hr. 21 min.  
Replacement for  
Electrolux  
#215846604  
Maytag #66128-1  
Supco #SPA1401AD



## Order No. ERGP11

8 hr. 21 min.  
Replacement for  
Electrolux  
#215846602  
Supco #SPB1401F



## Order No. ERGP20

6 hr. 21 min.  
Replacement for  
Electrolux #5303917633

## Order No. ERGP21

8 hr. 21 min.  
Replacement for  
Electrolux #5303917634



## Order No. ER61005988

Adaptive Defrost Control  
ER61005988 can also be used as a diagnostic tool  
The LED light tells you:

- when compressor is running
- when defrost heaters are on
- when cold control fails (open & closed)
- when defrost heater or bi-metal thermo fails open
- when bi-metal thermo fails closed
- when defrost control fails or there is a power failure

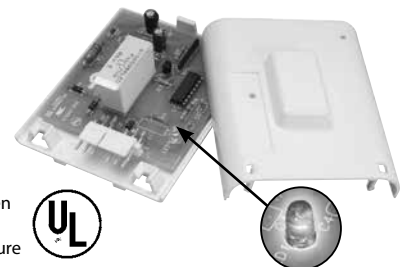

# SPUN COPPER DRIERS

ERP offers a full line of spun copper drier filters suitable for all refrigerants including R134A. Offering both economy styles (similar to OEM production) or heavy duty service driers which insure system performance after service in extreme or humid ambient conditions.

## Order No. ERD103

Directional  
Inlet: 1/4" Outlet: 1/4"  
Process tube: NA  
Diameter: 1"  
Recommended tonnage:  
(R-12) 3/4 (R-22) 1/2



Also fits: Supco #SUD103

Regular duty w/ rubber plug ends

## Order No. ERD109

Non-directional  
Inlet: 1/4" Outlet: 1/4"  
Process tube: NA  
Diameter: 3/4"  
Recommended tonnage:  
(R-12) 3/4 (R-22) 1/2



Also fits: Supco #SUD109

Economy w/ extended and fused ends

## Order No. ERD110

Directional  
Inlet: 1/4" Outlet: Cap + 1/4"  
Process tube: NA  
Diameter: 3/4"  
Recommended tonnage:  
(R-12) 3/4 (R-22) 1/2



Also fits: Supco #SUD110

Heavy duty w/ large cup screens for additional filtration, fused and scored ends

## Order No. ERD111

Directional  
Inlet: 1/4" Outlet: Cap + 1/4"  
Process tube: 3/16"  
Diameter: 1"  
Recommended tonnage:  
(R-12) 1-1/2 (R-22) 3/4



Also fits: Supco #SUD111

Heavy duty w/ Schrader to evacuate or charge the system, fused and scored ends

## Order No. ERD112

Directional  
Inlet: 5/16" Outlet: Cap + 5/16"  
Process tube: NA  
Diameter: 1"  
Recommended tonnage:  
(R-12) 2-1/2 (R-22) 2



Also fits: Supco #SUD112

Heavy duty w/ large cup screens for additional filtration, fused and scored ends

## Order No. ERD113

Directional  
Inlet: 1/4" Outlet: Cap + 1/4"  
Process tube: 1/4"  
Diameter: 1"  
Recommended tonnage:  
(R-12) 1-1/2 (R-22) 3/4



Also fits: Supco #SUD113

High capacity service drier w/ access fitting tube, fused and scored ends

## Order No. ERD114

Directional  
Inlet: Swaged 1/4" Outlet: Cap + 1/4"  
Process tube: NA  
Diameter: 1"  
Recommended tonnage:  
(R-12) 1-1/2 (R-22) 3/4



Also fits: Supco #SUD114

High capacity, fused and scored ends

## Order No. ERD115

Directional  
Inlet: 1/4" Outlet: Cap + 1/4"  
Process tube: 3/16"  
Diameter: 3/4"  
Recommended tonnage:  
(R-12) 3/4 (R-22) 1/2



Also fits: Supco #SUD115

Economy w/ Schrader to evacuate or charge the system, fused and scored ends

# EVAPORATOR MOTORS

Order No. ER240369701

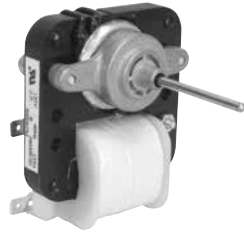

Replaces  
Electrolux #240369701  
#5304445861

Order No. ER241696605



Condenser Motor

Replaces Electrolux #241696605

Order No. ER241854301

**NEW!**



Replaces Electrolux #241854301

Order No. ER241854401

**NEW!**



Replaces Electrolux #241854401

Order No. ER5300158289



Replaces  
Electrolux #5300158289  
Supco #SM336

Order No. ER5303918549

**NEW!**

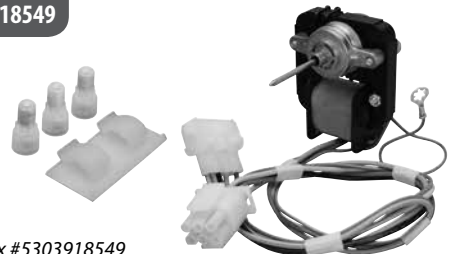

Replaces Electrolux #5303918549

Order No. ERWR60X162



Replaces  
GE #WR60X162  
Supco #SM338

Order No. ERWR60X190



Replaces  
GE #WR60X190  
Supco #SM344

Order No. ERWR60X191



Replaces  
GE #WR60X191  
Supco #SM391

Order No. ERWR60X203



Replaces GE WR60X203

# EVAPORATOR MOTORS

**Order No. ERWR60X10028**

Condenser Motor  
115V  
1-1/4" shaft  
Has quick disconnect

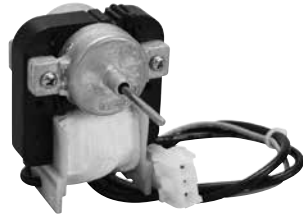

Replaces GE #WR60X10168

**Order No. ERWR60X10129**



Replaces GE #WR60X10129,  
#WR60X10257

**Order No. ERWR60X10141**



Replaces GE #WR60X10141

**Order No. ERWR60X10172**



Replaces GE #WR60X10172

**Order No. ERDA31-00103A**

**NEW!**



Replaces Samsung #DA31-00103A

**Order No. ER12002744**

Includes wire harness

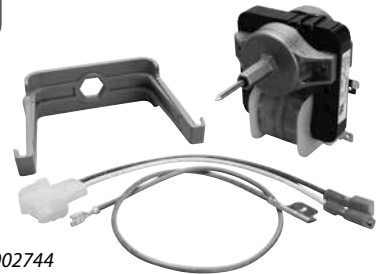

Replaces Whirlpool #12002744

**Order No. ER4389142**

**NEW!**



Replaces Whirlpool #4389142

**Order No. ER4389144**

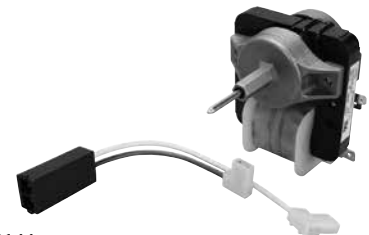

Replaces Whirlpool #4389144

**Order No. ER4389145**

**NEW!**

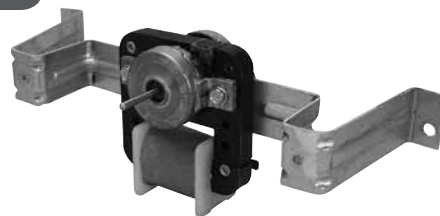

Replaces Whirlpool #4389145

**Order No. ER482468**



Replaces  
Supco #SM327  
Whirlpool #482468

REFRIGERATION



# EVAPORATOR MOTORS

**Order No. ER482469**



Replaces  
Supco #SM328  
Whirlpool #482469

**Order No. ER482731**

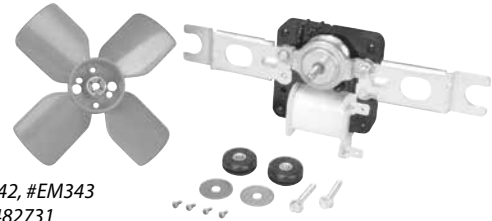

Replaces  
Supco #EM342, #EM343  
Whirlpool #482731

**Order No. ERW10189703**



Replaces Whirlpool #W10189703

**Order No. ER61004888**



Replaces Whirlpool #61004888

**Order No. ER61005935**

With ERP's new harness, this c-frame motor will replace Maytag #61005935 & #61005339 motors made by Panasonic

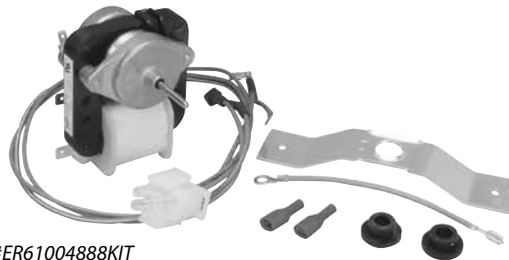

Replaces Whirlpool #61005935  
Also fits: Whirlpool #61005339, #61004888, #ER61004888KIT

**Order No. ERM241**

GEM PN: #EM241  
CW/CCW Rotation  
SHAFT: Dia: Hub  
Length: 3/4"



Universal Replacement  
for 200 Series

**Order No. ERM245**

GEM PN: #EM245  
CW/CCW Rotation  
SHAFT:  
Dia: 1/8"  
Length: 1-3/4"

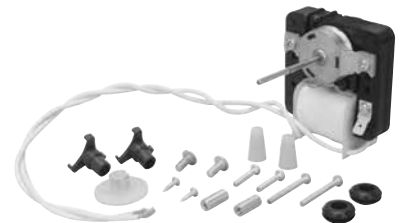

Universal Replacement  
for 200 Series

**Order No. ERM248**

GEM PN: #EM248  
CW/CCW Rotation  
SHAFT:  
Dia: 3/16" Length: 2-3/4"



Universal Replacement  
for 200 Series

**Order No. ERM249**

GEM PN: #EM249  
CW/CCW Rotation  
SHAFT: Dia: 1/8"  
Length: Break Away

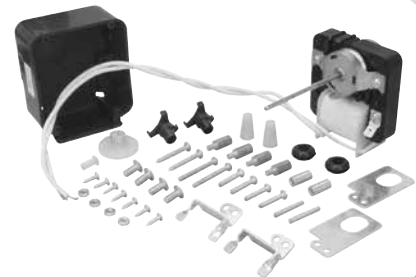

Universal Replacement  
for 200 Series

# EVAPORATOR MOTORS

## 200 SERIES CROSS REFERENCE

OEM Part #	ERP #
<b>ADMIRAL</b> See Whirlpool	
<b>AMANA</b> See Whirlpool	
<b>ELECTROLUX</b>	
620365	ERM241
620929	ERM241
620962	ERM241
621086	ERM241
621891	ERM241
622462	ERM241
622852	ERM241
622892	ERM241
622937	ERM241
623048	ERM241
623319	ERM241
623686	ERM241
625094	ERM241
625647	ERM241
627283	ERM241
627286	ERM241
627289	ERM241
627293	ERM241
627879	ERM248
628530	ERM241
628531	ERM241
629966	ERM241
629968	ERM241
1135442	ERM248
1135914	ERM248
6598467	ERM241
6598468	ERM241
6598503	ERM241
6598507	ERM241
6599014	ERM241
6599015	ERM241
6599016	ERM241
6599017	ERM241
6599388	ERM241
6599389	ERM241
6599390	ERM241

OEM Part #	ERP #
6599391	ERM241
7515434	ERM241
7515803	ERM241
7516385	ERM241
7516386	ERM241
7516457	ERM241
7517873	ERM241
7543975	ERM241
7544495	ERM241
7546178	ERM241
7546181	ERM241
7546735	ERM241
9956921	ERM241
9956922	ERM241
9956924	ERM241
5104-050-10	ERM245
5104-050-13	ERM245
5104-050-15	ERM245
5104-050-3	ERM249
5104-050-6	ERM249
5300158289	ERM245
5301135442	ERM248
5301135914	ERM248
5301230532	ERM245
5306599388	ERM241
5306599389	ERM241
5308010661	ERM245
C28542	ERM245
C28543	ERM245
C28545	ERM245
C28546	ERM245
C38088	ERM245
C38089	ERM245
C38090	ERM245
C38785	ERM245
C38788	ERM245
C38791	ERM245
C460752	ERM245
C48507	ERM245

OEM Part #	ERP #
C57230	ERM245
C712838	ERM245
G146620	ERM245
G152646	ERM245
G158289	ERM249
K1159624	ERM245
K1159782	ERM245
K1159808	ERM245
K1166681	ERM245
K1166971	ERM245
K1167246	ERM245
K1202158	ERM245
K1202159	ERM245
K1204665	ERM245
K1204667	ERM245
K1205028	ERM245
K1206352	ERM245
K1206353	ERM245
K1206354	ERM245
K1206452	ERM245
K1206453	ERM245
K1208099	ERM245
K1209560	ERM245
K1220352	ERM245
K1222931	ERM245
K1226505	ERM245
K1226507	ERM245
K1227015	ERM245
K1227017	ERM245
K1228883	ERM245
K1230532	ERM245
<b>GE/HOTPOINT</b>	
106348	ERM248
106349	ERM248
115560	ERM245
132960	ERM245
132968	ERM245
133602	ERM245
136611	ERM245

OEM Part #	ERP #
139295	ERM248
WR49X5039	ERM248
WR49X5040	ERM248
WR49X5082	ERM245
WR60X52	ERM245
WR60X54	ERM245
WR60X60	ERM245
WR60X65	ERM245
WR60X71	ERM245
WR60X74	ERM245
WR60X82	ERM245
WR60X84	ERM245
WR60X85	ERM245
WR60X88	ERM245
WR60X96	ERM245
WR60X100	ERM245
WR60X104	ERM245
WR60X105	ERM245
WR60X108	ERM245
WR60X112	ERM245
WR60X118	ERM245
WR60X120	ERM245
WR60X122	ERM245
WR60X125	ERM245
WR60X126	ERM245
WR60X127	ERM245
WR60X129	ERM245
WR60X130	ERM245
WR60X131	ERM245
WR60X132	ERM245
WR60X162	ERM245
WR60X163	ERM245
WR60X168	ERM245
WR60X171	ERM245
WR60X5005	ERM245
WR60X5011	ERM245
WR60X5012	ERM248
WR60X5016	ERM245
WR60X5020	ERM245

For up-to-date cross reference, go to [www.erparts.com](http://www.erparts.com)

# EVAPORATOR MOTORS

## 200 SERIES CROSS REFERENCE

OEM Part #	ERP #
WR60X5021	ERM245
WR60X5035	ERM245
WR60X5040	ERM245
WR60X5046	ERM245
WR60X5047	ERM245
WR60X5048	ERM248
WR60X5049	ERM245
WR60X5060	ERM245
WR60X5068	ERM248
WR60X5073	ERM245
<b>GIBSON</b> See Electrolux	
<b>PHILCO</b> See Electrolux	
<b>WESTINGHOUSE</b> See Electrolux	
<b>WHIRLPOOL</b>	
23464	ERM248
26999	ERM248
27779	ERM248
27842	ERM248
28512	ERM248
29708-1	ERM245
480632	ERM241
480639	ERM241
480657	ERM241
481384	ERM241
482467	ERM241
482468	ERM241
482495	ERM241
510672	ERM241

OEM Part #	ERP #
513580	ERM241
513923	ERM241
515235	ERM241
515240	ERM241
517441	ERM241
517472	ERM241
518707	ERM241
518782	ERM241
519218	ERM241
520024	ERM241
53000-1	ERM248
53003-1	ERM248
530314	ERM241
530452	ERM241
530675	ERM241
530763	ERM241
531646	ERM241
531647	ERM241
531648	ERM241
531826	ERM241
531885	ERM241
531916	ERM241
54482-3	ERM245
547388	ERM241
547954	ERM241
547956	ERM241
547958	ERM241
548042	ERM241

OEM Part #	ERP #
55394-1	ERM248
55394-2	ERM248
55394-3	ERM248
55394-5	ERM248
55394-7	ERM248
55735-1	ERM248
55735-8	ERM248
56488-1	ERM248
56488-2	ERM248
56488-3	ERM248
56488-4	ERM248
56488-5	ERM248
833502	ERM241
833528	ERM241
833752	ERM241
938296	ERM249
1105608	ERM249
1105609	ERM249
C303599	ERM248
C35256-1	ERM241
C35258-2	ERM241
C35363-1	ERM245
C35363-7	ERM245
C35656-1	ERM245
C35656-5	ERM245
C35657-1	ERM241
C35759-1	ERM245
C35759-5	ERM245

OEM Part #	ERP #
C35759-6	ERM245
C35759-7	ERM245
C36806-1	ERM248
C36806-2	ERM248
C36811-1	ERM245
C36840-1	ERM248
C87131-1	ERM248
D71157-1	ERM245
D71157-2	ERM245
D71157-3	ERM245
D71157-4	ERM245
D71157-6	ERM245
D71157-7	ERM245
D72414-12	ERM249
D72414-9	ERM249
D72560-3	ERM245
D72562-1	ERM245
D72562-3	ERM245
M3020-1	ERM248
M3020-2	ERM248
M3035-1	ERM248
M3035-2	ERM248
M3035-4	ERM248
R0151002	ERM245
R1570-87	ERM245
RA95052-1	ERM248

For up-to-date cross reference, go to [www.erparts.com](http://www.erparts.com)

# DOOR GASKETS

SAVE with the industry's most popular line up.  
We have followed the OEM's standardization to supply a broad line of replacements with fewer part numbers.

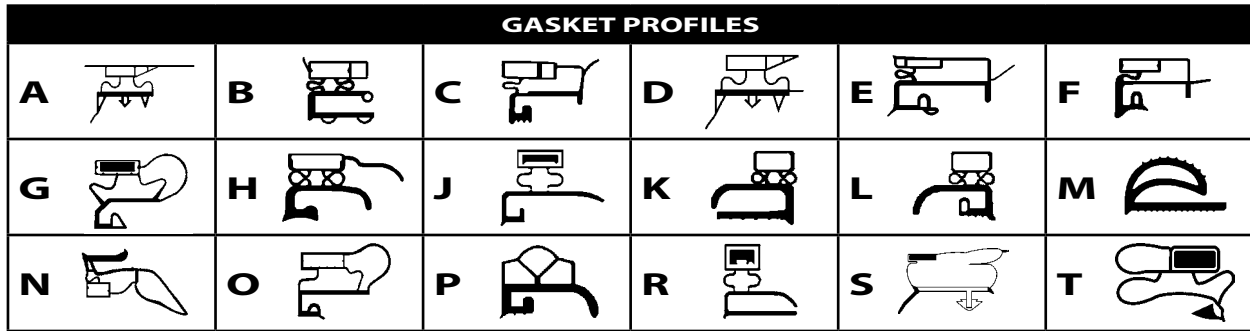

## DOOR GASKETS

Part No.	Profile	Color
<b>AMANA</b> <i>See Whirlpool</i>		
<b>ELECTROLUX</b>		
ER2188433A	G	White
ER2188434A	G	White
ER215019101	F	Almond
ER215019102	F	Almond
ER215019103	F	Almond
ER215019104*	F	Almond
ER215019105*	F	Almond
ER215019106*	F	Almond
ER215732415	F	White
ER215740402	F	White
ER218730601	F	White
ER218730603	F	White
ER218730604	F	White
ER218730605	F	White
ER218730606	F	White
ER218730609	F	White
ER218730610	F	Almond
ER241872501†	S	White
ER241872502†	S	White
ER241872503†	S	White
ER241872504†	S	White
ER241872507†	S	Black <b>NEW!</b>
ER241872509†	S	Black <b>NEW!</b>
ER241872510†	S	Black <b>NEW!</b>
ER241872511†	S	Black <b>NEW!</b>
ER241872512†	S	Black <b>NEW!</b>
ER241872513†	S	White
ER241872514†	S	Black <b>NEW!</b>
ER5300628042*	J	White

Part No.	Profile	Color
ER5301124534*	J	White
ER5303001317*	F	Brown
ER5303207345	F	White
ER5303276826	F	Almond
ER5303288238	F	Beige
ER5303288856	F	Almond
ER5303297557	F	Brown
ER5303309874	C	White
ER5304403828	F	White
ER5304404033	F	Almond
ER5304404034	F	White
ER5304404035	F	White
ER5304404036	F	Almond
ER5304404037	F	White
ER5307510058*	J	White
ER5308007123	F	White
ER5308007124	F	White
ER5318680302	F	White
<b>GENERAL ELECTRIC</b>		
ERWR24X3*	R	White
ERWR24X220	P	White
ERWR24X233*	J	White
ERWR24X246	C	White
ERWR24X260*	P	White
ERWR24X261*	P	White
ERWR24X266*	P	White
ERWR24X271	J	White
ERWR24X272	J	White
ERWR24X273	J	White
ERWR24X274	J	White
ERWR24X276	J	White
ERWR24X277*	J	White

Part No.	Profile	Color
ERWR24X284	J	Brown
ERWR24X285*	J	Brown
ERWR24X286	C	White
ERWR24X287	J	Brown
ERWR24X295	C	Brown
ERWR24X298*	J	White
ERWR24X300	C	Brown
ERWR24X301	J	Brown
ERWR24X302	C	White
ERWR24X303	J	White
ERWR24X309	J	Brown
ERWR24X311	J	White
ERWR24X312	H	White
ERWR24X313	J	White
ERWR24X315	C	White
ERWR24X317*	F	White
ERWR24X318	J	Brown
ERWR24X319	J	White
ERWR24X389*	J	Brown
ERWR24X390	J	Brown
ERWR24X391	C	White
ERWR24X416	C	Brown
ERWR24X421	C	Brown
ERWR24X422	C	White
ERWR24X424	C	Brown
ERWR24X432	C	Brown
ERWR24X433	C	White
ERWR24X435	D	Brown
ERWR24X437	D	White
ERWR24X438	D	White
ERWR24X445	D	White
ERWR24X446	D	White

\*SPECIAL ORDER GASKET - 3 to 6 week delivery

† Due to shipping concerns, you must order a minimum of 2 rigid style gaskets (you may mix and match)

All logos, trademarks, part numbers, photos & illustrations are intended solely for identification.  
Items offered for sale are not represented to be manufactured by the company that built the original equipment.

# DOOR GASKETS

## DOOR GASKETS

Part No.	Profile	Color
ERWR24X449	D	White
ERWR24X450	A	White
ERWR24X464	C	Brown
ERWR24X481	D	Brown
ERWR24X484	D	White
ERWR24X490*	H	Brown
ERWR24X524	D	White
ERWR24X527	C	White
ERWR24X528	C	White
ERWR24X550	C	White
ERWR24X558	D	White
ERWR24X5103*	R	White
ERWR24X5105*	J	White
ERWR24X5212	C	White
ERWR24X5231	C	White
ERWR24X5232	C	White
ERWR24X5238*	F	White
ERWR24X5258	C	White
ERWR24X10186	D	White
ERWR24X10228	D	White
ERWR24X10229	D	White
ERWR24X10231	D	White
ERWR24X10236	D	White
<b>MAYTAG</b> See Whirlpool		
<b>WHIRLPOOL</b>		
ER10359708Q	O	White
ER10359709Q	O	White
ER1129252	H	White
ER12550101Q	F	Black
ER12550109Q	F	White
ER12550111Q	F	White
ER12550112Q	F	White
ER12550115Q	F	White
ER12550116Q	F	White
ER2159057†	S	White <b>NEW!</b>
ER2159061†	S	White <b>NEW!</b>
ER2188404A	G	Mist Beige
ER2188405A	G	White
ER2188433A	G	Mist Beige
ER2188434A	G	Mist Beige
ER2188435A	G	White
ER2188436A	G	White

Part No.	Profile	Color
ER2188438A	G	White
ER2188439A	G	White
ER2188442A	G	White
ER2188444A	G	Mist Beige
ER2188445A	G	Mist Beige
ER2188446A	G	White
ER2188447A	G	White
ER2188448A	G	Mist Beige
ER2188450A	G	Mist Beige
ER2188451A	G	White
ER2188456A	G	Mist Beige
ER2188458A	G	Mist Beige
ER2188460A	G	Mist Beige
ER2188461A	G	Mist Beige
ER2188462A	G	Mist Beige
ER2188463A	G	Mist Beige
ER2262080	G	White
ER2262081	G	White
ER2319263T†	T	White
ER2319264T†	T	White
ER2319265T†	T	White
ER2319266T†	T	White
ER4343449	H	White
ER4387565	G	Mist Beige
ER4387590	G	Mist Beige
ER4387604	G	Mist Beige
ER4387626	G	Mist Beige
ER4390530	S	White <b>NEW!</b>
ER510342*	J	White
ER510343*	J	White
ER510344*	J	White
ER510345*	J	White
ER528919*	J	White
ER61003998	N	White
ER61003999	N	White
ER61004002	N	White
ER61004003	N	White
ER61004006	N	White
ER61004007	N	White
ER61004008	N	White
ER653209*	J	White
ER658998*	J	White
ER669291*	B	White
ER6692914*	B	White

Part No.	Profile	Color
ER669298*	B	White
ER700252	B	White
ER700253	B	White
ER700254	B	White
ER700255	B	White
ER700256	B	White
ER700471	E	White
ER700472	E	White
ER700473	E	White
ER700481	E	White
ER700482	E	White
ER700483	E	White
ER700484	E	White
ER838141*	J	White
ER848395	J	White
ER876480*	J	White
ER876483*	J	White
ERD7092602Q*	J	White
ERD7092608Q*	J	White
ERD7092609Q*	J	White
ERD7251020Q	G	Almond
ERD7605106Q*	O	White
ERD7605107Q	F	White
ERD7605109Q	F	White
ERD7605115Q	F	White
ERD7605116Q	F	White
<b>UNIVERSAL ROLLS (BULK)</b>		
ERP6662	M	100'
<b>UNIVERSAL - 2 PIECE KIT</b>		
ER2204	K	36" x 68"
ER2213	L	36" x 68"
<b>UNIVERSAL - 4 PIECE KIT</b>		
ER2001	K	20" x 30"
ER2002	K	32" x 42"
ER2003	K	32" x 55"
ER2004	K	36" x 84"
ER2301	L	20" x 30"
ER2302	L	32" x 42"
ER2303	L	32" x 55"
ER2304	L	36" x 84"

\*SPECIAL ORDER GASKET - 3 to 6 week delivery

† Due to shipping concerns, you must order a minimum of 2 rigid style gaskets (you may mix and match)

All logos, trademarks, part numbers, photos & illustrations are intended solely for identification. Items offered for sale are not represented to be manufactured by the company that built the original equipment.

# DOOR GASKETS

## Door Gasket Cross Reference

OEM Part #	ERP #
<b>AMANA</b> <i>See Whirlpool</i>	
<b>ELECTROLUX</b>	
215019101	ER215019101
215019102	ER215019102
215019103	ER215019103
215019104*	ER215019104*
215019105*	ER215019105*
215019106	ER215019106
215608906	ER5303288238
215608911	ER5308007123
215608941	ER5308007123
215608971	ER5308007123
215732402	ER218730604
215732411	ER5318680302
215732412	ER218730603
215732415	ER215732415
215732462	ER218730604
215740402	ER215740402
215776711	ER5308007123
218730601	ER218730601
218730603	ER218730603
218730604	ER218730604
218730605	ER218730605
218730609	ER218730609
218730610	ER218730610
241872501	ER241872501
241872502	ER241872502
241872503	ER241872503
241872504	ER241872504
241872507	ER241872507
241872509	ER241872509
241872510	ER241872510
241872511	ER241872511
241872512	ER241872512
241872513	ER241872513
241872514	ER241872514
3200261	ER218730603
3206466	ER218730606
5300628042*	ER5300628042*
5301124534*	ER5301124534*
5303001049	ER215019106
5303001317	ER5303001317
5303001486	ER5303276826
5303018792	ER218730609

OEM Part #	ERP #
5303200258*	ER5308007123
5303200473	ER215019102
5303200474	ER215019103
5303201811	ER215019101
5303207345	ER5303207345
5303271473	ER218730601
5303276826	ER5303276826
5303288238	ER5303288238
5303288239	ER218730606
5303288856	ER5303288856
5303288857	ER218730604
5303297557	ER5303297557
5303309874	ER5303309874
5304403828	ER5304403828
5304404033	ER5304404033
5304404034	ER5304404034
5304404035	ER5304404035
5304404036	ER5304404036
5304404037	ER5304404037
5307510058*	ER5307510058*
5308006509	ER2188433A
5308006510	ER2188434A
5308007122	ER5318680302
5308007123	ER5308007123
5308007124	ER5308007124
5308015544	ER218730610
5308016627	ER5304404036
5308016628	ER5304404035
5318680302	ER5318680302
5318680311	ER218730603
5318693207	ER5304404033
<b>GENERAL ELECTRIC</b>	
WR24X3*	ERWR24X3*
WR24X220	ERWR24X220
WR24X233*	ERWR24X233*
WR24X246	ERWR24X246
WR24X260*	ERWR24X260*
WR24X261*	ERWR24X261*
WR24X266*	ERWR24X266*
WR24X271	ERWR24X271
WR24X272	ERWR24X272
WR24X273	ERWR24X273
WR24X274	ERWR24X274
WR24X276	ERWR24X276

OEM Part #	ERP #
WR24X277	ERWR24X277
WR24X284	ERWR24X284
WR24X285	ERWR24X285
WR24X286	ERWR24X286
WR24X287	ERWR24X287
WR24X291	ERWR24X421
WR24X292	ERWR24X274
WR24X295	ERWR24X295
WR24X298	ERWR24X298
WR24X299	ERWR24X421
WR24X300	ERWR24X300
WR24X301	ERWR24X301
WR24X302	ERWR24X302
WR24X303	ERWR24X303
WR24X309	ERWR24X309
WR24X311	ERWR24X311
WR24X312	ERWR24X312
WR24X313	ERWR24X313
WR24X315	ERWR24X315
WR24X317	ERWR24X317
WR24X318	ERWR24X318
WR24X319	ERWR24X319
WR24X389	ERWR24X421
WR24X390	ERWR24X390
WR24X391	ERWR24X391
WR24X413	ERWR24X287
WR24X416	ERWR24X416
WR24X421	ERWR24X421
WR24X422	ERWR24X422
WR24X424	ERWR24X424
WR24X429	ERWR24X421
WR24X433	ERWR24X433
WR24X435	ERWR24X435
WR24X437	ERWR24X437
WR24X438	ERWR24X438
WR24X445	ERWR24X445
WR24X446	ERWR24X446
WR24X449	ERWR24X449
WR24X450	ERWR24X450
WR24X464	ERWR24X464
WR24X481	ERWR24X481
WR24X484	ERWR24X10228
WR24X485	ERWR24X10231
WR24X486	ERWR24X10229

OEM Part #	ERP #
WR24X514	ERD7605116Q
WR24X518	ERWR24X10231
WR24X524	ERWR24X10228
WR24X524	ERWR24X524
WR24X527	ERWR24X527
WR24X528	ERWR24X528
WR24X550	ERWR24X550
WR24X558	ERWR24X558
WR24X5103*	ERWR24X5103*
WR24X5105*	ERWR24X5105*
WR24X5206	ERWR24X421
WR24X5207	ERWR24X421
WR24X5212	ERWR24X5212
WR24X5231	ERWR24X5231
WR24X5232	ERWR24X5232
WR24X5237	ERD7605116Q
WR24X5238*	ERWR24X5238*
WR24X5258	ERWR24X5258
WR24X10049	ERWR24X10231
WR24X10050	ERWR24X10228
WR24X10051	ERWR24X10229
WR24X10052	ERWR24X10236
WR24X10186	ERWR24X10186
WR24X10228	ERWR24X10228
WR24X10229	ERWR24X10229
WR24X10231	ERWR24X10231
WR24X10236	ERWR24X10236
<b>GEMLINE</b>	
2001	ER2001
2002	ER2002
2003	ER2003
2004	ER2004
2213	ER2213
2301	ER2301
2302	ER2302
2303	ER2303
2304	ER2304
AD67	ER700471
AD68	ER700481
AD69	ER700472
AD70	ER700482
AD71	ER700473
AD72	ER700483
AD73	ER700484

\*SPECIAL ORDER GASKET - 3 to 6 week delivery

For up-to-date cross reference, go to [www.erparts.com](http://www.erparts.com)



# DOOR GASKETS

## Door Gasket Cross Reference

OEM Part #	ERP #
CS43	ER2188460A
CS44	ER2188404A
CS46	ER4387590
CS49	ER1129252
CS52	ER2188445A
CS56	ER2188433A
CS58	ER2188434A
FR109	ER215019103
FR110	ER215019101
FR116	ER215019106
FR117	ER218730609
FR118	ER218730610
FR119	ER218730604
FR120	ER5303297557
FR121	ER5303288856
FR123	ER5308007123
FR26	ER218730603
FR45	ER5303276826
FR90	ER5303207345
GE111	ERWR24X274
GE127	ERWR24X313
GE128	ERWR24X301
GE129	ERWR24X303
GE132	ERWR24X286
GE134	ERWR24X309
GE136	ERWR24X390
GE139	ERWR24X312
GE141	ERWR24X311
GE147	ERWR24X277
GE156	ERWR24X302
GE158	ERWR24X308
GE159	ERWR24X317
GE171	ERWR24X391
GE174	ERWR24X416
GE287	ERWR24X287
GE449	ERWR24X449
GE450	ERWR24X450
GE484	ERWR24X484
GE5232	ERWR24X5232
GE558	ERWR24X558
GI43	ER5304404033
WC12	ER218730610
WP12	ER2188444A
WP14	ER2188445A

OEM Part #	ERP #
WP28	ER4387565
WP566	ER2188456A
WP567	ER2188463A
WP570	ER2188461A
WP572	ER2188460A
WP577	ER2188458A
WP590	ER4387590
WP591	ER2188450A
WP604	ER4387604
WP608	ER2188445A
WP609	ER2188444A
WP622	ER2188404A
WP626	ER4387626
WP634	ER2188434A
WP638	ER2188433A
WP99	ER4387604
<b>MAYTAG</b> <i>See Whirlpool</i>	
<b>SUB-ZERO</b>	
3211080	ER7010573
3211100	ER7010575
3211140	ER7010578
3212100	ER7010583
3212110	ER7010584
7010573	ER7010573
7010574	ER7010574
7010575	ER7010575
7010578	ER7010578
7010583	ER7010583
7010584	ER7010584
7010592	ER7010592
7010609	ER7010609
<b>SUPCO</b>	
SAD67	ER700471
SAD68	ER700481
SAD69	ER700472
SAD70	ER700482
SAD71	ER700473
SAD72	ER700483
SAD73	ER700484
SAD96	ER700253
SAD97	ER700254
SAM55	ER12550109Q
SAM59	ER12550116Q
SCS100	ER2188461A

OEM Part #	ERP #
SCS102	ER2188456A
SCS103	ER2188458A
SCS105	ER2188404A
SCS115	ER2188445A
SCS116	ER2188433A
SCS36	ER4387590
SCS42	ER2188450A
SCS43	ER2188460A
SCS44	ER2188404A
SCS46	ER4387590
SCS49	ER1129252
SCS70	ER2188444A
SCS75	ER2188444A
SCS80	ER2188463A
SCS84	ER2188450A
SCS92	ER2188460A
SCS93	ER4387565
SCS97	ER2188434A
SCS99	ER4387604
SGE111	ERWR24X274
SGE112	ERWR24X273
SGE127	ERWR24X313
SGE276	ERWR24X276
SGE277	ERWR24X277
SGE284	ERWR24X284
SGE285	ERWR24X285
SGE286	ERWR24X286
SGE287	ERWR24X287
SGE301	ERWR24X301
SGE302	ERWR24X302
SGE303	ERWR24X303
SGE308	ERWR24X308
SGE309	ERWR24X309
SGE311	ERWR24X311
SGE312	ERWR24X312
SGE317	ERWR24X317
SGE318	ERWR24X318
SGE319	ERWR24X319
SGE390	ERWR24X390
SGE391	ERWR24X391
SGE416	ERWR24X416
SGE421	ERWR24X421
SGE446	ERWR24X446
SGE449	ERWR24X449

OEM Part #	ERP #
SGE450	ERWR24X450
SGE481	ERWR24X481
SGE484	ERWR24X484
SGE5212	ERWR24X5212
SGE5231	ERWR24X5231
SGE5232	ERWR24X5232
SGE524	ERWR24X524
SGE5258	ERWR24X5258
SGE527	ERWR24X527
SGE528	ERWR24X528
SGE550	ERWR24X550
SGE558	ERWR24X558
SGI43	ER5308007123
SGI44	ER5308007124
SGI47	ER5304404033
SU2001	ER2001
SU2002	ER2002
SU2003	ER2003
SU2004	ER2004
SU2213	ER2213
SU2301	ER2301
SU2302	ER2302
SU2303	ER2303
SU2304	ER2304
SWC12	ER218730610
SWC13	ER5304404036
SWC21	ER5318680302
SWC23	ER5318680305
SWC26	ER218730603
SWC34	ER5303276826
SWC36	ER215019106
SWC37	ER215019102
SWC38	ER215019103
SWC39	ER215019101
SWC41	ER218730604
SWC45	ER5303276826
SWC59	ER218730609
SWC60	ER218730610
SWC61	ER5303207345
SWC63	ER215740402
SWC65	ER5303270902
SWC69	ER5303001317
SZO573	ER7010573
SZO574	ER7010574

\*SPECIAL ORDER GASKET - 3 to 6 week delivery

For up-to-date cross reference, go to [www.erparts.com](http://www.erparts.com)

# DOOR GASKETS

## Door Gasket Cross Reference

OEM Part #	ERP #
SZO575	ER7010575
SZO578	ER7010578
SZO583	ER7010583
SZO584	ER7010584
SZO592	ER7010592
SZO609	ER7010609
WHIRLPOOL	
0056811*	ER2188444A
10359708Q	ER10359708Q
10359709Q	ER10359709Q
1104911	ER4387565
1105497	ER2188450A
1105515	ER2188460A
1106173	ER2188445A
1106174	ER2188444A
1106175	ER2188445A
1106176	ER2188444A
1106177	ER2188456A
1106178	ER2188463A
1106179	ER2188456A
1106180	ER2188463A
1107638	ER4387590
1107639	ER2188461A
1109185	ER2188445A
1109186	ER2188444A
1109187	ER2188445A
1109188	ER2188444A
1110568	ER4387565
1110648	ER2188404A
1110649	ER2188433A
1110659	ER2188434A
1115314	ER2188404A
1116582	ER4387604
1116592	ER2188461A
1116734	ER4387604
1116735	ER2188461A
1118191	ER2188433A
1118192	ER2188434A
1119565	ER2188450A
1119568	ER2188460A
1122826	ER2188445A
1122827	ER2188444A
1122828	ER2188450A
1122829	ER2188456A

OEM Part #	ERP #
1122830	ER2188463A
1122831	ER2188460A
1124971	ER2188433A
1124972	ER2188434A
1125886	ER2188460A
1125887	ER2188450A
1125888	ER2188461A
1125889	ER4387604
1125924	ER2188458A
1125927	ER2188404A
1125928	ER2188434A
1125929	ER2188433A
1126756	ER2188450A
1126762	ER2188460A
1127256	ER2188458A
1127307	ER2188433A
1127308	ER2188434A
1127309	ER2188433A
1127310	ER2188434A
1128059	ER2188445A
1128060	ER2188456A
1128064	ER4387565
1129252	ER1129252
1129266	ER2188404A
12550101Q	ER12550101Q
12550111Q	ER12550111Q
12550112Q	ER12550112Q
12550115Q	ER12550115Q
2147024	ER2188458A
2148043	ER2188445A
2148044	ER2188456A
2148270	ER2188404A
2148565	ER2188450A
2148567	ER2188460A
2150117	ER2188444A
2150124	ER2188463A
2159057	ER2159057
2159061	ER2159061
2160436	ER2188458A
2160438	ER2188458A
2160883	ER2188458A
2162642	ER2188448A
2165383	ER2188462A
2166000	ER2188462A

OEM Part #	ERP #
2166001	ER2188462A
2177230	ER2188460A
2177232	ER2188458A
2177234	ER2188450A
2188404	ER2188404A
2188404A	ER2188404A
2188433	ER2188433A
2188433A	ER2188433A
2188434	ER2188434A
2188434A	ER2188434A
2188435A	ER2188435A
2188436A	ER2188436A
2188438A	ER2188438A
2188439A	ER4387626
2188442A*	ER2188442A*
2188444	ER2188444A
2188444A	ER2188444A
2188445	ER2188445A
2188445A	ER2188445A
2188447A	ER4387604
2188448	ER2188448A
2188448A	ER2188448A
2188450	ER2188450A
2188450A	ER2188450A
2188451A	ER4387590
2188456	ER2188456A
2188456A	ER2188456A
2188458	ER2188458A
2188458A	ER2188458A
2188460	ER2188460A
2188460A	ER2188460A
2188461	ER2188461A
2188461A	ER2188461A
2188462	ER2188462A
2188462A	ER2188462A
2188463	ER2188463A
2188463A	ER2188463A
2188464A	ER4387565
2191888	ER2188448A
2191889	ER2188462A
2262080	ER2262080
2262081	ER2262081
2319263T	ER2319263T
2319264T	ER2319264T

OEM Part #	ERP #
2319265T	ER2319265T
2319266T	ER2319266T
4339427	ER2188456A
4343266*	ER5303018791
4343449	ER4343449
4387565	ER4387565
4387566	ER2188456A
4387567	ER2188463A
4387568	ER2188462A
4387570	ER2188461A
4387572	ER2188460A
4387577	ER2188458A
4387580	ER2188458A
4387590	ER4387590
4387591	ER2188450A
4387592	ER2188450A
4387602	ER2188448A
4387603	ER4387604
4387604	ER4387604
4387605	ER4387604
4387607	ER2188446A
4387608	ER2188445A
4387609	ER2188444A
4387622	ER2188404A
4387623	ER2188404A
4387624	ER2188404A
4387626	ER4387626
4387634	ER2188434A
4387637	ER2188434A
4387638	ER2188433A
4387639	ER2188433A
4387641	ER2188433A
4387655	ER2188461A
4390530	ER4390530
510342*	ER510342*
510343*	ER510343*
510344*	ER510344*
510345*	ER510345*
528919*	ER528919*
61001979	ER61003999
61001980	ER61004002
61002006	ER61004006
61002024	ER61003998
61002054	ER61004007

\*SPECIAL ORDER GASKET - 3 to 6 week delivery

For up-to-date cross reference, go to [www.erparts.com](http://www.erparts.com)

# DOOR GASKETS

## Door Gasket Cross Reference

OEM Part #	ERP #
61002224	ER61004003
61003998	ER61003998
61003999	ER61003999
61004006	ER61004006
61004007	ER61004007
61004008	ER61004008
61004002	ER61004002
61004003	ER61004003
61004006	ER61004006
61004007	ER61004007
61004008	ER61004008
63442-6	ER700482
653209*	ER653209*
658998*	ER658998*
66199-1	ER700471
66199-2	ER700481
66199-3	ER700472
66199-5	ER700473
66199-6	ER700483
66199-8	ER700484
66929-1*	ER669291*
66929-14*	ER6692914*
66929-8*	ER669298*
70025-2	ER700252
70025-3	ER700253
70025-4	ER700254
70025-5	ER700255
70025-6	ER700256
700471	ER700471

OEM Part #	ERP #
700472	ER700472
700473	ER700473
700481	ER700481
700482	ER700482
700483	ER700483
700484	ER700484
831405*	ERD7092602Q*
836224	ER2188450A
836225	ER2188404A
836227	ER2188460A
836356	ER4387590
836357	ER2188461A
836507	ER2188461A
836508	ER2188460A
836510	ER4387590
836511	ER2188450A
838141*	ER838141*
848395	ER848395
876480*	ER876480*
876483*	ER876483*
935761	ER2188445A
937001	ER2188456A
939048	ER2188445A
939049	ER2188456A
939341	ER2188433A
939342	ER2188434A
939565	ER2188404A
939911	ER4387590
942268	ER2188445A

OEM Part #	ERP #
942271	ER2188456A
942287	ER2188445A
942289	ER2188456A
942299	ER4387590
942674	ER4387626
942903	ER2188461A
942931	ER2188450A
942933	ER2188460A
943116	ER2188404A
943220	ER2188404A
943981	ER2188450A
943982	ER2188460A
944457	ER2188433A
944470	ER2188434A
944948	ER4387565
945061	ER2188458A
945832	ER2188450A
945833	ER2188460A
946802	ER2188445A
946803	ER2188456A
946990	ER2188445A
946991	ER2188444A
946992	ER2188445A
946993	ER2188444A
946994	ER2188456A
946995	ER2188463A
946996	ER2188456A
946997	ER2188463A
9790369	ER2188448A

OEM Part #	ERP #
981092	ER4387626
983644	ER2188434A
986016	ER2188458A
986702	ER2188450A
986703	ER2188460A
986706	ER2188404A
986707	ER2188433A
987036	ER4387590
987037	ER2188461A
987151	ER4387590
987152	ER2188461A
987153	ER2188450A
987154	ER2188460A
992487	ER2188460A
992488	ER4387626
992582	ER1129252
D7092602Q*	ERD7092602Q*
D7092608Q*	ERD7092608Q*
D7092609Q*	ERD7092609Q*
D7251020Q	ERD7251020Q
D7605106Q*	ERD7605106Q*
D7605107Q	ERD7605107Q
D7605109Q	ERD7605109Q
D7605115Q	ERD7605115Q
D7605116Q	ERD7605116Q

\*SPECIAL ORDER GASKET - 3 to 6 week delivery

For up-to-date cross reference, go to [www.erparts.com](http://www.erparts.com)

# POWER STARTS

## POWER STARTS

### ERP's Power Starts for Refrigerators and Freezers

Designed for Refrigerators and Freezers, ERP's Power Start design replaces the relay, overload and start capacitor in one easy low cost package. Solid state current sensitive overload and PTC (Positive Temperature Coefficient) design offers universality, reliability, and proven performance. Additional boost applies safely to good systems or helps tired systems last longer. Easy mounting with either clip or screw.

#### Order No. ERP410

Power Start  
120 Volt  
1/4 and 1/3 HP



Replaces A-1 #WSX-4, Gemline #HS410, Supco #RC0410

#### Order No. ERP810

Power Start  
120 Volt  
1/12 and  
1/5 HP



Replaces A-1 #WSX-8, Gemline #HS810,  
Supco #RC0810

#### Order No. ERPU410

Powerstart Relay, Start Capacitor, Overload  
1/4 - 1/3 HP, 120V  
Totally pre-wired  
Will work with or without a run capacitor



Replaces Supco #URCO41

#### Order No. ERPU810

Powerstart Relay, Start Capacitor, Overload  
1/12 - 1/5 HP, 120V  
Totally pre-wired  
Will work with or without a run capacitor



Replaces Supco #URCO81

## POWER ASSISTS

### ERP's Power Assists for A/C and Heat Pumps

ERP's Power Assist kits for PSC single phase air conditioning and heat pump systems increases torque for hard starting conditions. Pre-Wired with "Piggy Back" terminals for easy wiring and installation. Solid state PTC (Positive Temperature Coefficient) design offers safe and reliable performance for a broad range of compressor HP and BTU

#### Order No. ERPP5

Power Assist  
120 V - 288 VAC  
1/2 - 5 HP  
4,000 - 60,000 BTU  
300% torque



Replaces A-1 #WSX-5, Gemline #HS600,  
Mars #32701, Supco #SSP5

#### Order No. ERPP6

Power Assist  
120 V - 288 VAC  
1/2 - 10 HP  
4,000 - 120,000 BTU  
500% torque



Replaces A-1 #WSX-6, Gemline #HS650,  
Mars #32702, Supco #SSP6

# RELAY/OVERLOADS

## ERP's Combination Relay/Overload

Solid state PTC relay with current sensitive overload makes ERP's Relay/Overload combination universal and reliable. Compact, non-positional and totally enclosed for easy placement and mounting. Same proven design used by OEMs to standardize multiple relays and overloads.

### Order No. ERIC13

120 V  
1/4 and 1/3 HP  
50/60 Hz



Replaces:  
Gemline #IC13  
Supco #R041,  
Whirlpool #819100, #819160

### Order No. ERIC15

120 V  
1/8 and 1/5 HP  
50/60 Hz



Replaces:  
Gemline #IC15  
Supco #R051,  
Whirlpool #819098, #819099

### Order No. ER12002782

Overload/Relay Kit



Replaces Whirlpool #12002782

### Order No. ER2225929

Overload/Relay

**NEW!**



Replaces Whirlpool #2225929

### Order No. ER61005518

Overload/Relay



Replaces Whirlpool #61005518

### Order No. ER61006022

Overload/Relay



Replaces Whirlpool #61006022

### Order No. ER4387913

Overload/Relay Kit



Replaces Whirlpool #4387913

### Order No. ER8201799

Overload/Relay Kit



Replaces Whirlpool #8201799

# OVERLOADS

Order No. ERWR09X10106



Replaces GE #WR09X10106

Order No. ERWR09X10107



Replaces GE #WR09X10107

Order No. ERWR07X10131



Replaces GE #WR07X10131,  
#WR08X10111

Order No. ERWR09X10124



Replaces GE #WR09X10124

Order No. ER12555902



Replaces Whirlpool #12555902

Order No. ER2188829

Used on 22 cubic ft.  
refrigerators  
Part of Whirlpool  
8201786 kit



Replaces Whirlpool #2188829

Order No. ER2188830

Used on 25 cubic  
ft. refrigerators and  
larger  
Part of Whirlpool  
8201786 kit



Replaces Whirlpool #2188830

Order No. ER5303270406

Nominal open 140°C  
Nominal close 61°C  
OEM EXACT



Replaces Electrolux #5303270406

Order No. ERWR8X122

Nominal open 130°C  
Nominal close 61°C  
OEM EXACT



Replaces GE #WR8X122

Order No. ER2187145

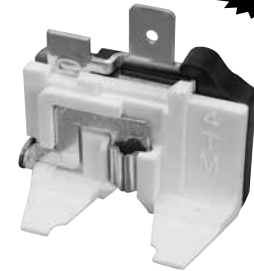

Replaces Whirlpool #2187145

Order No. ER4344040

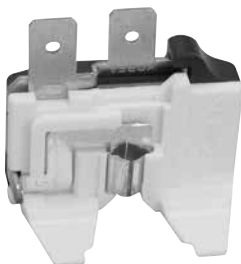

Replaces Whirlpool #4344040

Order No. ER61001898

Nominal open 125°C  
Nominal close 61°C  
OEM EXACT



Replaces Whirlpool #61001898

Order No. ER61006294



Replaces Whirlpool #61006294

REFRIGERATION



# CAPACITORS

Order No. ER5304464438

**NEW!**



Replaces Electrolux #5304464438

Order No. ER2169373

**NEW!**



Replaces Whirlpool #2169373

Order No. ER65889-4

**NEW!**



Replaces Whirlpool #65889-4

Order No. ER999509

**NEW!**



Replaces Whirlpool #999509

# PTC RELAYS

Exact Replacement PTC (Positive Temperature Coefficient) Relay for many OEM Models.  
Three terminals can be used with or without run capacitor (third terminal can be ignored if run capacitor is not present).

Order No. ERIC100

Replaces  
Electrolux #3204486, #216594300



Order No. ERIC102

Replaces  
Electrolux #3204486, #5303007173,  
GE #WR7X214, #WR7X194,  
#WR7X10055  
Whirlpool #66858-1, #68857-2,  
#10097202, #1108143, #61006293



Order No. ERIC103

Replaces  
GE #WR7X10011, #WR7X10031,  
Whirlpool #4356730



# REFRIGERATOR MISCELLANEOUS

Order No. ERWR71X2086

Refrigerator Wire Rack

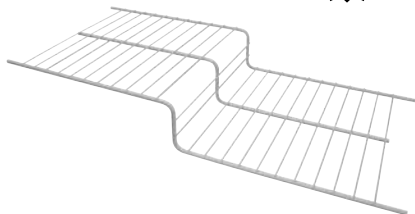

Replaces GE #WR71X2086

Order No. ER241993001

Crisper Support



Replaces Electrolux #241993001

Order No. ER5303288973

Crisper Support



Replaces Electrolux #5303288973

Order No. ERWR2X4901

Cam Riser Hinge



Replaces GE #WR2X4901

Order No. ERWR13X10020

Hinge Pin



Replaces GE #WR13X10020

Order No. ERWR2X9393

Heater Probe



Order No. ER819043

Heat Probe

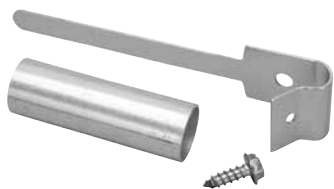

Order No. ERWR2X9391

Bulb Receptacle



Order No. ER61005604

Bulb Receptacle



Order No. ER18806

Light Switch



Order No. ERGA360

Horizontal refrigerator/freezer thermometer  
Hangs, stands or permanent  
Dual scale w/ 2° increments  
-40°F to 80°F (-40°C to 27°C)



Order No. ERTA47

Refrigeration pocket dial thermometer  
-40°F to 160°F



Order No. ERTA53

Hanging refrigerator thermometer  
-20°F to 80°F



# REFRIGERATOR MISCELLANEOUS

## Order No. 00985

### Wireless/digital refrigerator/freezer thermometer

- Audible & visual alarm when temps exceed pre-set minimum & maximum selection
- Temp range: -22°F to 104°F
- Main unit: 5-7/8"W x 2-3/8"H
- Sensors: 2"W x 4"H x 1-3/8"D
- Remote sensors include spring action clips for mounting inside freezer & refrigerator
- Main unit equipped with magnets to adhere to outside of unit



## Order No. 041000

### Surge Protector

- Protect valuable appliance from dangerous spikes and energy surges
- One outlet
- UL listed
- Surge energy rating 900 joules
- UL listed
- 120 volts, 15amp, 1800 watts



## Order No. ERTA302

### Digital Thermometer

- Switchable between °F and °C
- LCD display, waterproof housing
- Temperature: -40°F to 482°F (-40°C to 250°C)



## Order No. 301

### Valve Core Remover

- Provides effective removal and replacement of valve core from a service valve on a charged refrigeration system
- Unique gripper guarantees core removal every time
- Precision-machined ball valve
- Light-weight, chrome-plated brass cast
- Stainless steel torque driver
- Extended 65° angled design allows 33% larger flow area for faster recover and charging
- Dual o-rings for maximum sealing



## Order No. FRGKLEEN

### Refrigerator Odor Clean

- Cleans better than baking soda
- For refrigerator/freezers with cracks or breaks in plastic interiors
- Excellent for seasonally used refrigerators or after power outage



## Order No. DVDREF1

### Refrigerator Repair Basics Vol. 1



*Designed for beginning apprentices, do-it-yourselfers and those green techs; to give them the basic step by step procedures of how technicians might go about troubleshooting service calls in the home.*

### Problems

- 1) Refrigerator not cooling, no light and nothing works.
- 2) Refrigerator not cooling, only light works.
- 3) Not cooling, even though the compressor is running.
- 4) Doesn't cool enough, in one or both sections.
- 5) The compressor tries to start, buzzes, then clicks off.
- 6) The compressor clicks on & off before finally starting.
- 7) Refrigerator too cold & freezes the vegetables or milk.

## Order No. DVDREF2

### Refrigerator Repair Basics Vol. 2



### Problems

- 8) Ice cream is too hard or the milk freezes.
- 9) Cools OK but runs too much, or not cooling enough.
- 10) Runs too much and water droplets forming on the walls.
- 11) The door sticks when you try to open it.
- 12) The freezer is partly frozen, but the food section is warm.
- 13) The cabinet light doesn't light when the door is open.
- 14) There's an odor of spoiled food in the kitchen, near the frig.
- 15) There's a puddle of water near the frig on the floor.
- 16) Something electrical smells like its burning.
- 17) Something is making noise in the frig.
- 18) The cold control is stuck - or its knob is hard to turn.
- 19) Defrost timer is defective - testing & advancing the timer.
- 20) A Frost free doesn't cool - should we repair it or junk it.

## Order No. B47C

### Refrigerator Condenser Coil Brush

- Loosens dirt & dust off coils
- 26" long



**Also available in Spanish, order Part No. DVDREF1-S and DVDREF2-S**

*(Special order - 3 week lead time)*

# ADHESIVES

## Order No. 302U

- Plastic Surgery  
 • Drip/Clog proof applicator  
 • "Bites" into plastic  
 • Bonds: acrylic, nylon, fiberglass, plexiglass®, polycarbonate, polyester, PVC, urethane



## Order No. 304D

- Plastic Surgery Super Gel  
 • "Bites" into plastic  
 • Bonds: acrylic, nylon, fiberglass, plexiglass®, polycarbonate, polyester, PVC, urethane



## Order No. 308D

- Super Glue  
 • 10 gram size  
 • Bonds: metal, wood, glass, rubber, plastics  
 • Industrial strength  
 • Will not dry out  
 • Drip proof  
 • Clog proof



## Order No. 325D

- Super Glue (2 pack)  
 • 2 tubes @ 3 grams each  
 • Bonds: most surfaces  
 • Reusable twist-off cap



## Order No. SUP-2B

- Super Glue (2 pack)  
 • 2 tubes @ .07 oz. each  
 • Bonds: most surfaces  
 • Strong, fast, permanent



## Order No. MS-H

- All Purpose Spray Adhesive  
 • 11 oz. can  
 • Permanent bond: spray both sides  
 • Repositionable bond: spray 1 side  
 • Bonds: paper, fabrics, leather, cardboard, foil, foam, metal, wood, plastic, rubber, cork, felt



## Order No. 81504

- Extra Time Epoxy  
 • .85 fl. oz.  
 • Sets in 60 min.  
 • Syringe type applicator applies resin & hardener  
 • Bonds: wood, metal, glass ceramic, plastic, tile



## Order No. 80242

- Clear Silicone Sealant  
 • 1.5 oz.  
 • Sets in 2 hours  
 • Bonds: tile, ceramic, porcelain, metal, glass, paint, wood, most plastics



## Order No. 66BR

- Clear RTV Silicone  
 • 3 oz.  
 • Interior/exterior use  
 • Includes a taper nozzle



## Order No. 390D

- Threadlocker Red  
 • .38 oz.  
 • Drip/clog proof  
 • One-of-kind applicator



## Order No. 24200

- Threadlocker Blue  
 • .20 oz.  
 • Prevents threaded fasteners from loosening  
 • Service removable



## Order No. 82361

- Tite'N for Bolts  
 • 3.2 oz.  
 • Prevents bolts from vibrating loose



## Order No. 68571

- Teflon Tape  
 • 1/2" x 520"  
 • Mil psec T-27730A



## Order No. 7535304360

- Vinyl Electrical Tape  
 • 3/4" x 60" x .007"  
 • Not to exceed 600V and 176°F (80°C)  
 • UL & SA approved



## Order No. ERBPS22

- Seal All  
 • 1 fl. oz.  
 • Contact adhesive and sealant  
 • Quick drying  
 • Gas & oil resistant



## Order No. HU-4

- Double-Sided Mounting Tape  
 • 3/4" x 60"  
 • Indoor use only  
 • Semi-permanent



SERVICE AIDS AND TOOLS

# CLEANERS

## Order No. 77801

- Condensate Line Cleaner
- 4.5 oz.
  - For A/C units and refrigerator drains
  - Includes adapter hose



## Order No. WCOIL

- A/C Coil Cleaner
- 20 oz.
  - Professional strength
  - For A/C & heat pump coils
  - Biodegradable
  - Increases efficiency



## Order No. WCHARGE

- Filter Charger
- 14 oz.
  - Adhesive spray that makes disposable filters more effective
  - Will charge up to 100 disposable filters



## Order No. 3000PT Order No. 3500PT

- Precision Contact Cleaner
- Restores electrical continuity of contacts & cleans surrounding area
  - No residue, safe on plastics & metals
  - Apply on: contacts, relays, connectors, sockets, motors circuit breakers, switches

5.5 oz.

13.25 oz.



## Order No. 7000PT

- Value Duster
- 10 oz.
  - Removes dry contaminants from electronic equipment
  - 70 psi, safe on plastics, no residue



## Order No. 10140WD

- High Performance Penetrant Spray
- 11 oz.
  - Prevents rust and corrosion
  - Removes grease and grime
  - Loosens rusted or stuck parts



## Order No. 1825

- Stainless Steel Magic
- 22 oz.
  - Cleans & shines
  - No scratching or water spotting
  - Leaves protective barrier



## Order No. 1860

- Stainless Steel Magic
- 17 oz.
  - Streak-free shine
  - Prevents fingerprints



## Order No. 1879

- Kitchen Grease Cleaner
- 14 oz.
  - Fast, strong, safe for surfaces
  - Grease cutting foam
  - Great for sealed stone & granite countertops, backsplashes, stove tops, microwaves, etc.

**NEW!**



## Order No. 50333025

- Stainless Steel Magic Wipes
- 35 wipes
  - All-in-one cleaner/polisher
  - Non-abrasive, streak-free
  - Leaves a protective barrier



## Order No. 50332015

- Countertop Magic
- 13 oz.
  - For use on all countertop surfaces
  - Restores luster
  - Cleans and polishes



## Order No. GG12 Order No. GZ92

- Goo Gone
- Removes: sticky, gummy, greasy, gooey problems

8 oz.

1 quart



## Order No. GGHS12

- Goo Gone Spray Gel
- 12 oz.
  - Removes: sticky, gummy, greasy, gooey problems
  - Safe for hands and fabrics
  - 100% organic, biodegradable



## Order No. GG66

- Grease Cutting, Multi-Purpose Cleaner
- 24 oz.
  - Environmentally friendly
  - Indoor/outdoor use



## Order No. 5011509

- Grill Cleaner
- 24 oz.
  - Removes grease, carbon & baked on deposits
  - Safe to use on: cast-iron, stainless, baked-on porcelain, enamel, cooking grates & drip pans





# LUBRICANTS

**Order No. 10011WD** 11 oz. with Smart Straw  
**Order No. 10124WD** 18 oz. with Big Blast Head

- WD-40
- Smart Straw for spray or stream
  - Big Blast for wide-area spray
  - Cleans/protects
  - Dries out moisture
  - Prevents rust

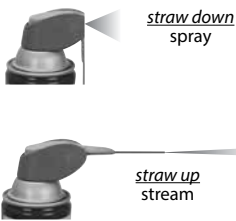

**Order No. 10142WD**

- White Lithium Grease
- 10.25 oz.
  - Water/heat resistant
  - Long lasting
  - Will not splatter, melt, run, wash off or freeze



**Order No. ERZS75**

- Zoom Spout Oiler
- 4 oz.
  - All-purpose turbine oil
  - Spout applicator telescopes to 14"



**Order No. WG-60**

- White Lithium Grease
- 2 oz.
  - Multi-purpose lubricant
  - Resists heat & moisture



**Order No. 69375**

- Lubriplate
- 1-3/4 oz. tube
  - Multi-purpose lubricant
  - Prevents wear/corrosion



**Order No. 116DA**

- Silicone Spray
- 10.25 oz.
  - Lubricates, seals, protects



**Order No. 133AR**

- Anti-Seize Lubricant
- 1 oz.
  - Made in the USA
  - Withstands high temps
  - Prevents seizing/corrosion



**Order No. S00510**

- Food Grade Economy Silicone Lubricant
- 16 oz.
  - USDA H-1 rated
  - Prevents sticking without transferring to end products
  - Meets FDA regulations
  - Used on: guide rails, knives, mixers, food racks



**Order No. TF22020**

- Tri-Flow Food Grade Grease with Teflon
- 11.25 oz. can
  - USDA H-1 rated
  - Durable, long lasting
  - Waterproof
  - Nonstaining
  - Kosher approved





# SUPPLIES

## Order No. 4ARMC

### Order No. 4ARMCTRC (5-piece display)

#### Forearm Forklift

- Innovative leverage lifting tool
- Makes items feel 66% lighter
- Helps stabilize furniture when carrying
- Each pair can lift up to 600 lbs.



4ARMC



4ARMCTRC - 5 piece counter display



## Order No. 85-011

#### Pack-N-Roll

- Open size: 14"H x 15-5/8"W x 12-3/4" D
- Closed size: 16"H x 17"W x 3"D
- Handle extends to 23"
- Holds up to 80 lbs.



## Order No. SHUBEE

#### Shubee Shoe Covers

- 50 pair per box - blue
- Put on over shoes or work boots to keep floors & carpets clean
- Fits up to size 16 boot
- Other colors available, special order charges apply



## Order No. H-214

#### Swat Bee & Wasp Killer

- 14 oz.
- Kills wasps, bees & hornets on contact
- 20 ft. stream



## Order No. B42C

#### Coffee Pot Brush

**NEW!**

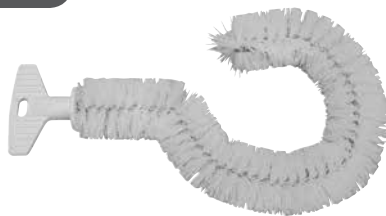

## Order No. B108C

#### Wide Style Grill Brush

**NEW!**



# SUPPLIES

**Order No. 1125** (white glaze)

**Order No. 1126** (white)

**Order No. 1438** (almond)

**Order No. 1440** (bisque)

**Order No. 1999** (black)

Porcelain Touch-Up Paint

- High temp. appliance
- For use up to 400° F
- Will not chip or crack



**Order No. 98QB0301** (pearl/off-white)

**Order No. 98QB0303** (snow/bright white)

Microwave Oven Cavity Touch-up Paint

- 1/2 fl. oz. w/ brush
- Formulated specifically for use in microwaves



**Order No. 1455**

White Porcelain Filler & Repair

- For high temperature use
- Max. 400° F



**Order No. 98QB0300** (pearl/off-white)

**Order No. 98QB0302** (snow/bright white)

Microwave Oven Cavity Paint

- 6 oz. spray
- Formulated specifically for use in microwaves



**Order No. 4245** (almond)

**Order No. 4250** (appliance white)

Appliance Paint

- 12 oz.
- Leaves a hard enamel finish
- Fade resistant



**Order No. AP177**

Bisque/Biscuit Appliance Paint

- 12 oz.
- Leaves a hard enamel finish
- Fade resistant



**Order No. FG-AR11**

Spray-On Stainless Steel

- 11 oz.
- Makes ordinary items look like stainless steel
- Indoor/outdoor durability



**Order No. 9968QL**

Clip-On LED Flashlight

- Clips to bill of hat or on glasses
- Weighs 1 oz.
- 100 hr. battery life (batteries included)
- 360° swivel, 90° tilt



**Order No. DA76570**

Magnetic Pick-Up Light

- Telescopes to 22" long
- 5 LED lights
- 1 magnet on end to pick up objects



# TOOLS

## Order No. 79770

### 9-Piece Security Tee Star (TORX®)

- All 1" bits store in handle

#### Included bits:

T7, T8, T9, T10, T15, T20, T25, T30, TORX®



## Order No. DA86370 (SAB444)

### Select-A-Bit Security Screwdriver

- Use with security fasteners

- Includes 14 security & 2 standard tips on eight 3" long double-ended bits

#### DA86370 bits:

#2 Phillips®, 7/32" slotted  
1, 2 Roberts  
10, 15, 20, 25 TORX®  
1/8", 9/64", 5/32", 3/16" Hex  
4, 6, 8, 10 Spanner



## Order No. 83304

### 7-Piece Security Tee-Star

- Rotating plastic case
- Magnetic bit holder 2-7/8"

#### Included bits:

T10, T15, T20, T25, T27, T30, TORX®



## Order No. 73238 10 pc. set

## Order No. 73239 5 pc. set

### Security Tee Star (TORX®) Set

#### 73238:

T8, T9, T10, T15, T20, T25, T27, T30, T35, T40

#### 73239:

T8, T9, T10, T15, T25



## Order No. 73276

### 4-Piece Triple-Wing Bit Set

- 1/4" hex 1" long, ISOMAX® replacement security bits
- Fits #1, #2, #3, #4 Tri-Wing screws



## Order No. 32025

### 6-in-1 Full Size Screwdriver

- 12 pc. display
- Colors include black, blue, green, red

#### Included bits:

#1, #2, Phillips®  
4-5, 8-10 slotted  
1/4", 5/16" nut setters



## Order No. 82774

### 10-in-1 Screwdriver with Magnetic Pickup

- Silent ratcheting feature

#### Included bits:

#1, #2, #3 Phillips®  
R2 Robertson®, T15 TORX®,  
4-5, 8-10 slotted



## Order No. 88777

### 6-in-1 Stubby Screwdriver

#### Included bits (2 w/ each driver):

Two 1-1/2" long, 1/4" Hex Twinbits  
with these ends:  
#1, #2 Phillips® & 4-5, 8-10 slotted  
Use handle as 5/16" nut setter  
Use 1/4" hex tube as  
1/4" nut setter



Sold in 12 pc display

## Order No. DA76440 (ELB811) standard

## Order No. DA76450 (ELB811) security

### 6-in-1 High Torq Driver

- Ergonomic grip
- Chrome-plated nosepiece



#### Standard bits:

#1, #2 Phillips®  
3/16" slotted  
1/4", 5/16" nut drivers

#### Security bits:

15, 20, 25, 30 TORX®  
1/4", 5/16" nut drivers

## Order No. DA75610 red 1/4"

## Order No. DA75620 yellow 5/16"

## Order No. DA75630 blue 3/8"

### Adjustable Length Nut Drivers

- Shafts adjust from 3" to 6"
- Magnetic ends
- Color coded handles

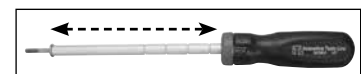

# TOOLS

## Order No. DA76370 (ELB717)

### Nut Driver Set

- Hollow shaft with deep sockets

#### Included SAE drivers:

3/16", 1/4", 5/16", 11/32", 3/8", 7/16", 1/2"



## Order No. DA78200

### Element Removal Wrench

- For water heater elements with 1-1/2" nut



## Order No. SAB601 (standard)

## Order No. DA86420 (12 pc display)

## Order No. SAB601M (metric)

### 4-in-1 Nut Driver Multi Socket

- Telescoping ends provide two socket sizes at each end

#### Included sizes:

standard: 1/4", 5/16", 3/8", 7/16" or metric: 7mm, 8mm, 10mm, 13mm



## Order No. 73611

### 11" Flex-A-Bit

- Used in high-speed tools
- 90° flexibility
- Industrial duty flexible bit holder
- 1/4" male x 1/4" female hex ends



## Order No. KTD01C

### Magnum Tip Hand Drill Set

- 13-pc set
- Includes drill and 12 bits
- Small bit sizes 52-74
- Bits are indexed by number and decimal dia.
- Great for drilling or cleaning orifices



## Order No. KTDC

### Hand Drill Set

- 13-pc set
- Includes drill and 12 bits
- Small bit sizes 52-74
- Bits store in handle
- Great for drilling or cleaning orifices



## Order No. W1343

### 25-Piece Quick Change Drill & Bit Set

#### Includes:

- 1 quick change holder, 3 SAE nut drivers
- 12 assorted 2" long bits (Phillips®, slotted, square)
- Two 6" long chrome bits (Phillips®, slotted)
- 7 drill bits with hex shanks
- 1 storage case



## Order No. DA76070 (ELB250) 1.25" cutter, red

## Order No. DA76080 (ELB251) 2" cutter, black

### Wire Strippers

- No stripping holes to locate
- This tool self-adjusts to wire sizes
- DA76070 for 26 to 14 AWG
- DA76080 for 14 to 10 AWG

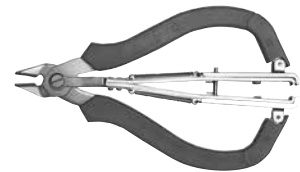

## Order No. DA76090 (ELB301)

### 10" Crimping Pliers

- Oversized cross section for heavy-duty jaws
- Bright, 2 colored, cushioned grip handles
- Professional quality materials/construction



## Order No. DA76110 (ELB303)

### 8" Long Nose Pliers

- Oversized cross section for heavy-duty jaws
- Bright, 2 colored, cushioned grip handles
- Professional quality materials/construction



# TOOLS

## Order No. DA76150 (ELB320)

### Extended, Long-Nose Pliers

- Has 11" reach and choice of nose angles
- Professional quality
- Bright, 2 colored, cushioned grip handles



## Order No. DA76190 (ELB340)

### Dual Snap Ring Pliers

- Removes internal & external snap rings
- Spring loaded
- Cushioned handles



## Order No. DA84000 (RC1216)

### Pry-Angle Appliance Leveling Tool

- Claw head will lock into 5 positions: 180° (straight), 155°, 130°, 105°, 80°
- 16" long
- Lifts appliance to adjust leveling legs
- Rated at 300 ft/lbs torque
- Has thumb lever locking mechanism



## Order No. DA76470 (ELB910)

### Telescoping LED Pick-Up and Mirror

- 3 pc set= magnet pick-up, mirror & case
- Pick-up telescopes to 26" collapses to 7" and features a bright LED on end
- Mirror (2.25" dia.) telescopes to 36", collapses to 8"

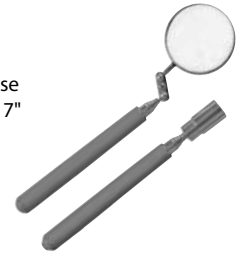

## Order No. DA84150 (RC5010)

### Mini Jack Knife

- Includes 10 blades
- Folds to 2.5"
- Quick, no tool blade changes



## Order No. DA84140 (RC5003)

### Jack Knife

- Includes pouch & 5 blades
- Folds to 3.5"
- Quick, one step blade changes



## Order No. DA84200

### Jack Knife

- Uses double-notched standard & contractor-quality blades
- Simple, quick blade change out



## Order No. 590441

### Wire Strippers



## Order No. DA76410

### Ergonomic Wire Stripper

- For gauges 10-20 AWG
- For 6-32, 8-32 screws



## Order No. ERVT

### Voltage Detector

- Determines presence or absence of 100-1000 volt AC
- Includes AAA batteries
- CAT III (UL)



**NEW!**



# TOOLS

## Order No. ERTB1185

Circuit tester  
Detects the presence of voltage  
90 to 550 V range



## Order No. 580500

Spark Key  
• Safe reliable way to light a torch  
• Lightweight, durable,  
water-resistant, no-roll design  
• Will strike over 100,000 times



## Order No. ERTB301

Swage tool  
• 3/16" - 5/8" O.D.



## Order No. ERTB300

Swage set  
1/4", 5/16", 3/8", 1/2", 5/8"



## Order No. ERTM802

Digital clamp meter  
• Maximum opening: 1-9/16"  
• Current measurement protection up to 800A  
• Data hold function capability for every reading  
• Large 1/2" high, 3-1/2" wide LCD display  
• Weight: 9 ounces  
• Maximum reading of 1999  
• Dimensions: 8-3/16" x 1-7/16"



Functions:	Ranges:
AC current (AC)	20A, 200A, 600A
AC voltage (ACV)	200V, 750V
Resistance (Ω)	2KΩ

## Order No. ERDMWT

Digital Multimeter



## Order No. ERTC105

10 Piece Jumper Set  
• 18" leads  
• 5 colors:  
red, green, blue, yellow, white

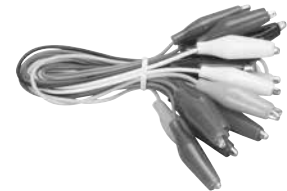

## Order No. E RTP

Temperature Probe  
• 40" lead wire





# MOTORS

## 550 SERIES FOR KITCHEN VENT HOODS

ERP's 550 Series vent hood motors are industry proven and specifically designed for application in popular Nutone hoods. All models are rated at 120 volts/60 Htz. UL Recognized.

### Order No. ERM550

0.55 amps, 3000 rpm, CCW rotation  
Shaft: 1-3/4" L x 7/32" dia.  
Stack thickness: 1/2"  
Has 120V plug, includes fan blade



Replaces: C65878/VFM-100, 65878000

### Order No. ERM551

1.28/.8 amps, 3000/1550 rpm, CW rotation  
Shaft: 1-7/16" L x 7/32" dia.  
Stack thickness: 7/8"  
Has 2 speed plug



Replaces: C52367/VFM-101, 52367000

### Order No. ERM552

0.9 amps, 3000 rpm, CCW rotation  
Shaft: 1-1/4" L x 7/32" dia.  
Stack thickness: 3/4"  
Has 120V plug



Replaces: C63675/VFM-103, 63675000

### Order No. ERM553

0.8 amps, 3000 rpm, CCW rotation  
Shaft: 1-1-3/4" L x 7/32" dia.  
Stack thickness: 3/4"  
Has eyelets on wire ends



Replaces: C66582/VFM-104, 66582000, 57769000

### Order No. ERM554

1.2/.8 amps  
3000/1550 rpm, CCW rotation  
Shaft: 1-7/16" L x 7/32" dia.  
Stack thickness: 7/8"  
Has 2 speed plug



Replaces: C27987/VFM-105, 27987000

### Order No. ERM555

0.55 amps  
3000 rpm, CCW rotation  
Shaft: 2-3/8" L x 7/32" dia.  
Stack thickness: 5/8"  
Has 120V plug



Replaces: C68627/VFM-106, 68627000

## REVERSE MOUNTING INSTRUCTIONS

ERP's direct replacement Broan motors make motor replacement easy and affordable by utilizing our innovative reversible bearing design.

**NOTE:** Make sure to only reverse the bracket and not the motor rotor shaft assembly. Reversing the rotor shaft assembly will result in rotation change of the motor reversal of air flow.

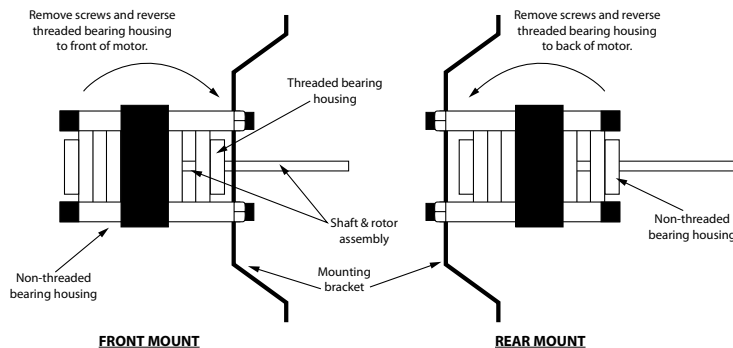

### Order No. ER97012248

Kitchen Vent Motor

Direct and Universal 2-speed replacement for...

Broan #97007966, #97011220, #99080365, #99080410, #99080492, GE #WB26X5122, Nutone #K4419000  
Broan #97011222 (reverse mounting to rear of motor)  
Broan #99080218 & Nutone #K4414000 (use old motor mounting bracket with new blade)

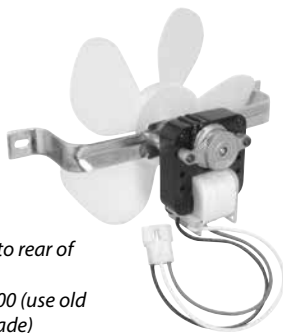

### Order No. ER97012038

Bath Vent Motor

Direct and Universal replacement for...

Broan #97012038  
Broan #97012041, #9701204 (reverse mounting to front of motor)  
Broan #97012028 (use existing mounting plate)



# MOTORS

ERP's 670 Series Motors feature versatile designs for application in refrigerators, freezers, condenser fans, vending machines, vent hoods, exhaust fans and ventilators. All motors are industry proven, impedance protected and UL Recognized. Models available with both bearing and bushing designs. Motor kits: ERM670, ERM672 and ERM675 include fan blade(s), mounting bracket, hub adapters and shaft adapters to convert to 1/4" or 5/16" shafts.

## Order No. ERM670

Utility Motor  
60Hz, 120V, 0.55 amps  
3000 rpm  
CW/CCW rotation  
Shaft: 1-1/4" L x 3/16" dia.  
Stack thickness: 5/8"  
Has bushings

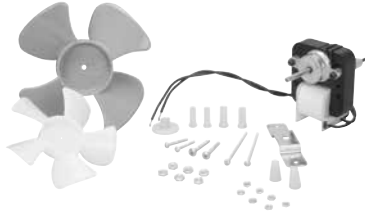

## Order No. ERM671

Utility Motor  
60Hz, 120V, 0.55 amps  
3000 rpm  
CW/CCW rotation  
Shaft: 1-1/4" L x 3/16" dia.  
Stack thickness: 5/8"  
Has bushings



## Order No. ERM672

Utility Motor  
50/60Hz, 240V, .45/.22 amps  
3000 rpm  
CW/CCW rotation  
Shaft: 1-1/4" L x 3/16" dia.  
Stack thickness: 5/8"  
Has bushings

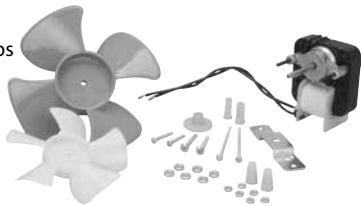

## Order No. ERM673

Utility Motor  
60Hz, 120V, .55/.34 amps  
3000/1550 rpm  
CW/CCW rotation  
Shaft: 1-1/4" L x 3/16" dia.  
Stack thickness: 5/8"  
Has bushings

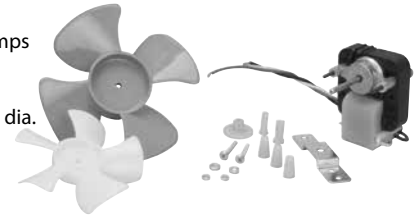

## Order No. ERM674

Utility Motor  
60Hz, 120V, 0.55 amps  
3000 rpm  
CW/CCW rotation  
Shaft: 1-1/4" L x 3/16" dia.  
Stack thickness: 5/8"  
Has bushings

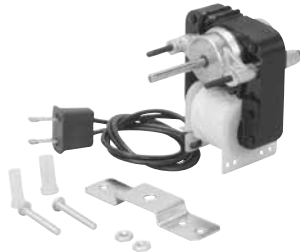

## Order No. ERM676

Utility Motor  
60Hz, 120V, 0.5 amps  
3000 rpm  
CW/CCW rotation  
Shaft: 1-1/4" L x 3/16" dia.  
Stack thickness: 7/8"  
Has bushings

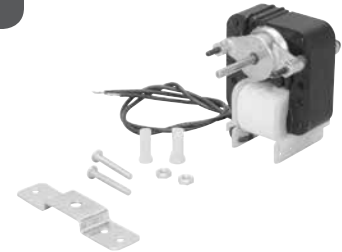

## Order No. ERM678

Utility Motor  
60Hz, 120V, 0.55 amps  
3000 rpm  
CW/CCW rotation  
Shaft: 1-1/2" L x 3/16" dia.  
Stack thickness: 1/2"  
Has bushings



## Order No. ERM680

Utility Motor  
60Hz, 120V, 0.9 amps  
3000 rpm  
CW/CCW rotation  
Shaft: 1-1/2" L x 3/16" dia.  
Stack thickness: 1-1/8"  
Has bushings



## Order No. ERM681

Utility Motor  
60Hz, 120V, .82/.21 amps  
3000/1550 rpm  
CW/CCW rotation  
Shaft: 1-3/8" L x 3/16" dia.  
Stack thickness: 5/8"  
Has bushings



## Order No. ERM682

Utility Motor  
60Hz, 120V, .60/.36 amps  
3000/1550 rpm  
CW/CCW rotation  
Shaft: 1-3/8" L x 3/16" dia.  
Stack thickness: 1"  
Has bushings

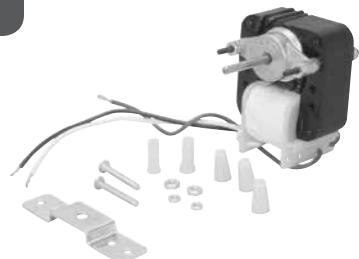

# MOTORS

## Order No. ERM683

Utility Motor  
60Hz, 240V, .25 amps  
3000 rpm  
CW/CCW rotation  
Shaft: 1-1/4" L x 3/16" dia.  
Stack thickness: 7/8"  
Has bushings



## Order No. ERM686

Ball Bearing Utility Motor  
60Hz, 120V, 0.41 amps, 3000 rpm  
CW/CCW rotation, Has bearings  
Shaft: 1-1/4" L x 3/16" dia., stack thickness: 5/8"

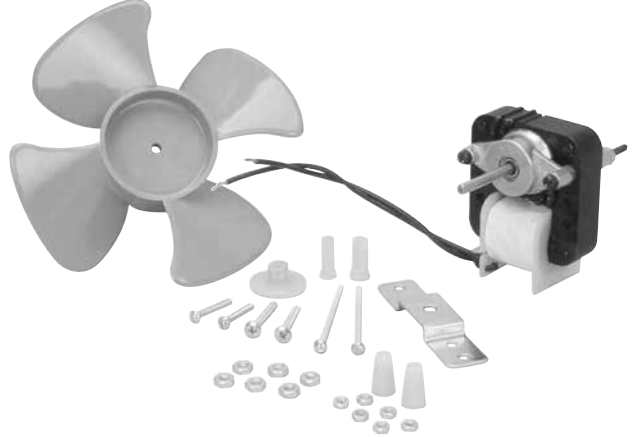

## Order No. ERM687

Utility Motor  
50/60Hz, 120/240V, 1.6/.80-1.0/.52 amps, 3000 rpm  
CW/CCW rotation, Has bearings  
Shaft: 2-3/8" L x 3/16" dia., stack thickness: 1-1/8"

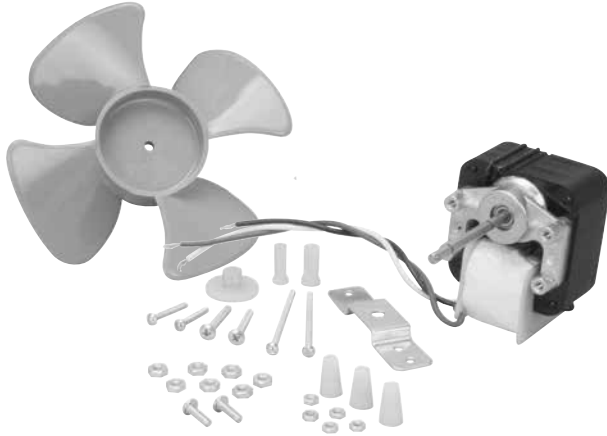

## Order No. ERM688

Ball Bearing Utility Motor  
60Hz, 120V, 0.86 amps  
3000 rpm  
CW/CCW rotation  
Shaft: 1-1/2" L x 3/16" dia.  
Stack thickness: 1-1/8"  
Has bearings



## Order No. ER99020272

Fan Blade  
6-1/2" width, CW Rotation

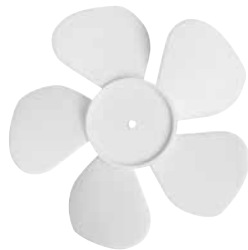

## Order No. ER600BLADE

Fan Blade  
5-1/4" width, CCW Rotation  
Fan blade will fit most 600 Series motors

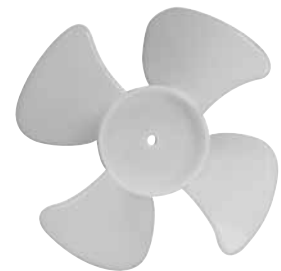

## Order No. ER99080166

Vent Hood Motor  
1.1 amps, 3000 rpm  
CCW rotation  
Shaft: 1-1/4" L x 7/32" dia.  
Stack thickness: 7/8"  
Has 120V plug

**NEW!**



Replaces Broan #99080166

## Order No. ER99080218

Vent Hood Motor  
1.0 amps, 3000 rpm  
CCW rotation  
Shaft: 1-3/8" L x 7/32" dia.  
Stack thickness: 7/8"  
Has 2 speed plug

**NEW!**

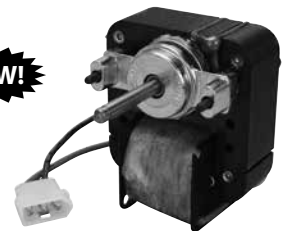

Replaces Broan #99080218

# FURNACE IGNITERS

Silicon Carbide Furnace Igniters are made in USA and  approved

## Ceramic Block Types

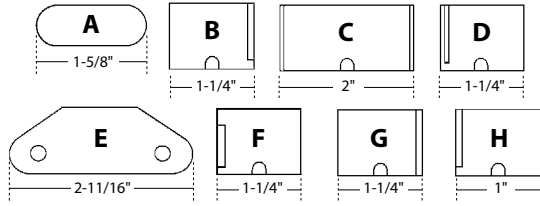

## Terminal Block Types

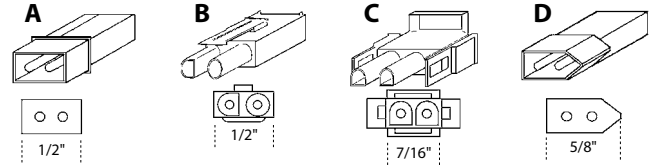

### Order No. ER1090

Ceramic block: H  
Terminal block: stripped ends  
Kit includes: 3 brackets, wire sleeving, screw and wire nuts

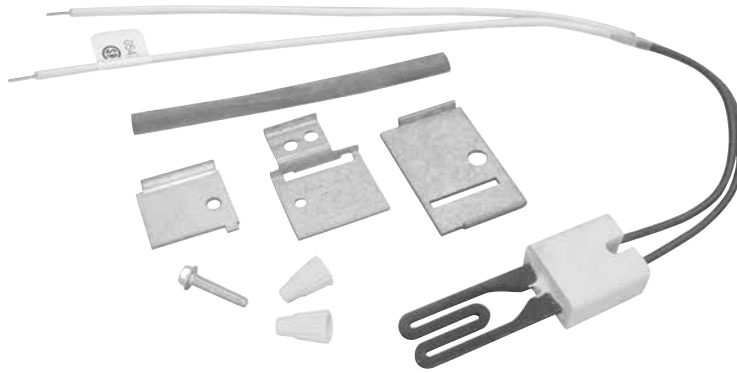

**UNIVERSAL IGNITER** - Fits: Armstrong #38322B001; Carrier #LH33ZS001, #LH33ZS002; ERP #ER1402, #ER1403, #ER1405, #ER1407, #ER1408, #ER1409, #ER1410, #ER1411; Norton #201D, #201N, #201W, #271D, #271M, #271N, #271W; Rheem #62-22441-01, #62-22868-82, #62-22868-92; Robertshaw #41-402, #41-403, #41-405, #41-407, #41-408, #41-409, #41-410, #41-411; Trane #340039P01, #B138196P01, #B144676P01, #B340039P01, #IGN23, #IGN26, #IGN30; White Rodgers #767A-361; York #025-27766-000, #025-27774-000, #025-29043-000

### Order No. ER1090N

Ceramic block: H  
Terminal block: stripped ends  
Kit includes: 3 brackets, wire sleeving, screw and wire nuts

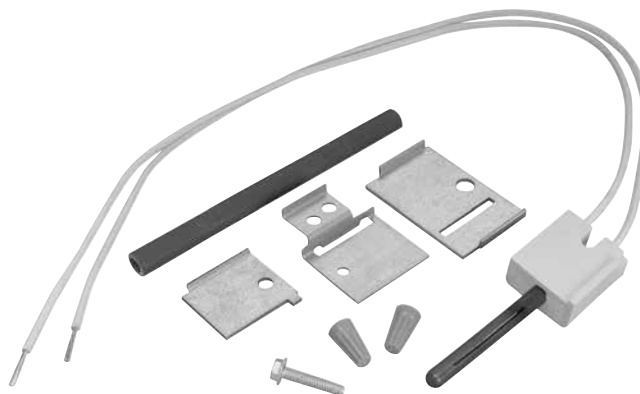

**UNIVERSAL IGNITER** - Fits: Armstrong #38322B001; Carrier #LH33ZS001, #LH33ZS002; ERP #ER1402, #ER1403, #ER1405, #ER1407, #ER1408, #ER1409, #ER1410, #ER1411; Norton #201D, #201N, #201W, #271D, #271M, #271N, #271W; Rheem #62-22441-01, #62-22868-82, #62-22868-92; Robertshaw #41-402, #41-403, #41-405, #41-407, #41-408, #41-409, #41-410, #41-411; Trane #340039P01, #B138196P01, #B144676P01, #B340039P01, #IGN23, #IGN26, #IGN30; White Rodgers #767A-361; York #025-27766-000, #025-27774-000, #025-29043-000

# FURNACE IGNITERS

Silicon Carbide Furnace Igniters are made in USA and  approved

## Order No. ERB1401018S

Ceramic block: H  
Terminal block: C



Fits: Goodman #B1401018S

## Order No. ER02532625000

Ceramic block: B  
Terminal block: B



Fits: York #025-32625-000

## Order No. ER1401

Ceramic block: A  
Terminal block: A



Fits: Amana #10041601, #B1336102,  
#D99182; Norton #201A, #271A;  
Robertshaw #41-401;  
White Rodgers #767A-309, #767A-356

## Order No. ER1401N

Ceramic block: A  
Terminal block: A



Fits: Amana #10041601, #B1336102,  
#D99182; Norton #201A, #271A;  
Robertshaw #41-401;  
White Rodgers #767A-309, #767A-356

## Order No. ER1402

Ceramic block: B  
Terminal block: stripped ends



Fits: Armstrong #38322B001;  
Norton #201D, #201N, #201W,  
#271N, #271W; Rheem #62-22441-01;  
Robertshaw #41-402;  
Trane #340039P01, #IGN23

## Order No. ER1402N

Ceramic block: B  
Terminal block: stripped ends



Fits: Armstrong #38322B001;  
Norton #201D, #201N, #201W, #271N,  
#271W; Rheem #62-22441-01;  
Robertshaw #41-402;  
Trane #340039P01, #IGN23

## Order No. ER1403

Ceramic block: C  
Terminal block: stripped ends

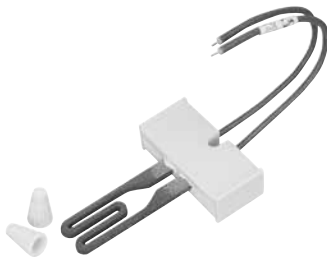

Fits: Norton #271, #271M;  
Robertshaw #41-403;  
Trane #B138196P01,  
#IGN26, #IGN30

## Order No. ER1403N

Ceramic block: C  
Terminal block: stripped ends

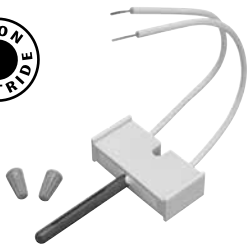

Fits: Norton #271, #271M;  
Robertshaw #41-403;  
Trane #B138196P01, #IGN26, #IGN30

## Order No. ER1404N

Ceramic block: C  
Terminal block: stripped ends

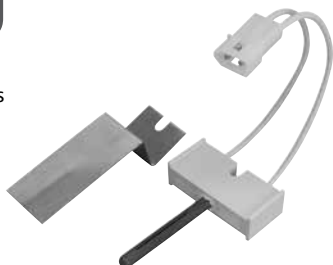

Fits: Robertshaw #41-404

## Order No. ER1405

Ceramic block: D  
Terminal block: stripped ends



Fits: Norton #201D, #271D;  
Robertshaw #41-405;  
White Rodgers #767A-361;  
York #025-27766-000,  
#025-27774-000, #025-29043-000



# FURNACE IGNITERS

Silicon Carbide Furnace Igniters are made in USA and  approved

## Order No. ER1405N

Ceramic block: D  
Terminal block: stripped ends

*Fits: Norton #201D, #271D;  
Robertshaw #41-405;  
White Rodgers #767A-361;  
York #025-27766-000,  
#025-27774-000, #025-29043-000*

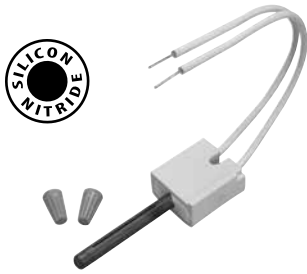

## Order No. ER1406

Ceramic block: E  
Terminal block: stripped ends

*Fits: Lochinvar #PLT2400;  
Norton #271Y; Robertshaw #41-406*



## Order No. ER1406N

Ceramic block: E  
Terminal block: stripped ends

*Fits: Lochinvar #PLT2400;  
Norton #271Y; Robertshaw #41-406*



## Order No. ER1407

Ceramic block: C  
Terminal block: B

*Fits: Norton #271;  
Robertshaw #41-407;  
Trane #B144676P02*



## Order No. ER1407N

Ceramic block: C  
Terminal block: B

*Fits: Norton #271;  
Robertshaw #41-407;  
Trane #B144676P02*



## Order No. ER1408

Ceramic block: B  
Terminal block: C

*Fits: Norton #271N;  
Rheem #62-22868-92;  
Robertshaw #41-408;  
Trane #B340039P01;  
White Rodgers #767A-372*



## Order No. ER1408N

Ceramic block: B  
Terminal block: C

*Fits: Norton #271N; Rheem #62-22868-92;  
Robertshaw #41-408; Trane #B340039P01;  
White Rodgers #767A-372*

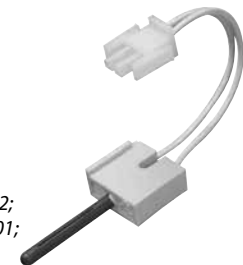

## Order No. ER1409

Ceramic block: C  
Terminal block: D

*Fits: Carrier #LH33ZS001, #LH33ZS002,  
#LH33ZS003, #LH33ZS004;  
Norton #271N; Robertshaw #41-409*



## Order No. ER1409N

Ceramic block: C  
Terminal block: D

*Fits: Carrier #LH33ZS001, #LH33ZS002,  
#LH33ZS003, #LH33ZS004; Norton #271N;  
Robertshaw #41-409*



## Order No. ER1410

Ceramic block: G  
Terminal block: B

*Fits: Norton #271N;  
Robertshaw #41-410;  
Trane #B144676P01*

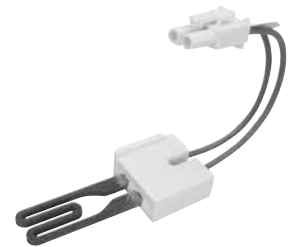



# FURNACE IGNITERS

Silicon Carbide Furnace Igniters are made in USA and  approved

## Order No. ER1410N

Ceramic block: G  
Terminal block: B



Fits: Norton #271N;  
Robertshaw #41-410; Trane #B144676P01

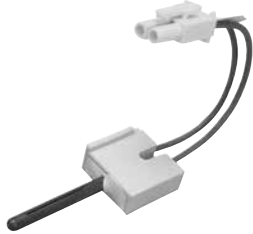

## Order No. ER1411

Ceramic block: B  
Terminal block: C

Fits: Norton #271N;  
Rheem #62-22868-82;  
Robertshaw #41-411

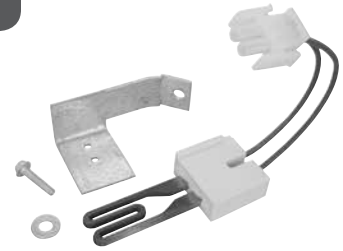

## Order No. ER1411N

Ceramic block: B  
Terminal block: C



Fits: Norton #271N;  
Rheem #62-22868-82; Robertshaw #41-411

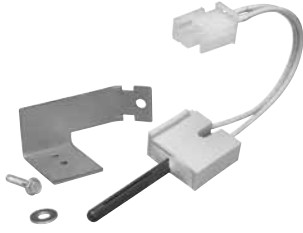

## Order No. ER1412

Ceramic block: F  
Terminal block: D

Fits: Norton #271NM;  
Robertshaw #41-412



## Order No. ER1412N

Ceramic block: F  
Terminal block: D



Fits: Norton #271NM;  
Robertshaw #41-412



## Order No. ER1474052P

Ceramic block: B  
Terminal block: 1/4" female terminals

Fits: Coleman #1474-052P



## Order No. ER622266992

Ceramic block: 1/4" width  
Terminal block: C

Fits: Rheem #62-22669-92



## Order No. ER767A361

Ceramic block: H  
Terminal block: D

Fits: White Rodgers #767A-361



## Order No. ER903758

Ceramic block: H  
Terminal block: stripped ends



Fits: Whirlpool #903758



## Order No. ERIG101

Fits: Nordyne #902661

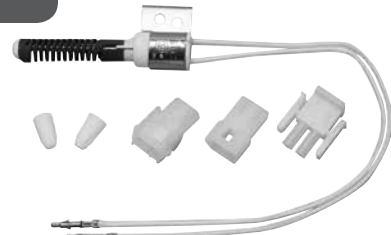

# FURNACE PARTS

## Order No. ER1000

### Universal Hot Surface Ignition Module

- Flame status & diagnostic LED indicator for accurate troubleshooting
- Multi-position DIP switch allowing a broad range of field programmable timing selections
- Timing selections are transferred to permanent memory after ten normal heating cycles are completed

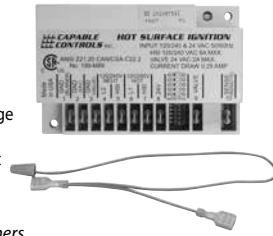

Replaces Honeywell #S8610U1000 & many others

## Order No. ER1003

### Universal Intermittent Spark Ignition Module

24VAC 50/60 Hz  
Prepurge: 1 sec.  
90 sec. trial, 5 min. retry



Replaces Honeywell #S8610U1003  
Also replaces popular modules made by Camstat, Fenwal, HSC, Penn Johnson & Robertshaw

## Order No. ER60J00

Ignition Module  
24VAC  
50/60 Hz

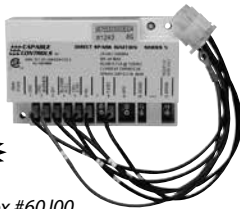

**NEW!**

Replaces Lennox #60J00

## Order No. ER318984-753

Inducer Motor

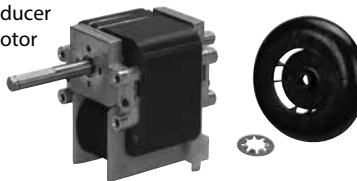

Replaces Carrier #318984-753

## Order No. ERHY10LF286

Thermal Fuse



Fits: Carrier #HY10LF286

## Order No. HG050

Hygrometer



**NEW!**

## Order No. VC-1

Vent Cover



## Order No. WEB-1

Universal Adjustable Furnace Filter

- Two-phase electrostatic filter system traps dust, mold spores, animal dander and pollen
- Traps over 90% of particles ranging from 0.245 to 80 microns
- Laboratory tested and guaranteed
- Fully adjustable to fit standard sizes from 14" x 20" to 20" x 25", 1" thick



**5 Year Warranty**

**Electrostatic High Efficiency Washable Filter**

Order No. EP2002 24" x 12" - 18"

Order No. EP2003 25" x 12" - 20"

Order No. EP2004 16" x 20" - 32"

Order No. EP2005 20" x 20" - 32"

Order No. EP2006 24" x 20" - 32"

Order No. EP2007 25" x 20" - 32"



### Expand-A-Pleat Expandable Furnace Filter

- No assembly required, low pressure drop
- Electrostatically charged, removes pet dander
- Material - MERV 8, made in the USA
- Captures airborne allergens & particulates



Adjustable frame easily slides to fit central air system without using scissors or other tools



Each filter is clearly printed to make it easy to find desired size



Expanded metal supports each pleat and ensures the filter maintains its shape even in high velocity central air systems



Locking tab slides into place to securely hold the filter at selected size.

## Order No. ER02527773700

Flame Sensor



## Order No. ERLH680014

Flame Sensor



## Order No. ERLH680013

Flame Sensor



HVAC

# HUMIDIFIER FILTERS, WICKS & PADS BY BRAND

## HUMIDIFIER FILTER STYLES

**A**

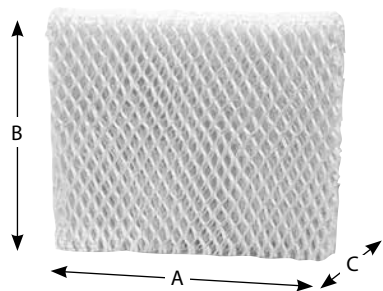

**Wick Filter**

A = Length  
B = Height  
C = Depth

**B**

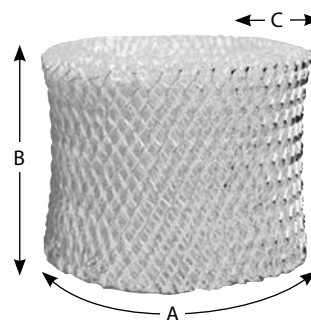

**Wick Filter**

A = Circumference  
B = Height  
C = Depth

**C**

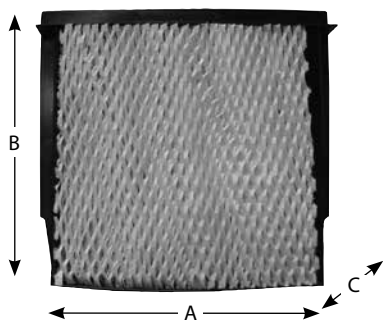

**Wick Filter**

A = Length  
B = Height  
C = Depth

**D**

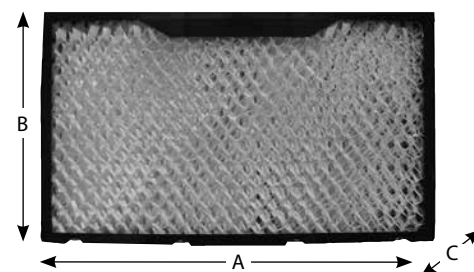

**Wick Filter**

A = Length  
B = Height  
C = Depth

**E**

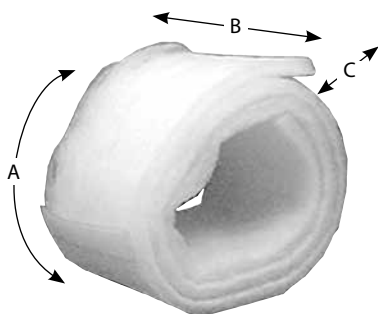

**Drum-Type Filter**

A = Circumference  
B = Height  
C = Depth

**F**

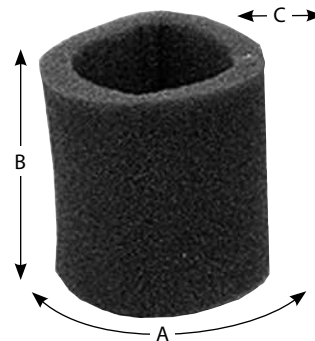

**Drum-Type Filter**

A = Circumference  
B = Height  
C = Depth

**G**

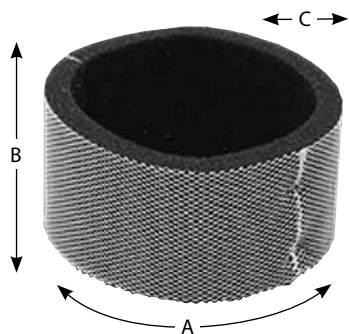

**Drum-Type Filter**

A = Circumference  
B = Height  
C = Depth

**H**

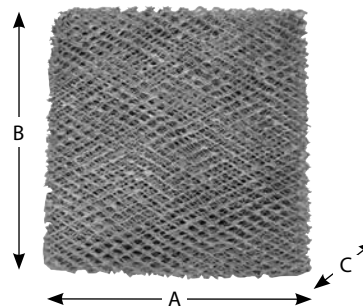

**Metal Water Pad**

A = Length  
B = Height  
C = Depth

# HUMIDIFIER FILTERS, WICKS & PADS BY BRAND

OEM	Model #	ERP #	Style	A	B	C	Qty/Pk	Type
Air King	H800, H805, H810, H820, H835	6HB	E	65"	6"	3/8"	1	Drum-Type Universal cut to fit
	300, 400, 410	HM2	G	24"	8"		1	Drum-Type Filter (fits 8")
Aprilaire	110, 220, 550, 550A, 558 (10)	A10	H	10"	9-7/8"	1-7/8"	1	Water Pad
	112, 136, 224, 440, 445, 445A, 448 (12)	A12	H	14-3/4"	11-3/8"	1-5/8"	1	Water Pad
	350, 360, 560, 560A, 568, 600, 700, 760, 760A, 768 (35)	A35	H	13"	10"	1-5/8"	1	Water Pad
Arctic Stream	DA1007	D09-C	A	8"	7-1/4"	2"	1	Wick Filter
	DA-1005	DU3-C	A	7-3/4"	7-1/4"	1"	3	Wick Filter
Autoflo	40, 40S, 250 (40EP)	4EP	H	9-1/4"	9"	1-7/8"	1	Water Pad
	200, 800BP, 2500 (200EP)	A20	G	25-1/8"	4-1/2"		1	Drum-Type Filter (fits 4-1/2")
	97 (97EP)	A97	G	15-3/8"	5-1/8"		1	Drum-Type Filter (fits 9")
	SC-15	SCEP	H	11-1/2"	11-1/2"	1-1/2"	1	Water Pad
Beaver	900	HM2	G	24"	8"		1	Drum-Type Filter (fits 8")
Bemis/Waterwick		6HB	E	65"	6"	3/8"	1	Drum-Type Universal cut to fit
	3000, 5000, 7000, DP3, B28 Series (1040)	B40-C	C	8-3/4"	8-1/2"	3"	2	Wick Filter
	4000, 6000 ED11 Series consoles (1041)	CB41	D	17"	9-7/8"	4-7/8"	1	Wick Filter
	Spacesaver 8000 console (1043)	CB43	A	12-1/4"	10-1/2"	4-1/2"	1	Wick Filter
	H12 console, H10400 (1045)	CB45	D	16-9/16"	11-3/4"	4-7/8"	1	Wick Filter
Berns Air King	H800, H805, H810, H820, H835	6HB	E	65"	6"	3/8"	1	Drum-Type Universal cut to fit
Bionaire	W-0210s, W-0210, W-3040, W-0305, W-0310, W-2, W-2s, W-6, 6s, W-7, W-9, 9s, 9H, C22, C33 (911D)	CBW9	A	9-1/4"	7-1/4"	2-1/2"	2	Wick Filter
	BCM-4600, BCM-5520, BCM-5520RC, BCM-6000, BCM-6010RC, BCM-7203, BCM-7203RC, BCM-7305RC, BCM-7305RCB, MCM-5520, (BWF-100) (HWF-100)	H100-3	A	8"	5"	1"	6	Wick Filter
	BCM-1745	H64-C	B	20"	6-1/8"	1"	1	Wick Filter
	BCM1845, BCM1850, BCM1855	H65-C	B	21-1/2"	7-1/2"	1"	1	Wick Filter
	W12, W14, W15, (BWF1500-UC)	H75-C	B	28"	7-1/2"	1"	1	Wick Filter
Bryant/Carrier	HUMBBLB217, HUMBBLFP1218	A35	H	13"	10"	1-5/8"	1	Water Pad
	914A	HM2	G	24"	8"		1	Drum-Type Filter (fits 8")
	HUMCCLBP2217, HUMBBLFP1218	A35	H	13"	10"	1-5/8"	1	Water Pad
	49WS	HM2	G	24"	8"		1	Drum-Type Filter (fits 8")
Chippewa	220	A10	H	10"	9-7/8"	1-7/8"	1	Water Pad
	224, 225, 226	A12	H	14-3/4"	11-3/8"	1-5/8"	1	Water Pad
Comfort-Aire	HCF10, HCF12, HCF120, HCF15	6HB	E	65"	6"	3/8"	1	Drum-Type Universal cut to fit
Coolerator		6HB	E	65"	6"	3/8"	1	Drum-Type Universal cut to fit
Coronado	1435, 1439, 1446, 1448, 1449, 1452, 1457, 1459, 1462, 4263, 4264, 4265, 4268, 4269	6HB	E	65"	6"	3/8"	1	Drum-Type Universal cut to fit
Crosley	C4026	6HB	E	65"	6"	3/8"	1	Drum-Type Universal cut to fit
Duracraft	DA1005, DA1007, DA7800, DH799, DH800, DH804, DH805, DH806, DH807, DH812, DH815, DH821, DH822, DH823, DH824, DH836, DH837, DH837B, DH840, DH950	ALL1	A	8-1/8"	7"	1"	2	Universal Wick Filter cut to fit
	DH803, 804, 805, 806, 807, 817, DA1007 (AC-809) (HC-809)	D09-C	A	8"	7-1/4"	2"	1	Wick Filter
Duracraft	DH830, 832 (AC-813)	D13-C	A	6"	3-3/4"	1-1/2"	2	Wick Filter
	DH836, 837, 837B, 950 (AC-814)	D14-C	A	5-7/8"	5-1/2"	1-3/4"	1	Wick Filter
	DH831 (AC-818) (HC-818)	D18-C	A	9"	8-1/4"	2"	1	Wick Filter
	DCM-200, HCM-890, DH888, 890, 890C (AC-888) (HC-888)	D88	B	19"	6-1/2"	1"	1	Wick Filter
	DH799, 800, 812, 840, 7800, DA1005 (AC-801)	DU3-C	A	7-3/4"	7-1/4"	1"	3	Wick Filter
	H64-C	B	20"	6-1/8"	1"	1	Wick Filter	

For a complete cross reference list, search with your model or part number on our website at [www.erparts.com](http://www.erparts.com)

# HUMIDIFIER FILTERS, WICKS & PADS BY BRAND

OEM	Model #	ERP #	Style	A	B	C	Qty/Pk	Type
Edison	19A, 19B, 20A, 29A, 29B, 39B, 49A, 49B, 59B, 79A, 434101, 534081, 534101, 534121, 534142, 534151, 534171, 9A11G-A, 9A12G-A, 9A14G-A, 9A12M-A, 9A15G-A, 9B-05MA, 9B08G-A, 9B08M-A, 9B10C-A, 9B11C-A, HJ08-A, HJ08B	6HB	E	65"	6"	3/8"	1	Drum-Type Universal cut to fit
		ED4	E	57-1/2"	4-7/8"	3/8"	1	Drum-Type Filter (fits 4-3/4")
Emerson	HD500, HD1211, HD2412, HD6000, HD6200, HD7002, HD8000, HD8001, HD07W, HD08W, HD080WV, HD10W, HD12W, HD12WV, HD73W, HD14W, HD15W	ALL3	A	10-3/4"	6-1/2"	2"	4	Universal Wick Filter cut to fit
	HD500, HD6200, HD1205, HD1211, HD2412, HD-7005, HD7002 (HDC-2R)	E2R	A	11"	6-1/4"	2"	2	Wick Filter
	MA0950, MA1200	EF1	B	30-1/4"	7-3/4"	3/4"	1	Wick Filter
	MA0800/0	EF2	B	24"	8"	1"	1	Wick Filter
	750, 755, 850, HD-03W, 04W (HDC-3T)	EPT	A	6-1/4"	5-3/8"	4-3/8"	1	Wick Filter
	HD230, 1100, 1102, 1200, 1202, 1204, 1212, 1300, 1303, 1305, 1405, 1406, 1407, (HDC-12) (HDC-23), HD12001, HD12003, HD1202C, HD1202C1C, HD12041, HD13000, HD13001, HD13002, HD1300W, HD1300, HD13050, HD14050, HD14060	ES12	A	9"	6-1/2"	2-3/8"	4	Wick Filter
	HD07W, HD08WV, HD08W, HD10W, HD12WV, HD12W, HD13W, HD14W, HD15W, HD6000, HD8000, HD8001 (HDC-1)	ESW-C	A	11"	6-3/8"	4-1/2"	2	Wick Filter
HD200, 300, 400 (HDF-1), HD1021	K01	B	24"	5-1/4"	1/2"	1	Wick Filter	
Envionizer	63-1508	HW500	B	19"	5"	1"	1	Wick Filter
GE		ALL2	B	33"	7-3/4"	1"	1	Universal Wick Filter cut to fit
	106663, 106763	H65-C	B	21-1/2"	7-1/2"	1"	2	Wick Filter
General	709, 990, 1040, 1042, 1137 (990-13)	G13	H	12"	9-1/4"	1-3/8"	1	Water Pad
	950 Elite, 1099 (1099-20)	G20	H	12"	9-1/4"	1-3/8"	1	Water Pad
	65, 67, 81	HM2	G	24"	8"		1	Drum-Type Filter (fits 8")
Gerry	650	H55-C	A	9"	7-1/2"	1-1/2"	2	Universal Wick Filter cut to fit
Halls	HLS1300, 1400	H62/85	B	17-1/2"	4-1/4"	1"	1	Wick Filter
Hamilton	12HF (EP037)	A10	H	10"	9-7/8"	1-7/8"	1	Water Pad
	8FT (EP035)	HA8	H	11"	10"	1-1/2"	1	Water Pad
Hamilton	4D, 98, 200D, 310, 400, 400D, 800D, 4000	HM2	G	24"	8"		1	Drum-Type Filter (fits 8")
Hamilton Beach	05518, 05519	H62/85	B	17-1/2"	4-1/4"	1"	1	Wick Filter
	05520, 05521	H64-C	B	20"	6-1/8"	1"	1	Wick Filter
Hermidifier (Trion)		HM2	G	24"	8"		1	Drum-Type Filter (fits 8")
Holmes/Family Care	HM650, HM725, HM730, HM1550, HM1555, HCW3040, HCW3060	ALL1	A	8-1/8"	7"	1"	2	Universal Wick Filter cut to fit
	HM850, HM1845, HM1850, HM1885, HM1975, HM2059, HM2060, HM2090, HM3000, HM3400, HM3500, HM3600, HM3640, HM3650, HM3800, HM3850, HM4000	ALL2	B	33"	7-3/4"	1"	1	Universal Wick Filter cut to fit
Holmes/Family Care	HM-630, -4600, -6000, -6000RC, -6005, -7203, -7203RC, -7204, -729, -7305, -7305RC, -7306, -7306RC, -7405, -7405RC (HWF-100)	H100-3	A	8"	5"	1"	6	Wick Filter
	HM-1550, 1555 (HWF-45)	H45-C	A	8-1/4"	6-1/2"	1"	2	Wick Filter
	HM-250, HM-405, HM-406, HM-2000, HM1000, HM1025, HM1050 (HWF-55)	H55-C	A	9"	7-1/2"	1"	1	Wick Filter
	HM-1230, 1245, 1275, 1280, 1285, 1290, 1295, 1450, 1700, 1740, 1760, 1910, 2005, 2025, 2030, 2408 (HWF-62)	H62/85	B	17-1/2"	4-1/4"	1"	1	Wick Filter
	HM-1645, 1730, 1745, 1746, 1750, 2200, 2220 (HWF-64)	H64-C	B	20"	6-1/8"	1"	1	Wick Filter
	HM-1800, 1840, 1845, 1850, 1851, 1855, 1865, 1888, 1889, 1975, 2059, 2060W, 2090, 3000, NOTE: 3800 & 3850 need 3 filters NOTE: 4000 needs 4 filters	H65-C	B	21-1/2"	7-1/2"	1"	1	Wick Filter

For a complete cross reference list, search with your model or part number on our website at [www.erparts.com](http://www.erparts.com)



# HUMIDIFIER FILTERS, WICKS & PADS BY BRAND

OEM	Model #	ERP #	Style	A	B	C	Qty/Pk	Type
Holmes/Family Care	HM-850, 3400, 3500, 3600, 3640, 3641, 3650, 3655 (HWF-75) (HF221)	H75-C	B	28"	7-1/2"	1"	1	Wick Filter
HomeLine	400	HM2	G	24"	8"		1	Drum-Type Filter (fits 8")
Honeywell	HE220A/B, HE225A/B (HC22A)	A10	H	10"	9-7/8"	1-7/8"	1	Water Pad
	HC26A1008, HC26E1004, HE260, HE260A/B, HE265, HE265A/B, HE360, HE360A/B, HE365, HE365A/B, ME360 (HC26A)	A35	H	13"	10"	1-5/8"	1	Water Pad
Honeywell/Enviraire	HCM-25 (HAC-506)	D13-C	A	6"	3-3/4"	1-1/2"	2	Wick Filter
	HCW-3040 (HAC-514)	D14-C	A	5-7/8"	5-1/2"	1-3/4"	1	Wick Filter
	HCM-890 (AC-888) (HC-888)	D88	B	19"	6-1/2"	1"	1	Wick Filter
	HCM-3060 (HAC-801)	DU3-C	A	7-3/4"	7-1/4"	1"	3	Wick Filter
	HCM-535, 535-20, 540, 550, 550-19, 551, 560, 630, 635, 645, 650, 1000 Series, 2000 Series, ECM-250i, HCM-310T, HCM-530 (HAC-504) (HAC-504AW)	HW500	B	19"	5"	1"	1	Wick Filter
Humid-Aire	Neptune	A12	H	14-3/4"	11-3/8"	1-5/8"	1	Water Pad
Hunter	32300 (31913), 32500, 34500 (31915)	D18-C	A	9"	8-1/4"	2"	1	Wick Filter
Intl. Comfort Products	HM1CLB17A, HM1CLF18A	A35	H	13"	10"	1-5/8"	1	Water Pad
JC Penney	Portable 4-1/2" Drum Type	6HB	E	65"	6"	3/8"	1	Drum-Type Universal cut to fit
Kaz	Kaz 3020, Vicks V3100, 3500, 3600, ReliOn RH1300 (WF2) (HC-835)	HW500	B	19"	5"	1"	1	Wick Filter
	Kaz 3000, 3300, 3400 (WF1)	K01	B	24"	5-1/4"	1/2"	1	Wick Filter
Kenmore		ALL1	A	8-1/8"	7"	1"	2	Universal Wick Filter cut to fit
		ALL2	B	33"	7-3/4"	1"	1	Universal Wick Filter cut to fit
		ALL3	A	10-3/4"	6-1/2"	2"	4	Universal Wick Filter cut to fit
	14102	D09-C	A	8"	7-1/4"	2"	1	Wick Filter
	14803, 14804	D18-C	A	9"	8-1/4"	2"	1	Wick Filter
	14108 (1478)	DU3-C	A	7-3/4"	7-1/4"	1"	3	Wick Filter
	14407, 14451, 1442, 29974 (14909), 14416, 14413 (needs 4 filters) (14912)	E2R	A	11"	6-1/4"	2"	2	Wick Filter
	144105	EF1	B	30-1/4"	7-3/4"	3/4"	1	Wick Filter
		EF2	B	24"	8"	1"	1	Wick Filter
	14415, 14417, 14452, 14453, 14454	ES12	A	9"	6-1/2"	2-3/8"	4	Wick Filter
14106, 14408, 14412, 14414, 14424, 14808, 29966, 29967, 29968, 29969, 29970, 29971, 29976 (HDC-1)	ESW-C	A	11"	6-3/8"	4-1/2"	2	Wick Filter	
Lasko	550L, 5000L	A10	H	10"	9-7/8"	1-7/8"	1	Water Pad
	400L, 900	HM2	G	24"	8"		1	Drum-Type Filter (fits 8")
	1000, 1150, 1155 (CHF50)	L15	A	14-3/4"	12-1/4"	1-3/4"	1	Wick Filter
	1128, 1129 (THF8) (2010870)	L8-C	A	14-3/4"	12-1/4"	1-3/4"	1	Wick Filter
LAU	9335	LS35	F	24-1/2"	8-1/4"	3/4"	1	Drum-Type Filter
	9336	LS36	F	23-7/8"	6"	1"	1	Drum-Type Filter
Leigh	1100	4EP	H	9-1/4"	9"	1-7/8"	1	Water Pad
Little Giant	LGH, PB-S1, P1	4EP	H	9-1/4"	9"	1-7/8"	1	Water Pad
Lobb	WA-2700, WA-1, WA-2, AD-1	HM2	G	24"	8"		1	Drum-Type Filter (fits 8")
McGraw Edison		6HB	E	65"	6"	3/8"	1	Drum-Type Universal cut to fit
Montgomery Ward	LN 6024, LN 6030, LN 6032, LN 6034, LN 6040, LN 6041, LN 6043, LN 6044, LN 6050, LN 6051, LN 6053, LN 6054, LN 6062, LN6151	6HB	E	65"	6"	3/8"	1	Drum-Type Universal cut to fit
	LN 6024, LN 6034	ED4	E	57-1/2"	4-7/8"	3/8"	1	Drum-Type Filter (fits 4-3/4")
Peerless Aire	31002 (200EP)	A20	G	25-1/8"	4-1/2"		1	Drum-Type Filter (fits 4-1/2")
ReliOn	RCM832 (WF813)	D13-C	A	6"	3-3/4"	1-1/2"	2	Wick Filter
	RH1300 (WF2) (HC-835)	HW500	B	19"	5"	1"	1	Wick Filter

For a complete cross reference list, search with your model or part number on our website at [www.erparts.com](http://www.erparts.com)



# HUMIDIFIER FILTERS, WICKS & PADS BY BRAND

OEM	Model #	ERP #	Style	A	B	C	Qty/Pk	Type
Robitussin	DH832, RCM832	D13-C	A	6"	3-3/4"	1-1/2"	2	Wick Filter
	DH835	HW500	B	19"	5"	1"	1	Wick Filter
Skuttle	90, 90S, 109, 190, H1005	HM2	G	24"	8"		1	Drum-Type Filter (fits 8")
Sunbeam	1114, 1115 (6611)	S11	A	9-5/8"	7-1/2"	1-1/2"	1	Wick Filter
Super	700 (EP034)	HM2	G	24"	8"		1	Drum-Type Filter (fits 8")
Thomas A. Edison	E19, 29, 39, 49, 59, 79, NL60	6HB	E	65"	6"	3/8"	1	Drum-Type Universal cut to fit
Toastmaster		6HB	E	65"	6"	3/8"	1	Drum-Type Universal cut to fit
	3410, 3414, 3420, 3430, 3440	ED4	E	57-1/2"	4-7/8"	3/8"	1	Drum-Type Filter (fits 4-3/4")
Totaline		A35	H	13"	10"	1-5/8"	1	Water Pad
Vaporall		6HB	E	65"	6"	3/8"	1	Drum-Type Universal cut to fit
Vicks	V3100, 4053, 24021 (4001)	HW500	B	19"	5"	1"	1	Wick Filter
Vornado	221, 232, 421, 432, 3120-900 (MD1-0002)	H55-C	A	9"	7-1/2"	1-1/2"	2	Universal Wick Filter cut to fit
W.C. Wood	WH10-GA, WH12-GB, WH12-GE	6HB	E	65"	6"	3/8"	1	Drum-Type Universal cut to fit
Wait	90S, 900, PRO-100	HM2	G	24"	8"		1	Drum-Type Filter (fits 8")
Walton	600, 620, 660 (PLMD)	A12	H	14-3/4"	11-3/8"	1-5/8"	1	Water Pad
Ward	24, 700, 58518, 58536	HM2	G	24"	8"		1	Drum-Type Filter (fits 8")
West Bend	4009, 4017 (4016) (4036)	6HB	E	65"	6"	3/8"	1	Drum-Type Universal cut to fit
White-Westinghouse		6HB	E	65"	6"	3/8"	1	Drum-Type Universal cut to fit
		ALL1	A	8-1/8"	7"	1"	2	Universal Wick Filter cut to fit
	WWHM1840	ALL2	B	33"	7-3/4"	1"	1	Universal Wick Filter cut to fit
	WWH-8002	D19-C	A	8-3/4"	8-5/8"	1-3/4"	3	Wick Filter
	WWHM1285, WWHM1600 (WWH-620)	H62/85	B	17-1/2"	4-1/4"	1"	1	Wick Filter
	WWHM1645	H64-C	B	20"	6-1/8"	1"	1	Wick Filter
	WWHM1840	H65-C	B	21-1/2"	7-1/2"	1"	1	Wick Filter
	WWHM3600, WWHM3300	H75-C	B	28"	7-1/2"	1"	1	Wick Filter

## Order No. ALL1 2 per pack

- Universal Cut to Fit Humidifier Filter  
*No Marking! No Measuring!*
- 8-1/8" x 7" x 1" cut to fit
  - Fits MOST common rectangle filter humidifiers
  - Complete with instructions & cutting template
  - Anti-microbial treated



### Fits Models

Duracraft: DH799, DH800, DH803, DH804, DH805, DH806, DH807, DH812, DH815, DH821, DH822, DH823, DH824, DH836, DH837, DH837B, DH840, DH950, DA1005, DA1007, DA7800

Holmes: HM650, HM725, HM726, HM730, HM1550, HM1555, HCW3040, HCM3060

Kenmore: 14102, 14108

White Westinghouse: WWHM7250

## Order No. ALL2 1 per pack

- Universal Cut to Fit Humidifier Filter
- 33" x 7-3/4" x 1" cut to fit
  - Velcro strips included to form drum shape
  - Cutting instructions on box
  - Anti-microbial treated

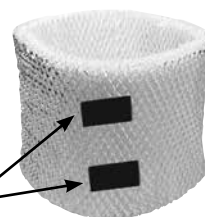

Velcro strips

### Fits Models

GE: 10663

Holmes: HM850, HM1845, HM1850, HM1855, HM1975, HM2059, HM2060W, HM2090, HM3000, HM3400, HM3500, HM3600, HM3640, HM3650, HM3800, HM3850, HM4000

Kenmore: 14102, 14108

White Westinghouse: WWHM1840, WWHM3300, WWHM3600

## Order No. ALL3 4 per pack

- Universal Cut to Fit Humidifier Filter
- 10-3/4" x 6-1/2" x 2" cut to fit
  - Separation instructions included
  - Anti-microbial treated

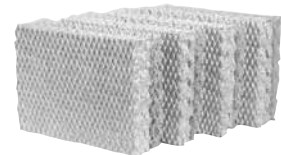

### Fits Models

Emerson: HD-500, HD-1211, HD-2412, HD-6000, HD-6200, HD-7002, HD-8000, HD-8001, HD-07W, HD-08W, HD-08WW, HD-10W, HD-12W, HD-12WW, HD-13W, HD-14W, HD-15W

Kenmore: 14407, 14413, 14451, 14452, 14453, 1442, 29966, 29967, 29968, 29969, 29970, 29971, 29974, 29976

For a complete cross reference list, search with your model or part number on our website at [www.erparts.com](http://www.erparts.com)

# MISCELLANEOUS HUMIDIFIER/HVAC SUPPLIES

## Order No. 1C 32 oz.

- Humidiclean™ Extra Strength Humidifier Cleaner
- Rapidly dissolves calcium scale, lime & rust
  - Recommended for wicking, furnace, ultrasonics & vaporizers
  - Helps control odor & prolongs vaporizer/humidifier life
  - Made in USA



## Order No. 1T 32 oz.

- Humidiclean™ Extra Strength Humidifier Water Treatment
- Helps prevent lime & iron from accumulating on filters & moving parts
  - Neutralizes water
  - Controls odor & prolongs humidifier life
  - Made in USA
- NOTE: Not for use in vaporizers/ultrasonics*



## Order No. 3BT 32 oz.

- Original BT™ Humidifier Bacteriostatic Water Treatment
- Helps control bacterial algae build-up & eliminates odors in all evaporative console and all wicking type humidifiers
  - Made in USA
- NOTE: Not for use in vaporizers/ultrasonics*



## Order No. 25019

Solenoid

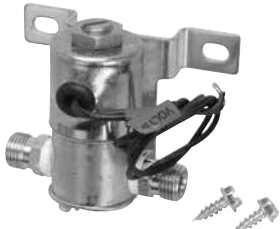

## Order No. 21872A16

Humidifier Belt

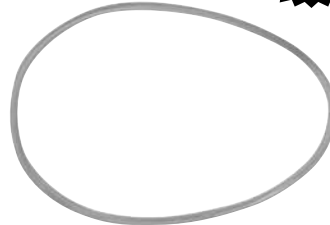

*Used on some models of Edison and Toastmaster*

## Order No. A-4101

- Power-Pac Refrigeration Condenser Cleaner
- Non-foaming spray
  - 20 oz.



## Order No. B-24

- Bubble Up - 8 oz.
- Indicates leaks
  - Clings to surfaces
  - Dauber type applicator



## Order No. H-2800

- Foam Insulation Tape
- 1/8" x 1/2" x 30 ft.
  - Insulates hot & cold pipes
  - Stops condensation & drips
  - Adheres to non-porous surfaces & itself



## Order No. H-2901

- Sealing Gum Cords
- Easily formed by hand
  - Will not dry or crack
  - Adheres to non-porous surfaces



## Order No. H-EC01

- Enviro-Coil Concentrate Cleaner
- 1 gal.
  - Attacks dirt build up not metal
  - Safe for the environment, personnel & equipment
  - For air cooled condensers: mix w/ 4 parts water
  - For evaporators: mix with 8 parts water
  - No rinsing required
  - USDA accepted



## Order No. SB-32

- Leak Seak
- 1 qt.
  - Spray reaches hard to get at places
  - Clings to vertical and underside pipes
  - Non-corrosive, non-clogging



## Order No. ZC-02

- Zip Clean Evaporator Coil Cleaner
- 18 oz.
  - Cleans evap. coils quickly & easily
  - Prevents future dirt build up
  - No rinsing required



HVAC

# HVAC BELTS

## BELT PROFILES

**FHP V-Belt**

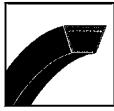

**Multi-Plus V-Belt**

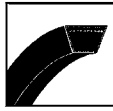

**Deep Wedge Belt**



**Multi-Cogged Belt**

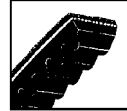

**Raw Edge Cogged Belt**



## BELT SPECIFICATIONS

*\*Other belts available, please call for pricing*

ERP #	Reference	Belt Type
ER3L150	3L150	FHP V-Belt
ER3L160	3L160	FHP V-Belt
ER3L170	3L170	FHP V-Belt
ER3L180	3L180	FHP V-Belt
ER3L190	3L190	FHP V-Belt
ER3L200	3L200	FHP V-Belt
ER3L210	3L210	FHP V-Belt
ER3L220	3L220	FHP V-Belt
ER3L230	3L230	FHP V-Belt
ER3L240	3L240	FHP V-Belt
ER3L250	3L250	FHP V-Belt
ER3L260	3L260	FHP V-Belt
ER3L270	3L270	FHP V-Belt
ER3L280	3L280	FHP V-Belt
ER3L290	3L290	FHP V-Belt
ER3L300	3L300	FHP V-Belt
ER3L310	3L310	FHP V-Belt
ER3L320	3L320	FHP V-Belt
ER3L330	3L330	FHP V-Belt
ER3L340	3L340	FHP V-Belt
ER3L350	3L350	FHP V-Belt
ER3L360	3L360	FHP V-Belt
ER3L370	3L370	FHP V-Belt
ER3L380	3L380	FHP V-Belt
ER3L390	3L390	FHP V-Belt
ER3L400	3L400	FHP V-Belt
ER3L410	3L410	FHP V-Belt
ER3L420	3L420	FHP V-Belt
ER3L430	3L430	FHP V-Belt
ER3L440	3L440	FHP V-Belt
ER3L450	3L450	FHP V-Belt
ER3L460	3L460	FHP V-Belt
ER3L470	3L470	FHP V-Belt
ER3L480	3L480	FHP V-Belt
ER3L490	3L490	FHP V-Belt
ER3L500	3L500	FHP V-Belt
ER3L510	3L510	FHP V-Belt
ER3L530	3L530	Multi-Plus Belt

ERP #	Reference	Belt Type
ER3L560	3L560	FHP V-Belt
ER3L580	3L580	FHP V-Belt
ER3L610	3L610	FHP V-Belt
ER3V355		Deep Wedge Belt
ER3V710		Deep Wedge Belt
ER3V830		Deep Wedge Belt
ER3V850		Deep Wedge Belt
ER4L170	4L170	Multi-Plus Belt
ER4L180	4L180	Multi-Plus Belt
ERA100	A100	Multi-Plus Belt
ERA110	A110	Multi-Plus Belt
ERA136	A136	Multi-Plus Belt
ERA18	4L200	Multi-Plus Belt
ERA19	4L210	Multi-Plus Belt
ERA20	4L220	Multi-Plus Belt
ERA21	4L230	Multi-Plus Belt
ERA22	4L240	Multi-Plus Belt
ERA23	4L250	Multi-Plus Belt
ERA24	4L260	Multi-Plus Belt
ERA25	4L270	Multi-Plus Belt
ERA26	4L280	Multi-Plus Belt
ERA27	4L290	Multi-Plus Belt
ERA28	4L300	Multi-Plus Belt
ERA29	4L310	Multi-Plus Belt
ERA30	4L320	Multi-Plus Belt
ERA31	4L330	Multi-Plus Belt
ERA32	4L340	Multi-Plus Belt
ERA33	4L350	Multi-Plus Belt
ERA34	4L360	Multi-Plus Belt
ERA35	4L370	Multi-Plus Belt
ERA36	4L380	Multi-Plus Belt
ERA37	4L390	Multi-Plus Belt
ERA38	4L400	Multi-Plus Belt
ERA39	4L410	Multi-Plus Belt
ERA40	4L420	Multi-Plus Belt
ERA41	4L430	Multi-Plus Belt
ERA42	4L440	Multi-Plus Belt
ERA43	4L450	Multi-Plus Belt

ERP #	Reference	Belt Type
ERA44	4L460	Multi-Plus Belt
ERA45	4L470	Multi-Plus Belt
ERA46	4L480	Multi-Plus Belt
ERA47	4L490	Multi-Plus Belt
ERA48	4L500	Multi-Plus Belt
ERA49	4L510	Multi-Plus Belt
ERA50	4L520	Multi-Plus Belt
ERA51	4L530	Multi-Plus Belt
ERA52	4L540	Multi-Plus Belt
ERA53	4L550	Multi-Plus Belt
ERA54	4L560	Multi-Plus Belt
ERA55	4L570	Multi-Plus Belt
ERA56	4L580	Multi-Plus Belt
ERA57	4L590	Multi-Plus Belt
ERA58	4L600	Multi-Plus Belt
ERA59	4L610	Multi-Plus Belt
ERA60	4L620	Multi-Plus Belt
ERA61	4L630	Multi-Plus Belt
ERA62	4L640	Multi-Plus Belt
ERA63	4L650	Multi-Plus Belt
ERA64	4L660	Multi-Plus Belt
ERA65	4L670	Multi-Plus Belt
ERA66	4L680	Multi-Plus Belt
ERA67	4L690	Multi-Plus Belt
ERA68	4L700	Multi-Plus Belt
ERA69	4L710	Multi-Plus Belt
ERA70	4L720	Multi-Plus Belt
ERA71	4L730	Multi-Plus Belt
ERA72	4L740	Multi-Plus Belt
ERA73	4L750	Multi-Plus Belt
ERA74	4L760	Multi-Plus Belt
ERA75	4L770	Multi-Plus Belt
ERA76	4L780	Multi-Plus Belt
ERA77	4L790	Multi-Plus Belt
ERA78	4L800	Multi-Plus Belt
ERA79	4L810	Multi-Plus Belt
ERA80	4L820	Multi-Plus Belt
ERA81	4L830	Multi-Plus Belt

# HVAC BELTS

## BELT SPECIFICATIONS

ERP #	Reference	Belt Type
ERA82	4L840	Multi-Plus Belt
ERA83	4L850	Multi-Plus Belt
ERA84	4L860	Multi-Plus Belt
ERA85	4L870	Multi-Plus Belt
ERA86	4L880	Multi-Plus Belt
ERA87	4L890	Multi-Plus Belt
ERA88	4L900	Multi-Plus Belt
ERA89	4L910	Multi-Plus Belt
ERA90	4L920	Multi-Plus Belt
ERA91	4L930	Multi-Plus Belt
ERA92	4L940	Multi-Plus Belt
ERA93	4L950	Multi-Plus Belt
ERA94	4L960	Multi-Plus Belt
ERA95	4L970	Multi-Plus Belt
ERA96	4L980	Multi-Plus Belt
ERA97	4L990	FHP V-Belt
ERAX26	AX26	Multi-Cogged Belt
ERAX31	AX31	Multi-Cogged Belt
ERAX33	AX33	Multi-Cogged Belt
ERAX34	AX34	Multi-Cogged Belt
ERAX35	AX35	Multi-Cogged Belt
ERAX36	AX36	Multi-Cogged Belt
ERAX37	AX37	Multi-Cogged Belt
ERAX38	AX38	Multi-Cogged Belt
ERAX42	AX42	Multi-Cogged Belt
ERAX51	AX51	Multi-Cogged Belt
ERAX54	AX54	Multi-Cogged Belt
ERAX60	AX60	Multi-Cogged Belt
ERB100	B100	Multi-Plus Belt
ERB103	B103	Multi-Plus Belt
ERB105	B105	Multi-Plus Belt
ERB106	B106	Multi-Plus Belt
ERB108	B108	Multi-Plus Belt
ERB110	B110	Multi-Plus Belt
ERB112	B112	Multi-Plus Belt
ERB116	B116	Multi-Plus Belt
ERB118	B118	Multi-Plus Belt
ERB120	B120	Multi-Plus Belt
ERB124	B124	Multi-Plus Belt
ERB126	B126	Multi-Plus Belt
ERB128	B128	Multi-Plus Belt
ERB130	B130	Multi-Plus Belt
ERB131	B131	Multi-Plus Belt
ERB133	B133	Multi-Plus Belt
ERB136	B136	Multi-Plus Belt

ERP #	Reference	Belt Type
ERB140	B140	Multi-Plus Belt
ERB144	B144	Multi-Plus Belt
ERB150	B150	Multi-Plus Belt
ERB158	B158	Multi-Plus Belt
ERB162	B162	Multi-Plus Belt
ERB168	B168	Multi-Plus Belt
ERB173	B173	Multi-Plus Belt
ERB195	B195	Multi-Plus Belt
ERB23	5L260	Multi-Plus Belt
ERB24	5L270	Multi-Plus Belt
ERB25	5L280	Multi-Plus Belt
ERB26	5L290	Multi-Plus Belt
ERB27	5L300	Multi-Plus Belt
ERB28	5L310	Multi-Plus Belt
ERB29	5L320	Multi-Plus Belt
ERB30	5L330	Multi-Plus Belt
ERB31	5L340	Multi-Plus Belt
ERB32	5L350	Multi-Plus Belt
ERB33	5L360	Multi-Plus Belt
ERB34	5L370	Multi-Plus Belt
ERB35	5L380	Multi-Plus Belt
ERB36	5L390	Multi-Plus Belt
ERB37	5L400	Multi-Plus Belt
ERB38	5L410	Multi-Plus Belt
ERB39	5L420	Multi-Plus Belt
ERB40	5L430	Multi-Plus Belt
ERB41	5L440	Multi-Plus Belt
ERB42	5L450	Multi-Plus Belt
ERB43	5L460	Multi-Plus Belt
ERB44	5L470	Multi-Plus Belt
ERB45	5L480	Multi-Plus Belt
ERB46	5L490	Multi-Plus Belt
ERB47	5L500	Multi-Plus Belt
ERB48	5L510	Multi-Plus Belt
ERB49	5L520	Multi-Plus Belt
ERB50	5L530	Multi-Plus Belt
ERB51	5L540	Multi-Plus Belt
ERB52	5L550	Multi-Plus Belt
ERB53	5L560	Multi-Plus Belt
ERB54	5L570	Multi-Plus Belt
ERB55	5L580	Multi-Plus Belt
ERB56	5L590	Multi-Plus Belt
ERB57	5L600	Multi-Plus Belt
ERB58	5L610	Multi-Plus Belt
ERB59	5L620	Multi-Plus Belt

*\*Other belts available, please call for pricing*

ERP #	Reference	Belt Type
ERB60	5L630	Multi-Plus Belt
ERB61	5L640	Multi-Plus Belt
ERB62	5L650	Multi-Plus Belt
ERB63	5L660	Multi-Plus Belt
ERB64	5L670	Multi-Plus Belt
ERB65	5L680	Multi-Plus Belt
ERB66	5L690	Multi-Plus Belt
ERB67	5L700	Multi-Plus Belt
ERB68	5L710	Multi-Plus Belt
ERB69	5L720	Multi-Plus Belt
ERB70	5L730	Multi-Plus Belt
ERB71	5L740	Multi-Plus Belt
ERB72	5L750	Multi-Plus Belt
ERB73	5L760	Multi-Plus Belt
ERB74	5L770	Multi-Plus Belt
ERB75	5L780	Multi-Plus Belt
ERB76	5L790	Multi-Plus Belt
ERB77	5L800	Multi-Plus Belt
ERB78	5L810	Multi-Plus Belt
ERB79	5L820	Multi-Plus Belt
ERB80	5L830	Multi-Plus Belt
ERB81	5L840	Multi-Plus Belt
ERB82	5L850	Multi-Plus Belt
ERB83	5L860	Multi-Plus Belt
ERB84	5L870	Multi-Plus Belt
ERB85	5L880	Multi-Plus Belt
ERB86	5L890	Multi-Plus Belt
ERB87	5L900	Multi-Plus Belt
ERB88	5L910	Multi-Plus Belt
ERB89	5L920	Multi-Plus Belt
ERB90	5L930	Multi-Plus Belt
ERB91	5L940	Multi-Plus Belt
ERB92	5L950	Multi-Plus Belt
ERB93	5L960	Multi-Plus Belt
ERB94	5L970	Multi-Plus Belt
ERB95	5L980	Multi-Plus Belt
ERB96	5L990	Multi-Plus Belt
ERB97	5L1000	Multi-Plus Belt
ERB98	5L1010	Multi-Plus Belt
ERB99	5L1020	Multi-Plus Belt
ERBX50	BX50	Raw Edged Cogged Belt
ERBX51	BX51	Raw Edged Cogged Belt
ERBX53	BX53	FHP V-Belt
ERBX70	BX70	Raw Edged Cogged Belt

# AIR CONDITIONER ACCESSORIES

## SUPER SEAL

For professional use only: Always wear safety glasses and protective gloves. Use in compliance with the Montreal Protocol and Regional or Federal laws for the handling of refrigerant.

### Seals leaks from the inside out!

When you can't find the leak, Super Seal repairs leaks quickly, easily and permanently. Service techs save time & money on the first call without repeat calls.

- Compatible with all oils and refrigerants.
- Effective in sealing multiple leaks
- Hose and valve included with each product.
- Ideal for preventative maintenance too
- Vacuum packed can
- No flammable Hydro Carbons

Super Seal reacts with the present atmospheric moisture. As refrigerant starts to leak out, it lowers the ambient air down to the dew point. When this happens, little droplets of moisture appear around the leak area. When the sealant meets the moisture, it forms a low tensile crystalline structure that prevents further leakage. Super Seal is designed to seal leaks 300 microns or smaller.

**Order No. 944KIT** 1 unit  
**Order No. 944DIS** 8 units  
**Order No. 944CS** 12 units

#### Super Seal HVACR

- Repairs leaks in refrigerant units utilizing more than 4 lbs. of refrigerant
- Good for most residential systems
- 1-1/2 ton up to 5 ton (min. of 30 oz. of oil required)
- Will not clog the valve core when injected into the system
- Will not harm the compressor, windings or other components
- Won't interfere with compressor functions, valves, form wax or impede the lubrication ability of the system
- Compatible with all refrigerants & oils including 410a



**Order No. 947KIT** 1 unit  
**Order No. 947DIS** 8 units  
**Order No. 947CS** 12 units

#### Super Seal ACR

- Repairs leaks in refrigerant units utilizing less than 4 lbs. of refrigerant
- Good for smaller systems
- 230 BTUH up to 18000 BTUH (1-1/2 ton) (min. of 10 oz. of oil required)
- Will not clog the valve core when injected into the system
- Will not harm the compressor, windings or other components
- Won't interfere with compressor functions, valves, form wax or impede the lubrication ability of the system
- Compatible with all refrigerants & oils including 410a



**Order No. 946KIT** 1 unit  
**Order No. 946CS** 12 units

#### Super Seal Automotive

- Easily installed in minutes
- Professional strength formulation
- Permanently seals leaks in evaporators & condensers
- Effective in sealing multiple leaks
- Continues to circulate in the A/C system to prevent future leaks
- Contains no red dye
- Saves time, money & the environment from harmful emissions



**Order No. 973KIT**

#### ACR system application guidelines

- 230 BTUH / 0.067 KW to 18,000 BTUH / 5.3 KW: one can of Dry R
- 1.5 ton / 5.3 KW up to 5 ton / 17.6 KW: one can of Dry R (for micro leaks, add one can of Super Seal HVAC)

#### Dry R

- Eliminates moisture by pulling apart the H<sup>2</sup>O molecule and creates a stable environment
- Increases drier efficiency by turning yellow when moisture is present in the line, and back to green when the line is dry in 24 hours
- Prevents the formation of acid, as acid cannot form without moisture
- Can be used during or after maintenance is performed
- Excellent oil conditioner
- Can use with all Cliplight sealants (including sealants)
- Increases lifespan of AC/R units





# AIR CONDITIONER ACCESSORIES

## SUPER SEAL

### Order No. 979KIT

#### ACR system application guidelines

- 230 BTUH / 0.067 KW to 18,000 BTUH / 5.3 KW: one can of Dry R / for micro leaks add one can of Super Seal ACR
- 1.5 ton / 5.3 KW up to 5 ton / 17.6 KW: one can of Dry R / for micro leaks add one can of Super Seal ACR
- 5 ton / 17.8 KW and over: two cans of Dry R / for micro leaks add one can of Super Seal commercial

#### Super Seal Ultra Pack

- Dry and seal your system
- One kit will dry and seal A/C systems 1.5 ton up to 5 ton
- Remains stable over the life cycle of unit
- Installs in three easy steps...
  1. Install Dry R using direction provided
  2. Shut off unit and keep hose for step 3
  3. Install Super Seal using directions provided
- Both are compatible with CFC, HFC, & HCFC refrigerants and refrigeration oil
- Increases both efficiency and life span of AC/R unit
- Non corrosive, environmentally friendly, easy to use



### Order No. 971KIT *use on small systems*

### Order No. 972KIT *use on residential and/or commercial systems*

#### ACR system application guidelines

- 230 BTUH / 0.067 KW to 18,000 BTUH / 5.3 KW: one can of Super Seal Total 1
- 1.5 ton / 5.3 KW up to 5 ton / 17.6 KW: one can of Super Seal Total 2
- 5 ton / 17.8 KW and over: two cans of Super Seal Total 2

#### Super Seal Total 1 (971KIT)

#### Super Seal Total 2 (972KIT)

- For preventative maintenance
- Proactive- use before you have a leak
- Contains Super Seal Classic, Dry R and an Ultra Violet (UV) tracer dye
- Eliminate moisture and prevents acid formation
- Helps find larger leaks with use of UV tracer dye
- Compatible with all refrigerants and oils
- Remains stable over the life cycle of the unit
- Non corrosive and environmentally friendly



### Order No. WRAC

#### Universal Electrostatic Filter

- Trims to fit ALL window air conditioners up to 15" x 24"
  - Keeps air filtered and fresher
  - Washable & reusable
  - Last 3 years
- Replaces ALL9915*



### Order No. CC75

*Connects 3/4" Sch. 40, CPVC or 3/4" & 1" copper*

#### Condensate Drain Pipe Connector

- Fast & easy installation of condensate lines
- Ideal for units that use 3/4" or 1" PVC, CPVC or copper drain pipes
- 2-3/8" high
- Not for use in pressure or potable water applications



### Order No. EN1521 *12-15" H x 18-21" W*

### Order No. EN1725 *15-17" H x 22-25" W*

### Order No. EN2028 *18-20" H x 26-28" W*

#### Indoor Air Conditioner Cover

- Fits over your air conditioner on the inside to stop cold drafts
- Machine washable
- Small, medium & large sizes
- Made in the USA



### Order No. 0043 *(02140)*

*3 foot, 14/3, 15 amp, beige*

### Order No. 0044 *(02142)*

*6 foot, 14/3, 15 amp, beige*

### Order No. 0045 *(02144)*

*9 foot, 14/3, 15 amp, beige*

### Order No. 0046 *(02146)*

*12 foot, 14/3, 15 amp, beige*

#### Extension Cords

- Heavy duty vinyl insulation
- Right angle plugs
- 120 volt



### Order No. 0568 *(02157)*

#### Extension Cord

- 9 foot, 12/3, 20 amp, beige
- Heavy duty vinyl insulation
- Right angle plugs
- 250 volt





# INDEX

ERP #	PG #	ERP #	PG #	ERP #	PG#	ERP #	PG #	ERP #	PG #
0043.....	257	10QBP1004.....	134	13QBP23100.....	125	15QBP4166.....	143	22QBP104.....	138
0044.....	257	10QBP1005.....	133	13QBP24094.....	125	15QBP4184.....	143	22QBP117.....	138
0045.....	257	10QBP1006.....	133	13QBP25075.....	125	15QBP4185.....	143	22QBP121.....	138
0046.....	257	10QBP1009.....	133	13QBP25085.....	125	15QBP4186.....	143	22QBP128.....	138
00985.....	230	10QBP1012.....	133	13QBP25090.....	125	15QBP4204.....	143	22QBP144.....	138
010296.....	179	1125.....	235	13QBP25097.....	125	15QBP4227.....	143	22QBP152.....	138
010298.....	179	1126.....	235	1438.....	235	15QBP4228.....	143	22QBP169.....	138
010524.....	179	110071.....	179	1440.....	235	15QBP4235.....	143	22QBP184.....	138
0288.....	100	110074.....	179	1455.....	235	15QBP4237.....	143	22QBP192.....	138
0290.....	100	110087.....	180	14QBP25G5B20MM.....	130	16QBP0293.....	139	22QBP216.....	138
0291.....	100	110091.....	180	14QBP0100.....	152	16QBP0296.....	139	22QBP228.....	138
0293.....	100	110103.....	179	14QBP0101.....	152	16QBP4274.....	139	22QBP240.....	138
0294.....	100	110108.....	179	14QBP0105.....	152	16QBP4374.....	139	23QBP120H.....	138
0295.....	100	110110.....	180	14QBP0247.....	130	17QBP0260.....	151	23QBP120V.....	138
03063.....	180	110114.....	178	14QBP0248.....	130	17QBP2172.....	150	23QBP140V.....	138
03083.....	105	110117.....	178	14QBP0249.....	130	17QBP2971.....	150	23QBP143V.....	138
03091.....	180	110120.....	180	14QBP0250.....	130	1825.....	232	23QBP145V.....	138
03096.....	105	110128.....	178	14QBP0251.....	130	1860.....	232	23QBP150H.....	138
041000.....	230	110131.....	180	14QBP0252.....	130	1879.....	232	24200.....	231
0568.....	257	110133.....	178	14QBP04CSB20MM.....	130	18QBPO60V.....	140	25019.....	253
080402-B.....	160	110139.....	179	14QBP08CSB.....	130	18QBP077V.....	140	25QBP0513.....	127
09901.....	102	110144.....	178	14QBP10CFB.....	130	18QBP088H.....	140	25QBP0514.....	127
09902.....	102	110146.....	178	14QBP10CSB.....	130	18QBP090V.....	140	25QBP0521.....	127
09903.....	102	110161.....	179	14QBP10SC.....	130	18QBP090V-1.....	140	25QBP1550.....	127
09905.....	102	110165.....	180	14QBP12CFB.....	130	18QBP093H.....	140	25QBP3765.....	127
09906.....	102	110174.....	178	14QBP12CSB.....	130	18QBP094V.....	140	25QBP3770.....	127
09907.....	102	110175.....	178	14QBP15BAF.....	130	18QBP099H.....	140	25QBP3777.....	127
09908.....	102	110216.....	180	14QBP15BAN.....	130	18QBP110H.....	140	25QBP3778.....	127
09909.....	102	110222.....	180	14QBP15CFB.....	130	18QBP110H-1.....	140	25QBP3779.....	127
09911.....	101	110283.....	179	14QBP15CSB.....	130	18QBP110V-1.....	140	25QBP3780.....	127
09915.....	101	110284.....	179	14QBP15SC.....	130	18QBP115H-1.....	140	25QBP3784.....	127
09918.....	102	110497.....	178	14QBP18CFB.....	130	18QBP120H-W.....	140	25QBP3785.....	127
09919.....	102	110544.....	179	14QBP18CSB.....	130	18QBP121H.....	140	26QBP0029.....	118
09924.....	102	110642.....	179	14QBP20BAF.....	130	18QBP122V.....	140	26QBP0106.....	152
09936.....	102	110660.....	180	14QBP20BAN.....	130	18QBP122V-1.....	140	26QBP0177.....	119
1C.....	253	110661.....	180	14QBP20CFB.....	130	18QBP127H.....	140	26QBP0213.....	119
1T.....	253	110698.....	178	14QBP20CSB.....	130	18QBP135V.....	140	26QBP0239.....	119
10011WD.....	233	110885.....	179	14QBP20FLM.....	130	18QBP135V-1.....	140	26QBP0264.....	118
10124WD.....	233	116DA.....	233	14QBP20NLM.....	130	18QBP135V-1.....	140	26QBP0348.....	119
10140WD.....	232	11QBP0234.....	126	14QBP20NLM.....	130	18QBP138H.....	140	26QBP0542.....	118
10142WD.....	233	11QBP0235.....	126	14QBP20SC.....	130	18QBP145H.....	140	26QBP0544.....	118
10QBP0226.....	135	11QBP0236.....	126	14QBP25BAN.....	130	18QBP145V.....	140	26QBP0546.....	118
10QBP0227.....	135	11QBP0237.....	126	14QBP25CFB.....	130	18QBP149H.....	140	26QBP0930.....	118
10QBP0228.....	136	11QBP0526.....	126	14QBP25CSB.....	130	18QBP150H-W.....	140	26QBP0932.....	118
10QBP0229.....	134	11QBP0527.....	126	14QBP25NLM.....	130	18QBP160H.....	140	26QBP0936.....	118
10QBP0230.....	134	11QBP0528.....	126	14QBP30BAF.....	130	18QBP180V-1W.....	140	26QBP0938.....	118
10QBP0231.....	134	11QBP0529.....	126	14QBP30BAN.....	130	19010.....	160	26QBP10002.....	119
10QBP0232.....	135	11QBP0530.....	126	14QBP30CFB.....	130	19500.....	159	26QBP10007.....	119
10QBP0234.....	135	11QBP0531.....	126	14QBP30CSB.....	130	1999.....	235	26QBP10021.....	119
10QBP0235.....	134	11QBPUNIV.....	126	14QBP30FLM.....	130	21872A16.....	253	26QBP1108.....	118
10QBP0238.....	135	13350.....	160	1518C.....	106	21QBP084V.....	138	26QBP1109.....	118
10QBP0239.....	135	133AR.....	233	1518DIS.....	106	21QBP098V.....	138	26QBP1110.....	118
10QBP0243.....	135	13QBP20075.....	125	1518G.....	106	21QBP109V-1.....	138	26QBP1119.....	118
10QBP0246.....	134	13QBP21055.....	125	1518GC.....	106	21QBP110V.....	138	26QBP1121.....	118
10QBP0249.....	135	13QBP21065.....	125	15QBPO111.....	142	21QBP117V.....	138	26QBP1125.....	118
10QBP0259.....	134	13QBP21080.....	125	15QBP0122.....	142	21QBP121V-1.....	138	26QBP1316.....	116
10QBP0275.....	134	13QBP21085.....	125	15QBP0192.....	142	21QBP128V.....	138	26QBP3236.....	118
10QBP0300.....	136	13QBP21090.....	125	15QBP0451.....	142	21QBP144V-1.....	138	26QBP4033.....	118
10QBP0309.....	136	13QBP21090-1.....	125	15QBP0685.....	142	21QBP152V.....	138	26QBP4059.....	118
10QBP0311.....	136	13QBP21095.....	125	15QBP0851.....	142	21QBP152V-1.....	138	26QBP4061.....	118
10QBP0315.....	136	13QBP21095-1.....	125	15QBP1017.....	142	22QBP072.....	138	26QBP4062.....	118
10QBP1000.....	133	13QBP21097.....	125	15QBP1344.....	142	22QBP077.....	138	26QBP4074.....	118
10QBP1001.....	133	13QBP21100.....	125	15QBP3596.....	142	22QBP084.....	138	26QBP4076.....	118
10QBP1003.....	133	13QBP21105.....	125	15QBP3932.....	142	22QBP093.....	138	26QBP4079.....	118
10QBP1003K.....	133	13QBP21110.....	125	15QBP4118.....	143	22QBP098.....	138	26QBP4082.....	119

# INDEX

ERP #	PG #	ERP #	PG #	ERP #	PG #	ERP #	PG #	ERP #	PG #
26QBP4085	118	30QBP2278	146	580500	239	6237	109	80QBP0723	149
26QBP4087	118	30QBP2375	147	58128	105	6238	109	80QBP0761	149
26QBP4090	118	30QBP2415	146	58129	105	6240	110	80QBP0787	128
26QBP4091	119	30QBP2418	147	590441	238	6241	110	80QBP0827	129
26QBP4092	119	30QBP2525	146	6057	177	6242	110	80QBP0895	149
26QBP4093	118	30QBP2567	147	6101	109	6243	109	80QBP0898	149
26QBP4094	118	30QBP2782	147	6102	109	6244	109	80QBP0992	110
26QBP4395	119	30QBP3019	146	6103	109	6245	109	80QBP1021	144
28QBP0491	137	30QBP3031	147	6104	109	6246	109	80QBP1110	144
28QBP0492	137	30QBP3538	147	6105	109	6247	109	80QBP1137	107
28QBP0493	137	30QBP3675	146	6106	109	6248	109	80QBP1139	109
28QBP0494	137	30QBP4026	147	6107	109	6250	110	80QBP1144	109
28QBP0495	137	30QBP4087	147	6108	109	6251	110	80QBP1146	107
28QBP0496	137	30QBP4099	147	6109	109	6252	109	80QBP1175	129
28QBP0497	137	30QBP4107	147	6110	109	6253A	109	80QBP1219	144
28QBP0498	137	30QBP4110	146	6111	109	6254	109	80QBP1220	151
28QBP0499	137	30QBP4111	146	6112	109	6255	109	80QBP1287	144
28QBP0500	137	30QBP4117	146	6113	110	6256	110	80QBP1352	141
28QBP0501	137	30QBP4119	147	6114	110	6257	109	80QBP1361	107
28QBP0502	137	30QBP4124	146	6115	110	6258	109	80QBP1362	107
28QBP0503	137	30QBP4126	147	6120	109	6261	110	80QBP1376	109
28QBP0504	137	30QBP4143	146	6121	109	6262	110	80QBP1418	108
28QBP0505	137	30QBP4145	146	6123	109	6263	110	80QBP1421	150
28QBP0506	137	30QBP4160	146	6124	110	6264	109	80QBP1432	150
28QBP0507	137	30QBP4163	147	6125	110	6265	109	80QBP1446	108
28QBP0540	137	30QBP4185	146	6126	110	6266	110	80QBP1468	151
28QBP0541	137	30QBP4630	147	6127	110	6267	110	80QBP1496	150
28QBP0546	137	31316	160	6128	110	6268	110	80QBP1602	144
28QBP0610	137	32025	236	6129	110	6271	109	80QBP1771	141
28QBP0839	137	325D	231	6131	109	6272	110	80QBP1781	141
28QBP0841	137	3409	110	6132	110	6273	110	80QBP1796	107
29QBP0478	148	3500PT	232	6133	110	6274	110	80QBP2031	107
29QBP1951	148	390D	231	6134	109	6275	110	80QBP2193	141
29QBP2569	148	4ARMC	234	6136	109	6276	110	80QBP2524	128
29QBP4093	148	4ARMCTRC	234	6139	110	6280	110	80QBP2621	128
3BT	253	4EP	249,251	6140	109	66BR	231	80QBP2671	128
3000PT	232	40QBP0461	148	6141	109	68571	231	80QBP2699	128
301	230	40QBP0480	148	6142	109	69375	233	80QBP2804	128
302U	231	40QBP0482	148	6143	109	6HB	249-252	80QBP2831	144
304D	231	40QBP0484	148	6144	109	7000PT	232	80QBP3112	141
308D	231	40QBP0485	148	6145	110	7301	110	80QBP3117	150
30QBP0041	147	40QBP0715	148	6147	109	73238	236	80QBP3119	150
30QBP0055	147	40QBP0720	148	6148	110	73239	236	80QBP3142	144
30QBP0057	146	40QBP0737	148	6149	110	73276	236	80QBP3199	144
30QBP0064	147	40QBP0739	148	6150	110	73611	237	80QBP3483	150
30QBP0254	146	40QBP1012	148	6151	110	7501	110	80QBP3644	144
30QBP0331	147	40QBP1155	148	6155	109	7502	110	80QBP3689	144
30QBP0349	147	40QBP1399	148	6160	109	7503	110	80QBP3728	109
30QBP0350	147	40QBP1618	148	6207	109	7504	110	80QBP3931	151
30QBP0566	147	40QBP1706	149	6208	110	7505	110	80QBP4011	144
30QBP0604	147	40QBP3849	149	6209	109	7506	110	80QBP4019	129
30QBP0649	146	40QBP4144	149	6219	110	7507	110	80QBP4039	141
30QBP0663	147	40QBP4189	149	6222	110	7508	110	80QBP7139	144
30QBP0766	147	40QBP4197	149	6223	110	7509	110	80QBP7160	145
30QBP0793	146	40QBP4200	149	6224	110	7510	110	80QBP7161	145
30QBP0901	147	40QBP4201	149	6225	110	7511	110	80QBP7370	129
30QBP1000	147	40QBP4203	149	6226	110	7512	110	80QBP7371	129
30QBP1002	146	4245	235	6227	109	7515	110	80QBP7373	129
30QBP1111	146	4250	235	6228	109	7521	110	80QBP7638	128
30QBP1145	146	4750	152	6229	109	7522	110	80QBP7677	150
30QBP1252	146	5011509	232	6231	110	7535304360	231	80QBP8240	151
30QBP1274	146	50332015	232	6232	109	77801	232	80QBP8337	151
30QBP1768	146	50333025	232	6233	109	79770	236	80QBP8387	141
30QBP1848	146	50334010	105	6235	109	80242	231	80QBP8541	145
30QBP2198	147	5107	110	6236	109	80QBP0571	141	80QBP8568	141

# INDEX

ERP #	PG #	ERP #	PG #	ERP #	PG#	ERP #	PG #	ERP #	PG #
80QBP8588	128	8193	109	8517	108	85QBP0107	108	D14-C	249,251
80QBP8598	145	8194	108	8518	108	8724	108	D18-C	249,251
80QBP8609	145	8196	108	8519	107	875G	195	D19-C	252
80QBP8633	145	8201	107	8520	107	88777	236	D88	249,251
80QBP8654	145	8212	107	8521	108	944CS	256	DA75610	236
80QBP8658	129	8213	107	8522	107	944DIS	256	DA75620	236
80QBP8668	129	8222	110	8523	107	944KIT	256	DA75630	236
80QBP8675	151	8223	110	8525	107	946CS	256	DA76070	237
80QBP8676	141	8224	110	8526	108	946KIT	256	DA76080	237
80QBP8677	129	82361	231	8528	108	947CS	256	DA76090	237
80QBP8680	128	8241	107	8529	107	947DIS	256	DA76110	237
80QBP8695	141	82774	236	8530	109	947KIT	256	DA76150	238
80QBP8701	145	82QBP0102	150	8531	108	9701B1647	103	DA76190	238
80QBP8712	151	82QBP0117	150	8532	107	9701B1648	103	DA76370	237
80QBP8715	129	8302	107	8534	107	9701B1649	103	DA76410	238
80QBP8717	145	8303	107	8535	108	9701B1650	103	DA76440	236
80QBP8723	145	8304	108	8536	108	9701B1654	103	DA76450	236
80QBP8750	151	8305	108	8537	108	9701B1655	103	DA76470	238
80QBP8786	141	8306	108	8538	107	9701B1656	103	DA76570	235
80QBP8817	150	8307	108	8539	107	9701B1661	103	DA78200	237
80QBP8819	145	8308	108	8540	108	9701B1669	103	DA84000	238
80QBP8834	128	8309	108	8541	108	971KIT	257	DA84140	238
80QBP8929	145	8310	108	8542	108	972KIT	257	DA84150	238
80QBP9011	141	8311	107	8543	108	973KIT	256	DA84200	238
80QBP9083	107	8312	107	8545	108	979KIT	257	DA86370	236
8103	108	8313	108	8546	109	980068H04	103	DA86420	237
8105	107	8321	107	8547	107	986752H02	103	DB6GE	24
8106	108	8322	108	8548	107	98QBP0300	235	DB6GE1	24
8107	108	8323	108	8553	109	98QBP0301	235	DB6GE2	24
8108	108	8324	108	8555	109	98QBP0302	235	DB6WE	24
8130	107	8325	108	8557	108	98QBP0303	235	DB6WH	25
8140	107	8326	108	8558	107	98QBP0928	136	DB6WHP	25
8141	107	8327	107	8561	108	98QBP0929	136	DB8GE	24
8143	107	8328	107	8562	109	9968QL	235	DB8GE1	25
8146	107	8329	108	8564	108	A10	249-251	DB8GE2	25
8147	107	8330	108	8565	109	A12	249,251,252	DB8WE	24
8148	107	83304	236	8566	109	A20	249,251	DB8WH	25
8150	107	8341	108	8568	109	A35	249,251,252	DB8WHP	25
81504	231	8342	108	8569	107	A-4101	253	DBU6	24
8153	108	8343	108	8570	107	A97	249	DBU6P	24
8154	107	8344	108	8571	107	AB412	177	DBU8	24
8156	107	8345	108	8572	107	ALL1	249-252	DBU8P	24
8158	107	8346	108	8577	107	ALL2	250-252	DC12N	160
8160	108	8347	108	8579	107	ALL3	250-252	DE32N	160
8161	108	8348	108	8580	109	ALLE-04	195	DM06N	159
8162	108	8349	108	8581	109	AP177	235	DM12D	159
8163	107	8350	108	8582	107	APPL-CVR	195	DM24F	159
8164	107	83QBP1516	151	8583	107	B108C	234	DP06NPB	160
8166	108	85-011	234	8585	108	B-24	253	DP424F	160
8167	107	8501	109	8586	108	B241C	194	DP46TPB	160
8168	107	8502	107	8588	107	B295C	194	DP6GE	25
8169	107	8503	107	8589	108	B304C	194	DP8GE	25
8170	107	8504	107	8590	107	B36C	160	DPU6	24
8172	107	8505	107	8591	108	B40-C	249	DPU8	24
8173	107	8506	107	8592	108	B42C	234	DU3-C	249,251
8174	108	8507	107	8593	108	B47C	230	DVC202	177
8175	109	8508	107	8594	108	B68C	177,194	DVDEMO	177
8176	107	8509	109	8595	107	B81C	177,194	DVDREF1	230
8180	108	8510	107	8596	108	CB41	249	DVDREF1-S	230
8181	108	8511	107	8597	108	CB43	249	DVDREF2	230
8182	108	8512	107	8598	107	CB45	249	DVDREF2-S	230
8185	108	8513	107	8599	109	CBW9	249	DWDH78	158
8186	108	8514	108	85QBP0101	109	CC75	257	DWIP72	158
8187	108	8515	107	85QBP0103	108	D09-C	249,251	DWR-B	159
8192	109	8516	107	85QBP0104	109	D13-C	249,251,252	DWR-GY	159

# INDEX

ERP #	PG #	ERP #	PG #	ERP #	PG #	ERP #	PG #	ERP #	PG #
DWR-W	159	ER12002744	215	ER1474052P	246	ER1802167	98	ER216016K	186
E27-50	119	ER12002782	226	ER154174501	153	ER1802168	98	ER216201	187
E27-75	119	ER12005	103	ER154637401	153	ER1805D130	77	ER2163631	205
E2R	250,251	ER12400034	68	ER154665201	153	ER1805D129	77	ER2167	17
ED4	250-252	ER1250	53	ER1566267	67	ER1805D135	77	ER2168	17
EF1	250,251	ER1254	57	ER15A15	116	ER1805D137	77	ER2169373	228
EF2	250,251	ER1255	53	ER15T6	117	ER1805D141	77	ER218027022	204
EN1521	257	ER12550101Q	220	ER15T7C	116	ER1805F222	105	ER2183139	207
EN1725	257	ER12550109Q	220	ER15T7DC	117	ER1805F223	105	ER2183140	207
EN2028	257	ER12550111Q	220	ER15T7N	117	ER1805F224	105	ER2183141	207
EP2002	247	ER12550112Q	220	ER15T8	117	ER1805F225	105	ER2183400	212
EP2003	247	ER12550115Q	220	ER15T8E14	117	ER1832371	57	ER2187145	227
EP2004	247	ER12550116Q	220	ER16300	194	ER1841L61	26	ER2187172	206
EP2005	247	ER12555902	227	ER16301	194	ER1841L62	26	ER218730601	219
EP2006	247	ER1285	65	ER18001	40	ER1842A18	15	ER218730603	219
EP2007	247	ER13002	95	ER18007	36	ER1842A40	77	ER218730604	219
EPT	250	ER131476300	163	ER18008	36	ER1842A54	15	ER218730605	219
ER0052750	36	ER131686100	181	ER18009	36	ER1842A57	15	ER218730606	219
ER0057299	86	ER131689300	163	ER18014	32	ER1842A58	77	ER218730609	219
ER0057300	86	ER131689400	182	ER18015	32	ER1842A59	15	ER218730610	219
ER0060218743	201	ER131825900	162	ER1801A133	52	ER1842A60	78	ER2188404A	220
ER0088640	104	ER131873500	163	ER1801A152	56	ER1845D33	78	ER2188405A	220
ER01167943	162	ER134011703	163	ER1801A153	56	ER1845D40	78	ER2188433A	219
ER02527773700	247	ER134034911	163	ER1801A157	52	ER1845D41	78	ER2188433A	220
ER02532625000	244	ER134034971	163	ER1801A165	56	ER1845G66	103	ER2188434A	219
ER03011	53	ER134042700	182	ER1801A166	52	ER18806	229	ER2188434A	220
ER03018	53	ER134051000	181	ER1801A167	52	ER197	174	ER2188435A	220
ER0310245	53	ER134051003	181	ER1801A203	52	ER2001	220	ER2188436A	220
ER0310647	53	ER134101800	182	ER1801A291	61	ER2002	220	ER2188438A	220
ER04008	62	ER134196600	164	ER1801B145	43	ER2003	220	ER2188439A	220
ER07515700	86	ER134719300	161	ER1801B178	45	ER2004	220	ER2188442A	220
ER07519400	36	ER134844410	163	ER1801B183	45	ER204013	188	ER2188444A	220
ER0A4298K	188	ER134844412	163	ER1801B184	45	ER205000	189	ER2188445A	220
ER1000	247	ER134844413	163	ER1801M53	34	ER205613	190	ER2188446A	220
ER1003	247	ER134844470	163	ER1801M54	34	ER206154	187	ER2188447A	220
ER1010A	159	ER134886700	163	ER1801M58	34	ER206638K	186	ER2188448A	220
ER1010B	159	ER137115900	164	ER1801M59	34	ER20T61/2	117	ER2188450A	220
ER10359708Q	220	ER137292700	161	ER1801M71	41	ER21001906	186	ER2188451A	220
ER10359709Q	220	ER1398	35	ER1802A155	64	ER21002240	186	ER2188456A	220
ER1090	243	ER1399	35	ER1802A206	64	ER211124	181	ER2188458A	220
ER1090N	243	ER1401	244	ER1802A207	56	ER211124/25K	189	ER2188460A	220
ER10C7	116	ER1401N	244	ER1802A223	56	ER211125	181	ER2188461A	220
ER10C7DC	116	ER1402	244	ER1802A241	61	ER2-12989	187	ER2188462A	220
ER1056120	116	ER1402N	244	ER1802A247	77	ER2-13013	187	ER2188463A	220
ER1056230	116	ER1403	244	ER1802A248	77	ER213015	187	ER2188829	227
ER1056DC	116	ER1403N	244	ER1802A290	61	ER21352320	181	ER2188830	227
ER1123394	203	ER1404	36	ER1802A295	77	ER214765	186	ER218969902	211
ER1129252	220	ER1404	244	ER1802A298	64	ER215019101	219	ER2191880	207
ER1192	61	ER1405	36	ER1802A302	68	ER215019102	219	ER2191881	207
ER1193	61	ER1405	244	ER1802A305	68	ER215019103	219	ER2191883	207
ER1194	61	ER1405N	245	ER1802A319	61	ER215019104	219	ER2198202	203
ER1195	61	ER1406	245	ER1802A326	67	ER215019105	219	ER2198597	196
ER12001541	169	ER1406N	245	ER1802A331	77	ER215019106	219	ER2198597RK	196
ER12001594	47	ER1407	245	ER1802A332	77	ER2-15234	187	ER22003483	181
ER12001596	47	ER1407N	245	ER1802A333	77	ER2-15235	187	ER22004073	190
ER12001655	73	ER1408	245	ER1802A342	77	ER215267701	206	ER22004189	190
ER12001656	73	ER1408N	245	ER1802A343	77	ER215366002	204	ER22004323	190
ER12001676	20	ER1409	245	ER1802G35	94	ER215366074	204	ER22004380	190
ER12001677	187	ER1409N	245	ER1802G38	94	ER2-15447	187	ER2204	220
ER12001788	181	ER1410	245	ER1802G39	94	ER215473602	206	ER2213	220
ER12002	103	ER1410N	246	ER1802I44	98	ER215732415	219	ER2217220	197
ER12002121	28	ER1411	246	ER1802I45	98	ER215740402	219	ER22213057	187
ER12002125	28	ER1411N	246	ER1802I56	98	ER215846602	212	ER2225929	226
ER12002279	54	ER1412	246	ER1802I65	98	ER2159057	220	ER2262080	220
ER12002724	65	ER1412N	246	ER1802I66	98	ER2159061	220	ER2262081	220

# INDEX

ERP #	PG #	ERP #	PG #	ERP #	PG #	ERP #	PG #	ERP #	PG #
ER2263749	209	ER279264	176	ER314096	58	ER316270200	73	ER3399849	174
ER2286	28	ER279311	170	ER3148952	28	ER316270201	73	ER34001269	190
ER2287	28	ER279347	175	ER3149400	28	ER316279400	61	ER34001302	191
ER2301	220	ER279347	189	ER3149404	28	ER316436000	26	ER34001320	186
ER2302	220	ER279393	175	ER3149983	86	ER316436001	26	ER34001324	190
ER2303	220	ER279408	176	ER3149984	86	ER318016209	80	ER34001411	181
ER2304	220	ER279570	165	ER3149986	86	ER318016823	80	ER3405281	175
ER2319263T	220	ER279570	175	ER3149987	86	ER318059206	68	ER3406105	175
ER2319264T	220	ER279570M	175	ER3149988	86	ER318087100	52	ER3406107	175
ER2319265T	220	ER279640	169	ER316007002	97	ER318087200	64	ER341241	161
ER2319266T	220	ER279735	176	ER316009008	78	ER318099100	80	ER3412A00419	40
ER2325700	203	ER279769	173	ER316009107	78	ER318196201	80	ER343	194
ER239087	176	ER279787	170	ER316009113	78	ER3182567	86	ER349241	169
ER240311501	207	ER279816	174	ER316009115	78	ER3185830	58	ER349241T	169
ER240311502	207	ER279827	170	ER316009117	78	ER3186209	37	ER349639	172
ER240323001	206	ER279838	171	ER316016819	78	ER3186213	37	ER34FHT	156
ER240323002	206	ER280187	186	ER316023009	79	ER3186214	37	ER35001010	161
ER240331401	204	ER285134	191	ER316023020	79	ER3186215	37	ER35001092	173
ER240331404	204	ER285206	187	ER316023023	79	ER3186576	48	ER35001150	171
ER240331405	204	ER285317	186	ER316025106	79	ER318984-753	247	ER35001191	174
ER240331407	204	ER285587	190	ER316025108	79	ER3191731	41	ER350365	186
ER240331501	207	ER285671	189	ER316028600	15	ER3191901	41	ER35-0425	181
ER240331502	207	ER285744	189	ER316029008	79	ER3191903	41	ER356402	161
ER240331UNIV	205	ER285748	187	ER316032000	56	ER3196027	86	ER356934	188
ER240331UNIVKIT	205	ER285753	188	ER316032001	56	ER3196113	73	ER359449	188
ER240369701	214	ER285753A	188	ER316032411	68	ER3196213	86	ER3804FE	193
ER240383703	202	ER285785	189	ER316035200	56	ER3196214	87	ER3804FF	193
ER241586503	202	ER285790	190	ER316035201	56	ER3196231	87	ER3804MF	193
ER241675701	197	ER285792	190	ER316039002	34	ER3196232	87	ER3805FE	193
ER241854703	197	ER285811	187	ER316039003	34	ER31962701	48	ER3805FF	193
ER241696605	214	ER285852	188	ER316051400	104	ER3196803	17	ER3806FE	193
ER241734302	198	ER28808	181	ER316051401	104	ER3200539	78	ER3806FF	193
ER241803701	198	ER3016158	94	ER316055800	32	ER32020101	48	ER3806MF	193
ER241809402	212	ER3018432	32	ER316057100	40	ER3203459	64	ER3808FE	193
ER241854301	214	ER303373K	169	ER316067902	94	ER3204880	78	ER3808FF	193
ER241854401	214	ER303395	173	ER316081701	43	ER3206150	206	ER3810FF	193
ER241872501	219	ER303396	173	ER316081705	43	ER3206165	206	ER3812FF	193
ER241872502	219	ER303404	171	ER316088900	32	ER3206166	206	ER3815FF	193
ER241872503	219	ER303650	157	ER316102300	79	ER33001003	172	ER383727	188
ER241872504	219	ER303705	169	ER316102303	79	ER33001808	172	ER3934700	181
ER241872507	219	ER303836	170	ER316102304	79	ER33002535	161	ER3949238	189
ER241872509	219	ER306508	176	ER316102306	79	ER33002803	176	ER3949247	189
ER241872510	219	ER307458	86	ER316103800	34	ER33002808	176	ER3956905	191
ER241872511	219	ER308034E0136	43	ER316103801	34	ER33002854	176	ER3957749	191
ER241872512	219	ER308034E0148	43	ER316108902	79	ER33002855	176	ER3968381	188
ER241872513	219	ER308034E0158	43	ER316108917	79	ER33002970	172	ER3977767	173
ER241872514	219	ER308035E0160	43	ER316109002	79	ER330190	87	ER3L150	254
ER241993001	229	ER308125A01	43	ER316109003	79	ER33313541	176	ER3L160	254
ER2-4660K	187	ER308150F0246	43	ER316109512	79	ER3348552	187	ER3L170	254
ER25A15	116	ER308150F0429	43	ER316109514	79	ER3362624	190	ER3L180	254
ER25T6	117	ER308171A01	43	ER316109515	80	ER3363394	186	ER3L190	254
ER25T61/2	117	ER308196E0120	43	ER316114600	15	ER3363892	186	ER3L200	254
ER25T61/2DC	117	ER308196E0166	43	ER316123303	80	ER3364290	190	ER3L210	254
ER25T7DC	117	ER308272E01	43	ER316123304	80	ER3364291	191	ER3L220	254
ER25T7N	117	ER309563B	86	ER316135702	46	ER337019	161	ER3L230	254
ER25T8	117	ER31001043	170	ER316213500	41	ER337388	161	ER3L240	254
ER25T8DC	117	ER31001096	169	ER316213501	41	ER3376846	156	ER3L250	254
ER25T8N	117	ER31001556	170	ER316215901	16	ER3387134	173	ER3L260	254
ER2-6680K	187	ER311012	161	ER316220002	80	ER3387747	171	ER3L270	254
ER27001	57	ER311013	161	ER316220009	80	ER338906	175	ER3L280	254
ER27001006	181	ER312544	161	ER316233902	73	ER3390291	173	ER3L290	254
ER27001007	181	ER312948	170	ER316238200	26	ER3390719	174	ER3L300	254
ER27009	57	ER312959	161	ER316239700	98	ER3392519	174	ER3L310	254
ER27045	72	ER3131202	78	ER316240700	80	ER339392	172	ER3L320	254
ER27155	181	ER313328	161	ER316240802	80	ER3394652	161	ER3L330	254

# INDEX

ERP #	PG #	ERP #	PG #	ERP #	PG #	ERP #	PG #	ERP #	PG #
ER3L340	254	ER4364462	95	ER5301124534	219	ER5303311539	94	ER5500212	30
ER3L350	254	ER4364472	97	ER5301321001	32	ER5303323278	82	ER5500234	30
ER3L360	254	ER4371476	87	ER5301EL1001G	165	ER5303324302	206	ER5500235	30
ER3L370	254	ER4371492	87	ER5303001317	219	ER5303912606	46	ER5500287	29
ER3L380	254	ER4371663	87	ER5303009309	32	ER5303918202	211	ER5502350	29
ER3L390	254	ER4372287	87	ER5303015714	94	ER5303918277	196	ER5502404	30
ER3L400	254	ER4372386	87	ER5303051028	80	ER5303918344	196	ER56095	161
ER3L410	254	ER4372439	95	ER5303051030	80	ER5303918549	214	ER56595-3	199
ER3L420	254	ER437367	161	ER5303051069	98	ER5303935025	41	ER5800S0001	65
ER3L430	254	ER4387489	211	ER5303051079	103	ER5303935128	52	ER581035D0178	103
ER3L440	254	ER4387490	211	ER5303051405	80	ER5303937139	164	ER581241A01	103
ER3L450	254	ER4387565	220	ER5303131018	80	ER5303937182	164	ER5817S0007	64
ER3L460	254	ER4387590	220	ER5303131079	35	ER5303937183	164	ER5817S0009	65
ER3L470	254	ER4387604	220	ER5303131080	35	ER5304402687	206	ER5817S0010	65
ER3L480	254	ER4387626	220	ER5303161099	161	ER5304402688	206	ER5817S0011	66
ER3L490	254	ER4387913	226	ER5303161103	164	ER5304403828	219	ER60065	57
ER3L500	254	ER4389102	197	ER5303200810	202	ER5304404033	219	ER600BLADE	242
ER3L510	254	ER4389142	215	ER5303201275	103	ER5304404034	219	ER6010619	209
ER3L530	254	ER4389144	215	ER5303202011	98	ER5304404035	219	ER6010634	209
ER3L560	254	ER4389145	215	ER5303204154	35	ER5304404036	219	ER6010635	209
ER3L580	254	ER4390515	212	ER5303204155	35	ER5304404037	219	ER60140	53
ER3L610	254	ER4390530	220	ER5303204670	97	ER5304404821	202	ER60141	57
ER3V355	254	ER4390587	203	ER5303204672	97	ER5304421067	202	ER607335	158
ER3V710	254	ER4391960	171	ER5303207229	206	ER5304421256	202	ER60A15	116
ER3V830	254	ER4392065	170	ER5303207230	206	ER5304455657	109	ER60A15BT	116
ER3V850	254	ER439490	181	ER5303207345	219	ER5304457303	16	ER60J00	247
ER40111201	161	ER4396508	200	ER5303211140	80	ER5304464438	228	ER61001846	209
ER40A15	116	ER4396510	200	ER5303212849	164	ER53-0701	172	ER61001874	209
ER40A15CLR	116	ER4396701	200	ER5303261151	181	ER5307510058	219	ER61001898	227
ER40R14	117	ER4455523	97	ER5303261153	181	ER53-0771	173	ER61001946	209
ER40T10	117	ER4455524	97	ER5303270406	227	ER5308001832	181	ER61001962	205
ER40T10F	117	ER4455525	97	ER5303271670	81	ER5308002385	182	ER61001963	205
ER40T61/2	117	ER4455526	97	ER5303272274	32	ER5308007123	219	ER61001964	205
ER4157094	65	ER4456027	28	ER5303272301	81	ER5308007124	219	ER61001965	205
ER4157180	58	ER4581EL2002A	165	ER5303276826	219	ER5308008362	64	ER61002112	207
ER4162321	156	ER482468	215	ER5303279394	182	ER5308009419	65	ER61002399	205
ER4162322	156	ER482469	216	ER5303280326	181	ER5308013889	82	ER61002400	205
ER4163075	156	ER482493	212	ER5303281049	164	ER5308013896	82	ER61002992	211
ER4168745	58	ER482731	216	ER5303281153	165	ER5308013898	82	ER61003998	220
ER4173112	58	ER491680	181	ER5303281154	161	ER5308013926	68	ER61003999	220
ER4179282	87	ER49621	189	ER5303281481	204	ER5308013927	61	ER61004002	220
ER4179304	87	ER4C7	116	ER5303284616	103	ER5308015762	202	ER61004003	220
ER4179305	87	ER4L170	254	ER5303284698	81	ER5308057424	161	ER61004006	220
ER4204490	200	ER4L180	254	ER5303285718	104	ER53-0918	172	ER61004007	220
ER422244	182	ER505797P	176	ER5303285720	32	ER53-1096	173	ER61004008	220
ER422245	182	ER510342	220	ER5303285724	81	ER53-1182	174	ER61004888	216
ER425458	158	ER510343	220	ER5303285939	81	ER5318680302	219	ER61005254	211
ER4315513	87	ER510344	220	ER5303285940	81	ER536250006	62	ER61005273	199
ER4315516	87	ER510345	220	ER5303288190	52	ER5390S0018	62	ER61005518	226
ER4317943	196	ER5220FR2006H	182	ER5303288194	81	ER5394S0021	62	ER61005604	229
ER4317943L	196	ER5220FR2008F	182	ER5303288238	219	ER5396S0012	62	ER61005626	199
ER4318046	198	ER5221DD1001A	158	ER5303288856	219	ER5414S0109	67	ER61005789	203
ER4318047	198	ER5221ER1003A	182	ER5303288973	229	ER5414S0308	67	ER61005935	216
ER4327244	87	ER5231JA2002A	201	ER5303297131	81	ER5415H0101	67	ER61005988	212
ER4330739	58	ER5231JA2006A	200	ER5303297557	219	ER545072E01-51	72	ER61006022	226
ER4332487	32	ER5231JA2006B	200	ER5303300237	204	ER545073E01-48	72	ER61006072	203
ER4332720	54	ER525	194	ER5303302473	81	ER545088E01-24	72	ER61006116	209
ER4333718	65	ER528919	220	ER5303303405	81	ER5450S0073-LH	72	ER61006198	209
ER4333767	87	ER5300007880	61	ER5303303406	81	ER5450S0073-RH	72	ER61006199	210
ER4334809	95	ER5300158289	214	ER5303303408	81	ER545120E01-37	72	ER61006294	227
ER4335161	37	ER5300622032	164	ER5303303673	81	ER5500134	30	ER61927	171
ER4343449	220	ER5300622034	164	ER5303304242	81	ER5500200	26	ER622266992	246
ER4344040	227	ER5300622451	181	ER5303304506	81	ER5500200M	26	ER6251MW	85
ER4364072	97	ER5300628042	219	ER5303305604	81	ER5500202	29	ER6253	85
ER4364210	95	ER5300809703	153	ER5303309874	219	ER5500203	30	ER6255	85



# INDEX

ERP #	PG #	ERP #	PG #	ERP #	PG #	ERP #	PG #	ERP #	PG #
ER6255W	85	ER7212P001-60	99	ER7711P31460	89	ER8544742	161	ERA33	254
ER627985	197	ER7212P002-60	99	ER7711P39460	89	ER8544771	171	ERA34	254
ER6280MW	85	ER7212P043-60	99	ER7728	98	ER8547157	161	ERA35	254
ER628366	197	ER730110	43	ER7731P01360	89	ER8547168	161	ERA36	254
ER6284	85	ER7331	78	ER7731P04060	89	ER8557882	172	ERA37	254
ER6286	85	ER74001086	32	ER7731P09460	89	ER8557884	172	ERA38	254
ER6286W	85	ER74002352	88	ER7733P01460	89	ER8562613	181	ERA39	254
ER6376	85	ER74002353	88	ER7733P01560	89	ER8577274	174	ERA40	254
ER6376W	85	ER74002390	68	ER7733P02760	89	ER876480	220	ERA41	254
ER64208	189	ER74002444	88	ER7733P06260	89	ER876483	220	ERA42	254
ER6476	86	ER74002445	88	ER7733P072-60	89	ER883149	110	ERA43	254
ER6476W	86	ER74003122	28	ER7739P048-60	89	ER883151	110	ERA44	254
ER6513S0001	46	ER74003280	88	ER786130	59	ER902115	161	ERA45	254
ER6520G0601	46	ER74003296	88	ER786235	107	ER902115	181	ERA46	254
ER6520S0201	46	ER74003297	88	ER786333	25	ER903758	246	ERA47	254
ER653209	220	ER74003299	37	ER78821	109	ER91939	188	ERA48	254
ER6540S0001	47	ER74003300	37	ER7C7	116	ER93553	188	ERA49	254
ER6542S0001	47	ER74003332	40	ER7C7DC	116	ER93770	191	ERA50	254
ER6544S0001	47	ER74003712	88	ER80040	188	ER95405	181	ERA51	254
ER6545S0001	47	ER74003713	88	ER80040D	188	ER97012038	240	ERA52	254
ER6547S0001	47	ER74003909	88	ER800468P	194	ER97012248	240	ERA53	254
ER6548S0001	47	ER74003963	41	ER8053344	73	ER9703438	175	ERA54	254
ER6549S0001	47	ER74004282	48	ER8053421	48	ER9704230	100	ERA55	254
ER65889-4	228	ER74004283	48	ER8053458	33	ER9742945	156	ERA56	254
ER658998	220	ER74005019	17	ER8053595	90	ER9757030	29	ERA57	254
ER6602-01655	161	ER74006182	62	ER8053807	97	ER9757218	54	ERA58	254
ER6610341	48	ER74007095	58	ER8053809	97	ER9758060	29	ERA59	254
ER669291	220	ER74007096	58	ER814362	76	ER9767962	60	ERA60	254
ER6692914	220	ER74007733	88	ER8171413	201	ER98003984	90	ERA61	254
ER6699298	220	ER74007753	58	ER8181694	190	ER98004410	41	ERA62	254
ER6700S0001	15	ER74007774	58	ER8181846	191	ER98005518	41	ERA63	254
ER6700S0011	15	ER74007918	88	ER8182450	181	ER98005574	54	ERA64	254
ER6703S0001	17	ER74008248	28	ER8182862	190	ER98006102	90	ERA65	254
ER6704S0001	18	ER74008821	48	ER8183101	161	ER98006104	90	ERA66	254
ER6704S0002	18	ER74009773	88	ER8189747	33	ER98006897	97	ERA67	254
ER6707S0001	18	ER74010132	88	ER819043	229	ER98007369	41	ERA68	254
ER6707S0002	18	ER74010141	67	ER8193762	156	ER98008321	90	ERA69	254
ER6707S0003	18	ER74010145	38	ER8194001	157	ER98014514	43	ERA70	254
ER6713S0001	18	ER74010146	38	ER819470	203	ER98015087	62	ERA71	254
ER6713S0002	18	ER74010839	88	ER8201799	226	ER98017537	41	ERA72	254
ER675611	156	ER74011242	28	ER8203536	29	ER984177	205	ERA73	254
ER675796	156	ER74011243	29	ER8206229A	107	ER99010033	107	ERA74	254
ER675813	156	ER74011260	89	ER8206230A	109	ER99020272	242	ERA75	254
ER6800	110	ER74011287	89	ER8215557	49	ER99080166	242	ERA76	254
ER688865	171	ER7403P10760	58	ER82486	59	ER99080218	242	ERA77	254
ER691366	169	ER7403P19060	58	ER8272762	90	ER993-475	17	ERA78	254
ER691581	175	ER7403P23860	29	ER8272765	90	ER999509	228	ERA79	254
ER6931EL3001E	165	ER7403P23960	29	ER8272802	90	ERA100	254	ERA80	254
ER6931EL3003D	165	ER7403P25960	59	ER8273004	54	ERA110	254	ERA81	254
ER6S6	116	ER7403P28460	59	ER8273103	90	ERA136	254	ERA82	255
ER6S6DC	116	ER7403P28960	29	ER8273104	90	ERA18	254	ERA83	255
ER700252	220	ER7431P043-60	48	ER8273115	90	ERA19	254	ERA84	255
ER700253	220	ER7431P2760	48	ER8273116	90	ERA20	254	ERA85	255
ER700254	220	ER7431P2760K	48	ER8273992	22	ERA21	254	ERA86	255
ER700255	220	ER7470	95	ER8286034BL	90	ERA22	254	ERA87	255
ER700256	220	ER7472	95	ER8318084	189	ERA23	254	ERA88	255
ER700471	220	ER7501P13660	66	ER838141	220	ERA24	254	ERA89	255
ER700472	220	ER7502P18760	54	ER848395	220	ERA25	254	ERA90	255
ER700473	220	ER7505P17260	38	ER85114	191	ERA26	254	ERA91	255
ER700481	220	ER7505P17360	38	ER8531669	157	ERA27	254	ERA92	255
ER700482	220	ER759296	199	ER8531670	157	ERA28	254	ERA93	255
ER700483	220	ER767A361	246	ER8531671	157	ERA29	254	ERA94	255
ER700484	220	ER7711P13560	89	ER8531964	172	ERA30	254	ERA95	255
ER7080	32	ER7711P15260	89	ER8536974	170	ERA31	254	ERA96	255
ER71001641	88	ER7711P31160	89	ER8540101	181	ERA32	254	ERA97	255

# INDEX

ERP #	PG #	ERP #	PG #	ERP #	PG#	ERP #	PG #	ERP #	PG #
ERADQ36006102.....	200	ERB32 .....	255	ERB58 .....	255	ERB858 .....	8	ERB858 .....	8
ERAT012 .....	162	ERB3200 .....	10	ERB580 .....	5	ERB86 .....	255	ERB86 .....	255
ERAT013 .....	162	ERB33 .....	255	ERB584 .....	5	ERB87 .....	255	ERB87 .....	255
ERAT014 .....	162	ERB3301 .....	10	ERB5862 .....	11	ERB871 .....	8	ERB871 .....	8
ERAT015 .....	162	ERB34 .....	255	ERB59 .....	255	ERB88 .....	255	ERB88 .....	255
ERAT021 .....	162	ERB35 .....	255	ERB5900 .....	11	ERB89 .....	255	ERB89 .....	255
ERAT022 .....	162	ERB36 .....	255	ERB60 .....	255	ERB90 .....	255	ERB90 .....	255
ERAT413 .....	47	ERB37 .....	255	ERB61 .....	255	ERB91 .....	255	ERB91 .....	255
ERAX26 .....	255	ERB38 .....	255	ERB613 .....	5	ERB92 .....	255	ERB92 .....	255
ERAX31 .....	255	ERB3800 .....	10	ERB62 .....	255	ERB93 .....	255	ERB93 .....	255
ERAX33 .....	255	ERB39 .....	255	ERB620 .....	5	ERB94 .....	255	ERB94 .....	255
ERAX34 .....	255	ERB40 .....	255	ERB63 .....	255	ERB95 .....	255	ERB95 .....	255
ERAX35 .....	255	ERB41 .....	255	ERB64 .....	255	ERB96 .....	255	ERB96 .....	255
ERAX36 .....	255	ERB4107 .....	10	ERB640 .....	5	ERB97 .....	255	ERB97 .....	255
ERAX37 .....	255	ERB42 .....	255	ERB641 .....	5	ERB978 .....	8	ERB978 .....	8
ERAX38 .....	255	ERB43 .....	255	ERB65 .....	255	ERB979 .....	9	ERB979 .....	9
ERAX42 .....	255	ERB44 .....	255	ERB651 .....	6	ERB98 .....	255	ERB98 .....	255
ERAX51 .....	255	ERB44K10002 .....	2	ERB66 .....	255	ERB980 .....	9	ERB980 .....	9
ERAX54 .....	255	ERB44K10005 .....	2	ERB67 .....	255	ERB985 .....	9	ERB985 .....	9
ERAX60 .....	255	ERB44K10019 .....	2	ERB672 .....	6	ERB987 .....	9	ERB987 .....	9
ERB0213 .....	9	ERB44K5009 .....	2	ERB68 .....	255	ERB99 .....	255	ERB99 .....	255
ERB0750 .....	9	ERB44K5012 .....	2	ERB680 .....	6	ERBPS22 .....	165	ERBPS22 .....	165
ERB0766 .....	9	ERB44K5013 .....	2	ERB681 .....	6	ERBPS22 .....	231	ERBPS22 .....	231
ERB100 .....	255	ERB44T10009 .....	2	ERB69 .....	255	ERBX50 .....	255	ERBX50 .....	255
ERB103 .....	255	ERB44T10010 .....	2	ERB70 .....	255	ERBX51 .....	255	ERBX51 .....	255
ERB105 .....	255	ERB44T10011 .....	2	ERB700 .....	6	ERBX53 .....	255	ERBX53 .....	255
ERB106 .....	255	ERB44T10014 .....	3	ERB701 .....	6	ERBX70 .....	255	ERBX70 .....	255
ERB108 .....	255	ERB44T10017 .....	3	ERB7019 .....	11	ERD103 .....	213	ERD103 .....	213
ERB1094 .....	9	ERB44T10018 .....	3	ERB71 .....	255	ERD109 .....	213	ERD109 .....	213
ERB110 .....	255	ERB44X10009 .....	4	ERB716 .....	6	ERD110 .....	213	ERD110 .....	213
ERB1117 .....	9	ERB44X10013 .....	4	ERB72 .....	255	ERD111 .....	213	ERD111 .....	213
ERB112 .....	255	ERB44X10015 .....	4	ERB73 .....	255	ERD112 .....	213	ERD112 .....	213
ERB116 .....	255	ERB44X10016 .....	5	ERB7340 .....	11	ERD113 .....	213	ERD113 .....	213
ERB118 .....	255	ERB44X10027 .....	5	ERB74 .....	255	ERD114 .....	213	ERD114 .....	213
ERB120 .....	255	ERB44X10028 .....	5	ERB75 .....	255	ERD115 .....	213	ERD115 .....	213
ERB124 .....	255	ERB44X126 .....	3	ERB76 .....	255	ERD7092602Q .....	220	ERD7092602Q .....	220
ERB126 .....	255	ERB44X127 .....	3	ERB77 .....	255	ERD7092608Q .....	220	ERD7092608Q .....	220
ERB128 .....	255	ERB44X134 .....	3	ERB775 .....	6	ERD7092609Q .....	220	ERD7092609Q .....	220
ERB130 .....	255	ERB44X139 .....	3	ERB776 .....	6	ERD7251020Q .....	220	ERD7251020Q .....	220
ERB131 .....	255	ERB44X173 .....	3	ERB777 .....	7	ERD7605106Q .....	220	ERD7605106Q .....	220
ERB133 .....	255	ERB44X195 .....	3	ERB778 .....	7	ERD7605107Q .....	220	ERD7605107Q .....	220
ERB136 .....	255	ERB44X200 .....	3	ERB779 .....	7	ERD7605109Q .....	220	ERD7605109Q .....	220
ERB140 .....	255	ERB44X228 .....	4	ERB78 .....	255	ERD7605115Q .....	220	ERD7605115Q .....	220
ERB1401018S .....	244	ERB44X232 .....	4	ERB79 .....	255	ERD7605116Q .....	220	ERD7605116Q .....	220
ERB144 .....	255	ERB44X5043 .....	4	ERB790 .....	7	ERD7742204 .....	199	ERD7742204 .....	199
ERB150 .....	192	ERB44X5074 .....	4	ERB798 .....	7	ERD7813010 .....	197	ERD7813010 .....	197
ERB150 .....	255	ERB44X5082 .....	4	ERB80 .....	255	ERDA29-00003G .....	201	ERDA29-00003G .....	201
ERB158 .....	255	ERB44X5099 .....	4	ERB81 .....	255	ERDA31-00103A .....	215	ERDA31-00103A .....	215
ERB162 .....	255	ERB45 .....	255	ERB82 .....	255	ERDA62-00914A .....	198	ERDA62-00914A .....	198
ERB168 .....	255	ERB46 .....	255	ERB825 .....	7	ERDA62-00914B .....	198	ERDA62-00914B .....	198
ERB173 .....	255	ERB47 .....	255	ERB829 .....	7	ERDA62-01477A .....	198	ERDA62-01477A .....	198
ERB195 .....	255	ERB48 .....	255	ERB83 .....	255	ERDA62-01585A .....	198	ERDA62-01585A .....	198
ERB2200 .....	9	ERB4835 .....	10	ERB835 .....	7	ERDC47-00019A .....	194	ERDC47-00019A .....	194
ERB23 .....	255	ERB49 .....	255	ERB837 .....	7	ERDC66-00121A .....	161	ERDC66-00121A .....	161
ERB2395 .....	10	ERB50 .....	255	ERB838 .....	7	ERDE382 .....	165,166,174	ERDE382 .....	165,166,174
ERB2396 .....	10	ERB5002 .....	10	ERB839 .....	8	ERDMWT .....	239	ERDMWT .....	239
ERB24 .....	255	ERB51 .....	255	ERB84 .....	255	ERDW-1 .....	158	ERDW-1 .....	158
ERB25 .....	255	ERB5103 .....	11	ERB841 .....	8	ERDW7 .....	159	ERDW7 .....	159
ERB26 .....	255	ERB52 .....	255	ERB842 .....	8	ERDWLC .....	159	ERDWLC .....	159
ERB27 .....	255	ERB53 .....	255	ERB85 .....	255	ERFWH .....	197	ERFWH .....	197
ERB28 .....	255	ERB54 .....	255	ERB8519 .....	11	ERG1012 .....	98	ERG1012 .....	98
ERB29 .....	255	ERB55 .....	255	ERB853 .....	8	ERG1214 .....	98	ERG1214 .....	98
ERB30 .....	255	ERB550 .....	5	ERB8541 .....	11	ERG1416 .....	98	ERG1416 .....	98
ERB3020 .....	10	ERB56 .....	255	ERB855 .....	8	ERG1820 .....	98	ERG1820 .....	98
ERB31 .....	255	ERB57 .....	255	ERB856 .....	8	ERG2022 .....	98	ERG2022 .....	98
								ERG2224 .....	98
								ERG2427 .....	98
								ERG72 .....	99
								ERGA360 .....	229
								ERGEDWM .....	153
								ERGEIM .....	196
								ERGH264 .....	210
								ERGH274 .....	210
								ERGH276 .....	210
								ERGH278 .....	210
								ERGL2690 .....	211
								ERGNB .....	192
								ERGP1 .....	212
								ERGP11 .....	212
								ERGP20 .....	212
								ERGP21 .....	212
								ERGR205 .....	71
								ERGR403 .....	71
								ERHC-H0609 .....	117
								ERHM101 .....	192
								ERHP363 .....	159
								ERHP403 .....	193
								ERHY10LF286 .....	247
								ERIC100 .....	228
								ERIC102 .....	228
								ERIC103 .....	228
								ERIC13 .....	226
								ERIC15 .....	226
								ERIG0001 .....	70
								ERIG10016 .....	70
								ERIG101 .....	246
								ERIG21 .....	70
								ERIG35 .....	70
								ERIG5067 .....	70
								ERIG5068 .....	70
								ERIG5652 .....	70
								ERIG9159 .....	70
								ERIG9400 .....	71
								ERIG9998 .....	70
								ERKA240 .....	108
								ERL120 .....	162
								ERL125 .....	162
								ERL130 .....	162
								ERL135 .....	162
								ERL140 .....	162
								ERL145 .....	162
								ERL150 .....	162
								ERL155 .....	162
								ERL160 .....	162
								ERL165 .....	162
								ERL170 .....	162
								ERL175 .....	162
								ERL180 .....	162
								ERL190 .....	162
								ERL200 .....	162
								ERL205 .....	162
								ERL225 .....	162
								ERL240 .....	162
								ERL250 .....	162
								ERL260 .....	162
								ERL270 .....	162
								ERL290 .....	162
								ERL300 .....	162
								ERL320 .....	162
								ERL340 .....	162

# INDEX

ERP #	PG #	ERP #	PG #	ERP #	PG#	ERP #	PG #	ERP #	PG #
ERLA1006.....	176	ERR382.....	103	ERUKF8001.....	200	ERWB03X10272.....	85	ERWB20K5018.....	16
ERLA1007.....	169	ERR610045.....	108	ERVA.....	195	ERWB03X10273.....	85	ERWB20K5027.....	16
ERLA1008.....	169	ERR610050.....	110	ERVT.....	238	ERWB03X10274.....	85	ERWB20K5031.....	16
ERLA1044.....	171	ERR9900489.....	174	ERW10001130.....	189	ERWB03X10275.....	85	ERWB20K10004.....	16
ERLA1044.....	193	ERRS65D12.....	22	ERW10006384.....	181	ERWB03X10276.....	85	ERWB20K10010.....	16
ERLA1053.....	173	ERRS85D20.....	22	ERW10072840.....	191	ERWB06X10288.....	108	ERWB20K10013.....	61
ERLA185.....	192	ERRW79.....	193	ERW10107820.....	73	ERWB06X10309.....	107	ERWB20K10023.....	68
ERLH680013.....	247	ERRW79SC.....	193	ERW10107830.....	73	ERWB06X10635.....	52	ERWB20K10026.....	16
ERLH680014.....	247	ERS218.....	21	ERW10119798.....	40	ERWB2K21.....	104	ERWB20X5071.....	16
ERM241.....	216	ERS219.....	21	ERW10120998.....	172	ERWB2X1522.....	99	ERWB21K4.....	52
ERM245.....	216	ERS30K10002.....	22	ERW10134009.....	157	ERWB2X1559.....	107	ERWB21K12.....	52
ERM248.....	216	ERS30K10003.....	22	ERW10134017.....	157	ERWB2X1608.....	103	ERWB21K19.....	52
ERM249.....	216	ERS30M1.....	21	ERW10136934.....	161	ERWB2X2058.....	99	ERWB21K38.....	53
ERM550.....	240	ERS30M2.....	21	ERW10158291.....	157	ERWB2X4267.....	110	ERWB21K39.....	53
ERM551.....	240	ERS30T10074.....	22	ERW10158387.....	157	ERWB2X5103.....	99	ERWB21K10050.....	53
ERM552.....	240	ERS30T10078.....	22	ERW10158389.....	157	ERWB2X7891.....	98	ERWB21X467.....	53
ERM553.....	240	ERS341.....	21	ERW10159016.....	17	ERWB2X7892.....	98	ERWB21X473.....	53
ERM554.....	240	ERS342.....	21	ERW10162890.....	49	ERWB2X7909.....	103	ERWB21X489.....	16
ERM555.....	240	ERS348.....	21	ERW10180213.....	191	ERWB2X8422.....	108	ERWB21X5231.....	61
ERM670.....	241	ERS354.....	21	ERW10180214.....	191	ERWB2X8550.....	104	ERWB21X5273.....	68
ERM671.....	241	ERS356.....	21	ERW10180218.....	191	ERWB2X9883.....	109	ERWB21X5287.....	16
ERM672.....	241	ERS359.....	21	ERW10181986.....	73	ERWB3K100.....	82	ERWB21X10090.....	26
ERM673.....	241	ERS36D12.....	23	ERW10181986.....	73	ERWB3K5069.....	82	ERWB21X10091.....	27
ERM674.....	241	ERS36Y11-120V.....	23	ERW10189703.....	216	ERWB3K5097.....	82	ERWB21X10092.....	16
ERM676.....	241	ERS36Y12.....	23	ERW10190961.....	196	ERWB3K5098.....	82	ERWB21X10098.....	17
ERM678.....	241	ERS46D12.....	23	ERW10190961RK.....	196	ERWB3K5265.....	82	ERWB21X10103.....	61
ERM680.....	241	ERS46D15.....	23	ERW10197679.....	29	ERWB3M26.....	83	ERWB23K5027.....	27
ERM681.....	241	ERS46Y12.....	23	ERW10197681.....	29	ERWB3X464.....	84	ERWB23M2.....	27
ERM682.....	241	ERS46Y15.....	23	ERW10201322.....	104	ERWB3X474.....	84	ERWB23M23.....	27
ERM683.....	242	ERS48D21.....	23	ERW10205415.....	161	ERWB3X5699.....	84	ERWB23M24.....	27
ERM686.....	242	ERS48Y21.....	23	ERW10209656.....	43	ERWB3X5746.....	84	ERWB24K1.....	56
ERM687.....	242	ERS4911.....	117	ERW10252619.....	69	ERWB3X5856.....	84	ERWB24K14.....	56
ERM688.....	242	ERS4912.....	117	ERW10256908.....	95	ERWB3X5857.....	84	ERWB24K30.....	57
ERML45.....	211	ERS58D21.....	23	ERW10258275.....	156	ERWB3X5857.....	84	ERWB24K10002.....	57
ERML50.....	211	ERS58D26-CAN.....	23	ERW10331686.....	49	ERWB3X5858.....	84	ERWB24K10017.....	57
ERML55.....	211	ERS58D26-CAN.....	23	ERW10388414.....	181	ERWB3X5859.....	84	ERWB24T10022.....	27
ERML60.....	211	ERS58Y21.....	23	ERW10388418.....	181	ERWB3X694.....	84	ERWB24T10025.....	27
ERML70.....	211	ERS58Y26.....	23	ERW10536347.....	186	ERWB3X712.....	84	ERWB24T10027.....	27
ERMLT45.....	211	ERSM20.....	45	ERWB02X10700.....	110	ERWB3X714.....	84	ERWB24T10027.....	27
ERMLT50.....	211	ERSM21D.....	45	ERWB02X10733.....	109	ERWB3X716.....	84	ERWB24T10029.....	27
ERMLT55.....	211	ERSM27.....	45	ERWB02X10776.....	109	ERWB3X745.....	84	ERWB24T10058.....	27
ERMLT60.....	211	ERSM40.....	45	ERWB02X10956.....	109	ERWB3X800.....	84	ERWB24T10063.....	27
ERMLT70.....	211	ERSM47.....	45	ERWB02X10980.....	46	ERWB6X486.....	107	ERWB24T10071.....	57
ERMWF.....	201	ERSM47.....	45	ERWB02X11124.....	109	ERWB6X620.....	107	ERWB24T10119.....	27
ERP410.....	225	ERSSD50.....	192	ERWB03K10006.....	82	ERWB7K186.....	105	ERWB24T10153.....	28
ERP6662.....	220	ERSSD6.....	192	ERWB03K10007.....	82	ERWB7K187.....	105	ERWB24X412.....	57
ERP810.....	225	ERSSD6GE.....	192	ERWB03K10034.....	82	ERWB13K10017.....	46	ERWB24X448.....	57
ERPP5.....	225	ERSSD6PF.....	192	ERWB03K10035.....	82	ERWB13K10018.....	46	ERWB24X5252.....	17
ERPP6.....	225	ERSSD8.....	192	ERWB03K10036.....	82	ERWB13K10028.....	46	ERWB24X5285.....	17
ERPR1.....	74	ERSSD8GE.....	192	ERWB03K10053.....	82	ERWB13K10029.....	46	ERWB28K7.....	103
ERPR10.....	74	ERTA302.....	230	ERWB03K10067.....	83	ERWB13M1.....	56	ERWB28K8.....	103
ERPR11.....	74	ERTA47.....	229	ERWB03K10084.....	83	ERWB13X5002.....	108	ERWB28K31.....	104
ERPR2.....	74	ERTA48.....	103	ERWB03K10141.....	83	ERWB13X5004.....	108	ERWB28K10009.....	104
ERPR4.....	74	ERTA53.....	229	ERWB03K10149.....	83	ERWB16K10003.....	40	ERWB28K10010.....	104
ERPR5.....	74	ERTA54.....	105	ERWB03K10201.....	83	ERWB16K10026.....	40	ERWB28K10011.....	104
ERPR6.....	74	ERTB1185.....	239	ERWB03K10204.....	83	ERWB17T10006.....	20	ERWB28K10012.....	104
ERPU410.....	225	ERTB123A.....	195	ERWB03K10302.....	83	ERWB17X5051.....	20	ERWB28K10033.....	103
ERPU810.....	225	ERTB300.....	239	ERWB03K10303.....	83	ERWB17X5113.....	20	ERWB28X111.....	35
ERR0130608.....	108	ERTB301.....	239	ERWB03T10072.....	83	ERWB19K5.....	104	ERWB28X112.....	35
ERR0175012.....	199	ERTC105.....	239	ERWB03T10076.....	83	ERWB19K12.....	65	ERWB29K17.....	40
ERR0175017.....	199	ERTM802.....	239	ERWB03T10129.....	83	ERWB19K31.....	65	ERWB30T10044.....	22
ERR0711030.....	62	ERTP.....	239	ERWB03T10134.....	83	ERWB19K10008.....	67	ERWB30T10045.....	22
ERR0711031.....	62	ERUDB.....	205	ERWB03T10134.....	83	ERWB20K2.....	61	ERWB30T10047.....	22
ERR0711508.....	62	ERUDI.....	165,167,170	ERWB03T10171.....	83	ERWB20K5.....	68	ERWB31K6.....	32
ERR117.....	20	ERUDWD2.....	158	ERWB03T10207.....	83	ERWB20K6.....	68	ERWB31K5027.....	32
		ERUKF7003.....	201	ERWB03X10030.....	84	ERWB20K8.....	68	ERWB31K10012.....	32
				ERWB03X10262.....	84				

# INDEX

ERP #	PG #	ERP #	PG #	ERP #	PG #	ERP #	PG #	ERP #	PG #
ERWB32K3	99	ERWE25X60	168	ERWR8X122	227	ERWR24X445	219	ERWR71X10281	204
ERWB32K5051	99	ERWF1CB	201	ERWR9X208	202	ERWR24X446	219	ERWR71X10282	204
ERWB36K10126	83	ERWF270	201	ERWR9X330DS	212	ERWR24X449	220	ERWR71X2086	229
ERWB48T10095	94	ERWF271	201	ERWR9X355	202	ERWR24X450	220	ERWV-1	194
ERWB48X137	94	ERWFCB	201	ERWR9X405	202	ERWR24X464	220	ERWWHF	197
ERWB48X5094	94	ERWH01X10060	183	ERWR9X411	202	ERWR24X481	220	ERWWHR	197
ERWB48X5099	95	ERWH01X10302	181	ERWR9X480	212	ERWR24X484	220	ERY00206900	17
ERWD08X10057	154	ERWH01X10310	183	ERWR9X481	212	ERWR24X490	220	ERY0042053	59
ERWD7X14	153	ERWH02X10032	183	ERWR9X483	212	ERWR24X524	220	ERY0055029	90
ERWD8X181	153	ERWH1X484	183	ERWR9X489	212	ERWR24X527	220	ERY0057293	90
ERWD8X227	153	ERWH1X1944	183	ERWR9X491	202	ERWR24X528	220	ERY0068689	54
ERWD8X228	153	ERWH1X2026	181	ERWR9X499	203	ERWR24X550	220	ERY0088540	95
ERWD8X229	154	ERWH1X2708	183	ERWR9X501	203	ERWR24X558	220	ERY0088671	96
ERWD9X212	154	ERWH1X2721	183	ERWR9X502	212	ERWR24X5103	220	ERY0089057	91
ERWD12X258	154	ERWH1X2727	183	ERWR9X520	212	ERWR24X5105	220	ERY0308531	38
ERWD12X271	154	ERWH1X2754	183	ERWR9X548	212	ERWR24X5212	220	ERY0308532	38
ERWD12X383	154	ERWH1X2760	183	ERWR13X10020	229	ERWR24X5231	220	ERY0310525	91
ERWD12X10074	154	ERWH1X2788	181	ERWR17X2296	204	ERWR24X5232	220	ERY0310526	91
ERWD12X10136	154	ERWH5X256	184	ERWR17X3691	204	ERWR24X5238	220	ERY0310527	91
ERWD12X10267	154	ERWH8X246	184	ERWR17X3692	204	ERWR24X5258	220	ERY0310974	59
ERWD12X10277	154	ERWH8X281	184	ERWR17X3880	204	ERWR24X10186	220	ERY0312235	96
ERWD12X10304	154	ERWH8X291K	184	ERWR17X3942	204	ERWR24X10228	220	ERY07440901	91
ERWD15X10004	154	ERWH8X305	184	ERWR24X3	219	ERWR24X10229	220	ERY07506601	91
ERWD15X10010	155	ERWH12X494	184	ERWR24X220	219	ERWR24X10231	220	ERY07507301	91
ERWD15X10011	155	ERWH12X1000	185	ERWR24X233	219	ERWR24X10236	220	ERY07517400	33
ERWD19X44	155	ERWH12X1015	185	ERWR24X246	219	ERWR30X10093	196	ERY07540300	33
ERWD19X10032	155	ERWH12X1021	185	ERWR24X260	219	ERWR49X391	208	ERY07580401	97
ERWD21X10060	155	ERWH12X1022	185	ERWR24X261	219	ERWR49X392	208	ERY07589200	91
ERWD22X71	155	ERWH12X1024	185	ERWR24X266	219	ERWR49X393	208	ERY07596101	54
ERWD22X114	155	ERWH12X1026	185	ERWR24X271	219	ERWR50X124	211	ERY07596200	54
ERWD22X120	155	ERWH12X1030	185	ERWR24X272	219	ERWR50X134	211	ERY07659500	69
ERWD24X10018	155	ERWH12X1031	185	ERWR24X273	219	ERWR50X10021	211	ERY07671000	96
ERWD28X10230	155	ERWH12X1034	185	ERWR24X274	219	ERWR50X10068	211	ERY07698800	38
ERWD28X10335	155	ERWH12X1037	185	ERWR24X276	219	ERWR51X413	208	ERY07698900	38
ERWE04X10111	166	ERWH12X10065	184	ERWR24X277	219	ERWR51X419	208	ERY07699100	39
ERWE04X10114	166	ERWH12X10071	185	ERWR24X284	219	ERWR51X442	208	ERY07699200	39
ERWE1M333	167	ERWH12X10338	185	ERWR24X285	219	ERWR51X443	208	ERY07699400	39
ERWE1M481	167	ERWH12X10348	185	ERWR24X286	219	ERWR51X444	208	ERY07699500	39
ERWE1M654	166	ERWH12X10350	185	ERWR24X287	219	ERWR51X465	208	ERY07706900	39
ERWE1X1263	166	ERWH13X10024	185	ERWR24X295	219	ERWR51X466	208	ERY07707000	39
ERWE1X1264	166	ERWH13X10025	185	ERWR24X298	219	ERWR51X10031	208	ERY07707100	39
ERWE1X1269	166	ERWH13X10026	185	ERWR24X300	219	ERWR51X10038	208	ERY07708202	91
ERWE3M19	166	ERWH13X10027	185	ERWR24X301	219	ERWR51X10053	209	ERY07721000	59
ERWE3M26	166	ERWH16X513	184	ERWR24X302	219	ERWR51X10055	209	ERY311946	171
ERWE3X75	166	ERWH23X42	184	ERWR24X303	219	ERWR51X10101	209	ERY700854	91
ERWE4X444	165,167,170	ERWH43X102	184	ERWR24X309	219	ERWR55X10025	211	ERY704512	59
ERWE4X444F	167	ERWIM	196	ERWR24X311	219	ERWR57X77	198	ERY704513	59
ERWE4X739	167	ERWR02X12208	116	ERWR24X312	219	ERWR57X88	198	ERY706012	108
ERWE4X750	167	ERWR07X10131	227	ERWR24X313	219	ERWR57X10032	198	ERZ575	233
ERWE4X800	168	ERWR09X10041	212	ERWR24X315	219	ERWR57X10033	198	ES12	250,251
ERWE11M21C	168	ERWR09X10043	203	ERWR24X317	219	ERWR57X10051	198	ESW-C	250,251
ERWE11M23	168	ERWR09X10049	212	ERWR24X318	219	ERWR57X10082	198	EXT12FT	177
ERWE11X103	168	ERWR09X10074	203	ERWR24X319	219	ERWR60X162	214	FG-AR11	235
ERWE11X203	168	ERWR09X10106	227	ERWR24X389	219	ERWR60X190	214	FLTR012	107
ERWE11X260	168	ERWR09X10107	227	ERWR24X390	219	ERWR60X191	214	FLTR090	110
ERWE11X10007C	168	ERWR09X10124	227	ERWR24X391	219	ERWR60X203	214	FLTR196	108
ERWE12X36	161	ERWR2X4901	229	ERWR24X416	219	ERWR60X10028	215	FRGKLEEN	230
ERWE12X46	161	ERWR2X7232	207	ERWR24X421	219	ERWR60X10129	215	FSWK012	152
ERWE12X49	161	ERWR2X7674	207	ERWR24X422	219	ERWR60X10141	215	FSWK015	152
ERWE12X81	167	ERWR2X7975	207	ERWR24X424	219	ERWR60X10172	215	FSWK016	152
ERWE12X82	161	ERWR2X8345	207	ERWR24X432	219	ERWR62X10055	197	FSWK018	152
ERWE13X68	167	ERWR2X9144	207	ERWR24X433	219	ERWR71X10077	204	FSWK020	152
ERWE18X26	168	ERWR2X9162	207	ERWR24X435	219	ERWR71X10080	204	G13	250
ERWE18X26M	168	ERWR2X9391	229	ERWR24X437	219	ERWR71X10081	204	G20	250
ERWE25X205	168	ERWR2X9393	229	ERWR24X438	219	ERWR71X10106	204	GG12	232

# INDEX

ERP #	PG #	ERP #	PG #	ERP #	PG#	ERP #	PG #	ERP #	PG #
GG66	232	H-EC01	253	LTB512	177	QB-70826	119	SUP-2B	231
GGC-300	105	HG050	247	MLM240	152	QB-70836	119	TF22020	233
GGHS12	232	HM2	249-252	MS-H	231	QB-71224	119	THP-1	195
GL12N	159	HU-4	231	OM112	195	QB-71228	119	TOP1090	101
GZ92	232	HW500	250-252	OM212	195	QB-71233	119	TOP1345	101
H100-3	249,250	IMKR15	199	PHG1	195	QB775	109	TOP135	100
H-214	234	IMKR2	199	PR100	100	QB800	107	TOP246	100
H-2800	253	IMKR25	199	PR3F	100	QB8730	109	TOP579	101
H-2901	253	IMKR6	199	QB0909	108	QB912	107	TOP782	101
H-301	199	K01	250,251	QB0915	108	QB-CF208	110	TR6GE	25
H-316	199	KN001	76	QB0916	108	QBVC	178	TR8GE	25
H45-C	250	KN002	76	QB10299	108	RF-3AMPFB	130	VC-1	247
H55-C	250,252	KN003	76	QB10308	110	RF-5AMPFB	130	W1343	237
H62/85	250,252	KN004	76	QB10309	110	RJR601	177	WB06T	195
H64-C	249,250,252	KN005	76	QB10316	108	S00510	233	WCHARGE	232
H65-C	249,250,252	KN006	76	QB10317	110	S11	252	WCOIL	232
H75-C	249,251,252	KN007	76	QB-10730	119	S-9882	101	WDH6FT	192
HA8	250	KN008	76	QB1110	107	S-9885	101	WDH8FT	192
HC-10702	119	KP-2	195	QB1111	110	S-9891	101	WEB-1	247
HC-H6191	119	KTD01C	237	QB1301	108	S-9892	101	WG-60	233
HC-H6196	119	KTDC	237	QB-200	110	SAB601	237	WM0612N	195
HC-H6230	118	L15	251	QB-210	110	SAB601M	237	WRAC	257
HC-H6231	118	L8-C	251	QB-220	109	SB-32	253	ZC-02	253
HC-H6296	119	LC101	177	QB-230	109	SCEP	249		
HC-L6162	119	LS35	251	QB-240	110	SE906T	105		
HC-L6166	119	LS36	251	QB-250	110	SHUBEE	234		